



BC 2000 DIGITAL

Audio Routing, Mixing and Processing System for
Program Production Centers

HARDWARE MANUAL

ED. 11/14

V 1.1 - 01/12/2016

IMPORTANT NOTE

In order to ensure a good operation of BC-2000 D system a simple maintenance must be done.

In the case of the BC2000DF type chassis, there are 10 fans located on the top that must be kept clean. We recommend to check fans operation at least once a year.



In the case of using ventilation units combined with BC2000DF-3 type chassis, we also recommend to keep fans clean and check their operation at least once a year.

It's also important to keep clean the air holes of rear boards and front cover, as well as the boards connectors.



CONTENTS

1. Introduction: Organization of BC-2000 D system manuals.....	4
2. BC2000DF / BC2000DF-3. System rack.....	5
2.1. Ventilation units.....	6
3. Inputs/outputs, communications and control modules.....	7
3.1. BC2201. Analog line inputs/outputs module.....	7
3.2. BC2202. AES/EBU digital inputs/outputs module.....	10
3.3. BC2203MH. Analog MIC/LIN inputs and headphone outputs module.....	13
3.4. BC2203M. Analog MIC/LIN inputs module.....	16
3.5. BC2203MHL. Analog MIC/LIN inputs and headphone outputs module.....	18
3.6. BC2203ML. Analog MIC/LIN inputs module.....	20
3.7. BC2204. Analog line inputs module.....	22
3.8. BC2205. Analog line outputs module.....	24
3.9. BC2206. AES/EBU digital inputs module.....	26
3.10. BC2207. AES/EBU digital outputs module.....	29
3.11. BC2208. Analog line inputs/outputs module with transformer balanced inputs..	32
3.12. BC2208XF. Analog line inputs/outputs module with transformer balanced.....	34
inputs/outputs.....	
3.13. BC2209. 8 Analog line inputs/outputs module.....	36
3.14. BC2210. Intercom Panels Interfaces module.....	38
3.15. BC2211. AES 10 MAD I module for linking racks.....	40
3.16. BC2212. Dual AES 10 MAD I module for linking racks.....	42
3.17. BC2312. Dual AES 10 MAD I module for linking racks with SFP transceivers....	44
3.18. BC2213. Digital audio transmission module through high speed optical fiber... link.....	46
3.19. BC2214 and BC2224. Multi-channel audio over IP module with Dante protocol of 32 channels (BC2214) or 64 channels (BC2224).....	48
3.20. BC2215. E1/T1/J1 communications module.....	50
3.21. BC2216. Ethernet communications module.....	53
3.22. BC2217. CU (Commentary Unit) linking module.....	55
3.23. BC2219. IP audio inputs/outputs module.....	57
3.24. BC2220 and BC2221. DSP board. Processing, routing and VU meters..... management.....	59
3.25. BC2240. Master Controller Module with USB, Ethernet and RS232/422 port....	61
3.26. BC2250. Front control panel.....	65
4. Power supplies.....	67
4.1. BC2290. 2x300W Power Supply.....	67
4.2. BC2291. 350W Power Supply.....	69
4.3. BC2292. 200W Power Supply Module.....	70
4.4. BC2293. 2x800W Power supply.....	72
5. Standard wiring systems for BC-2000D system.....	74
5.1. Individual connection components.....	74
5.1.1. BC 2000 CAB RACK chassis.....	74
5.1.2. BC 2000 CAB W connection modules.....	75
5.1.3. RJ45 to 4 XLR connection modules.....	76
5.1.4. Cables with connectors.....	77
5.1.5. Loose cables and connectors.....	77
5.2. Wiring kits for BC2000D system.....	78
5.2.1. Standard wiring kit.....	78
5.2.2. Additional control wiring.....	80
6. Switch.....	81
7. Control surfaces.....	82
7.1. ARENA DM control module.....	83
7.2. ARENA D10 channel expansion module.....	85
8. TITAN. Router concentrator 5080 x 5080 audio channels.....	86
9. Additional information.....	90

1. Introduction: Organization of BC-2000 D system manuals.

More than just a product, the **BC-2000 D** is a **System** that must be known at different levels by different types of technicians and users. This is why the information we are providing you is structured in different documents, oriented to different professional profiles.

1. **BC-2000 D console catalogue.** For all professional profiles involved in the purchase and use of the BC-2000 D as a mixing console: prescriber, installer, technical manager, administrator and user.
2. **BC-2000 D matrix/multiplexer catalogue.** For all professional profiles involved in the purchase and use of the BC-2000 D as a switching matrix/audio and data multiplexer: prescriber, installer, technical manager, administrator and user.
3. **Hardware Manual** (this manual). For the professional profiles involved in the installation and technical knowledge of the BC-2000 D as a mixing console or switching matrix/audio and data multiplexer: prescriber, technical manager, installer and administrator.
4. **ARENA DM control surface User's Manual.** Aimed directly at the user of the BC-2000 D as a mixing console, although this manual should also be known at a more basic level by the rest of the professional profiles involved with the BC-2000 D as a mixing console: prescriber, installer, technical manager and administrator.
5. **Configuration software for the BC-2000 D mixing console User's Manual.** This is the fundamental tool for the administrator, and is also highly useful for the mixing console prescriber, installer and technical manager.
6. **Firmware upgrade software User's Manual.** This is a tool meant specifically for the installer and maintenance technician, it can also be used by the administrator under technical department supervision.
7. **Configuration software for the BC-2000 D matrix/multiplexer User's Manual.** In the use of the BC-2000 D as a switching matrix or audio and data multiplexer, the demarcation of roles between technical and user profiles is not that clear. Therefore, this manual and the next one should be known by the various technical profiles involved; in some cases, some material can be extracted from the user's manual for the benefit of low-level users.
8. **Real Time Control software for the BC-2000 D matrix/multiplexer User's Manual.**

2. BC2000DF / BC2000DF-3. System rack.

General description.

This is the chassis that houses the BC-2000 D system printed circuit boards. It is 4 units high and 19" deep. The backpanel and the TDM bus terminal board are integrated into the rack, as well as the system cooling fans (only for BC2000DF chassis).

Composition of the supply.

- Rack with the relevant boards.
- 4-meter speakon/speakon power supply cable.
- 1-meter flexible, shielded, uncrossed local network cable (for connection through switch).

Description of the panels.

The **front section** has 21 slots. The first of these ("A" in the figure below) must be occupied by a load termination board, and the next 20 slots ("B") can accommodate up to 20 DSP boards (**BC2221**). At the right-hand end of the rack ("C") a **BC2250** front control panel could be placed: when this front module is mounted in the system, the rack can accommodate up to 18 DSP boards.

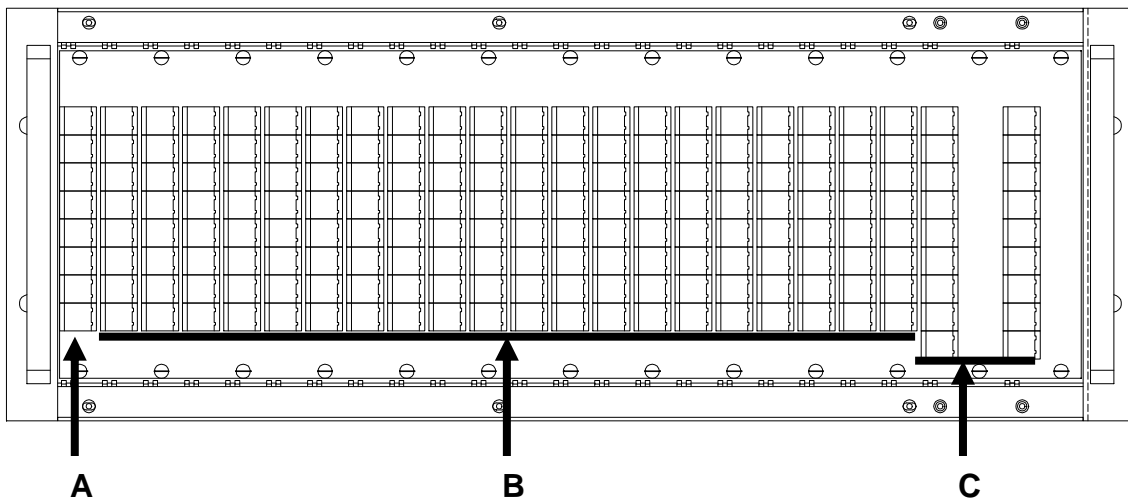

The **rear section** offers 21 slots ("D" in the drawing below) to house up to 16 input/output boards (BC2201, BC2202, BC2203, BC2204, BC2205, BC2206, BC2207, BC2208, BC2209, BC2210, BC2211, BC2212, BC2312, BC2213, BC2214, BC2224, BC2215, BC2216, BC2217 or BC2219) and 1 or 2 power supply modules (BC2292). When there are no **BC2292** modules in the system, the rack can accommodate up to 21 input/output boards. There are two slots at the left end of the chassis ("E") to house one or two **BC2240** controller modules.

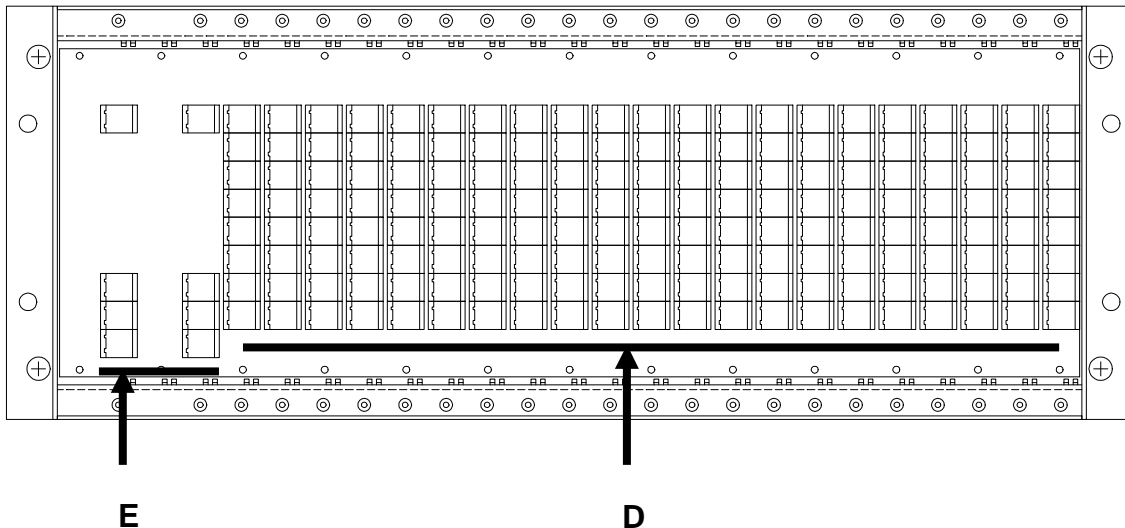

While the boards can be inserted in any position in the rack, we recommend, whenever possible, leaving an empty slot between each pair of boards inserted in the rear panel to facilitate connection and disconnection of the cables and ventilation (by convection in BC2000DF-3 chassis).

Other characteristics and features.

In the case of a BC2000DF-3 chassis, the ventilator fans are mounted so that they can be hot-swapped. To be able to hot-swap the fans, the rack must be mounted on extractor rails.

The backpanel or connection board is completely passive, which eases maintenance. Backpanel breakdowns or failures are highly improbable and can only occur for mechanical reasons.

General characteristics.

- Dimensions: 4 U x 19 " (482 mm x 176 mm x 450 mm).
- Approximate weight: 10,500 grams.

2.1. Ventilation units.

For dense setups with several **BC2000DF-3** type racks, it's necessary to install **forced ventilation units** for a better system cooling. There are 3 kinds of ventilation units, depending on if there are 6 frontal ventilation fans (**BC 2000 FAN DOWN**), 6 rear ventilation fans (**BC 2000 FAN UP**) or 6 frontal and 6 rear ventilation fans (**BC 2000 FAN MIDDLE**).

In a system with several racks placed vertically, one unit of first type (as indicated by its name) will be placed in the lower part of the system for air insertion and one unit of second type will be placed at the top of the system for hot air extraction; in addition, between each pair of racks one unit of third type will be placed in order to extract hot air from the lower rack and insert cold air in the upper one.

Each ventilation unit has 1 unit high and is feeded with 48 volts DC through a connector with SPEAKON type interlock. Approximate consumption is 2 watts for simple units and 4 watts for double units.

3. Inputs/outputs, communications and control modules.

3.1. BC2201. Analog line inputs/outputs module.

General description.

The BC2201 board can manage four TDM IN bus time-slots to insert two analog stereo (or four mono) signals into the system with line level, and four TDM OUT bus time-slots to extract two analog stereo (or four mono) signals from the system with line level.

This board is inserted into the rear part of the BC2000DF rack.

Panel description.

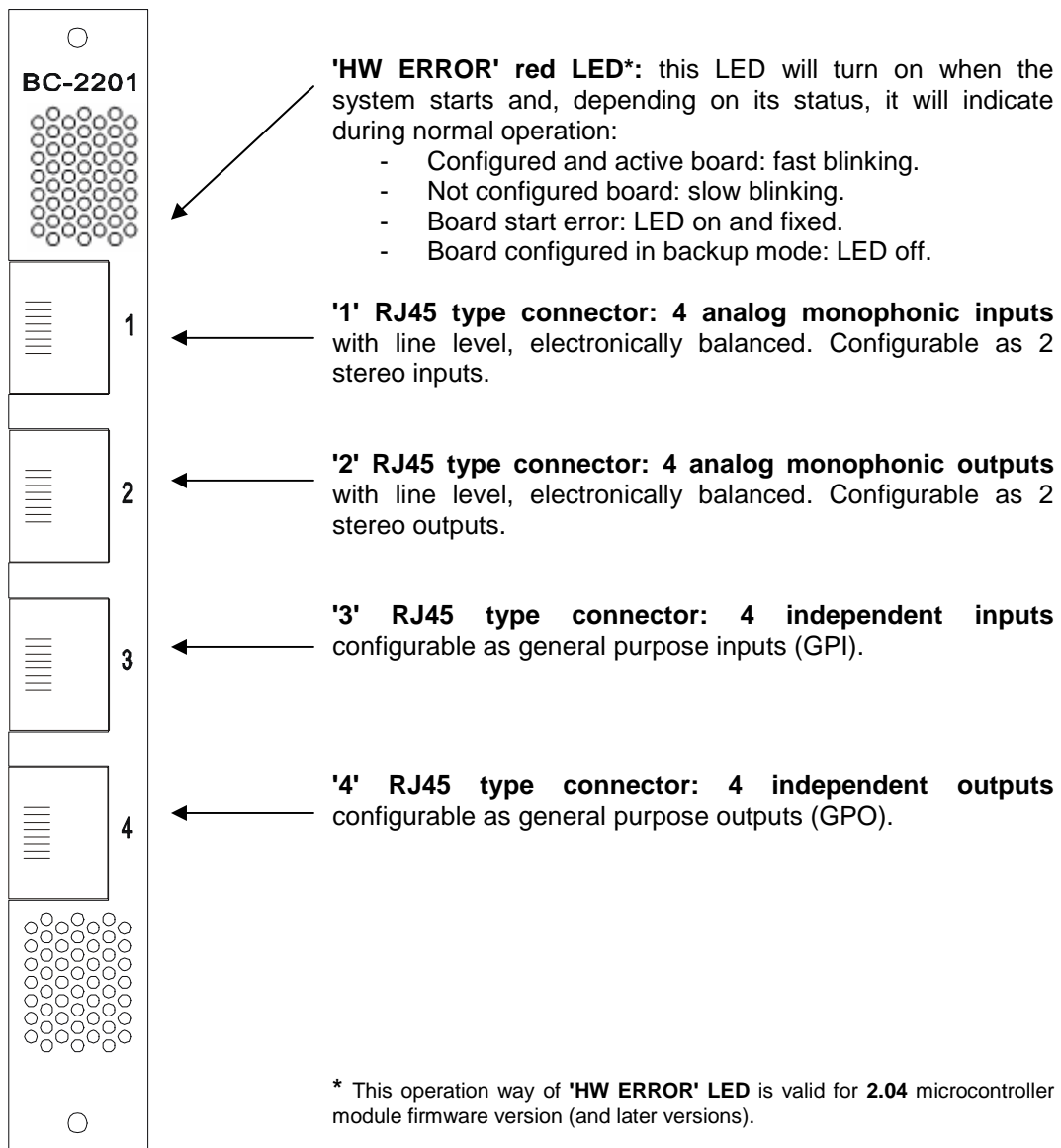

Other characteristics and features.

- Internal warning signal indicating a failure in one of the power supplies. If a failure occurs, the “ALARM” LED on the BC2240 controller board will light up.
- Power feed circuit designed to support hot-swapping operations.
- Digital adjustment of analog gain (± 12 dB) in the 4 inputs and the 4 outputs.
- Digital adjustment of digital gain (± 12 dB) in the 4 inputs and the 4 outputs.

Programming jumpers.

This board has a series of internal programming jumpers (PJ). However, these jumpers are configured at the factory and, in normal operation, do not need to be changed.

Firmware modules.

At the firmware level, this board is made up of the following modules:

- **PIC microcontroller:** manages board communications and start-up.
- **FPGA programmable device:** manages the converters and the TDM bus.

The firmware versions can be brought up to date by using the “**BC2000D Firmware Upgrade**” software application.

Signal layout in the RJ45 connectors of the board.

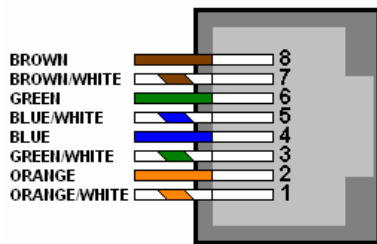

Pin	'1' Inputs	'2' Outputs	'3' GPI	'4' GPO
8	IN 2 (1R) V-	OUT 2 (1R) V-	GND GPI2	GND GPO2
7	IN 2 (1R) V+	OUT 2 (1R) V+	GPI2	GPO2
6	IN 3 (2L) V-	OUT 3 (2L) V-	GND GPI3	GND GPO3
5	IN 4 (2R) V-	OUT 4 (2R) V-	GND GPI4	GND GPO4
4	IN 4 (2R) V+	OUT 4 (2R) V+	GPI4	GPO4
3	IN 3 (2L) V+	OUT 3 (2L) V+	GPI3	GPO3
2	IN 1 (1L) V-	OUT 1 (1L) V-	GND GPI1	GND GPO1
1	IN 1 (1L) V+	OUT 1 (1L) V+	GPI1	GPO1
Chassis	AGND	AGND	AGND	AGND

NOTE: Pin layout corresponds to T568B standard.

BC2201 technical specifications.

Analog inputs:

- 24-bit, 48 kHz A/D converters.
- Nominal input level: +4 dBu (software configurable).
- Maximum input level: +22 dBu.
- Minimum input level: -20 dBu.

Analog outputs:

- 24-bit, 48 kHz D/A converters.
- Nominal output level: +4 dBu.
- Maximum output level: +28 dBu (+22 dBu with nominal adjustment).
- Output stage noise level: -82 dBu.

General audio specifications:

- Bandwidth: 20 to 20,000Hz +/-0.8 Db.
- Distortion: less than 0.09% in the bandwidth.
- Input + output noise level (in audio frequencies): -76 dBu.
- Cross-talk: less than -70 dB in the bandwidth.

GPI inputs:

- Inputs protected by optocoupler (4N35).
- Maximum input current: 60 mA.
- A voltage ranging from 5 V to 30 V will be applied.

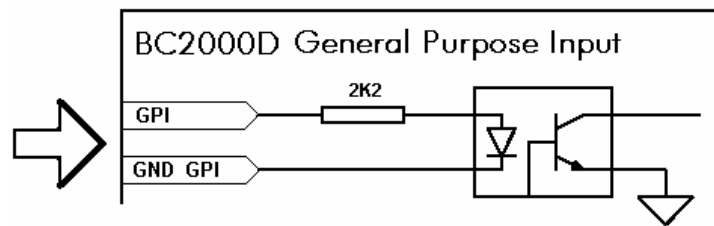

GPO outputs:

- Outputs protected by optocoupler (TLP371).
- Maximum current: 80 mA.
- Recommended maximum voltage: 200 V.
- Maximum power: 250 mW at 40° C.
- Requires external power supply.

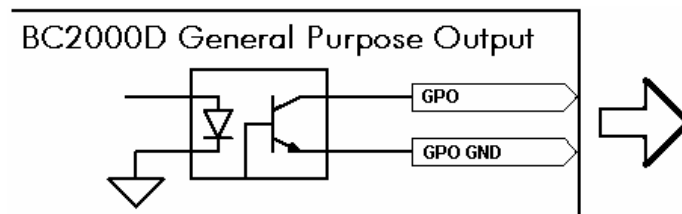

General characteristics.

- Approximate consumption: 9 watts.
- Approximate dimensions:
Front: 17 x 172 mm.
Depth: 255 mm.
- Approximate weight: 315 grams.

Characteristics are subject to change without notice.

3.2. BC2202. AES/EBU digital inputs/outputs module.

General description.

The BC2202 board can manage eight TDM IN bus time-slots to insert four AES3 (or SPDIF) digital stereo signals into the system, and eight TDM OUT bus time-slots to extract four AES3 (or SPDIF) digital stereo signals from the system.

This board is inserted into the rear part of the BC2000DF rack.

Panel description.

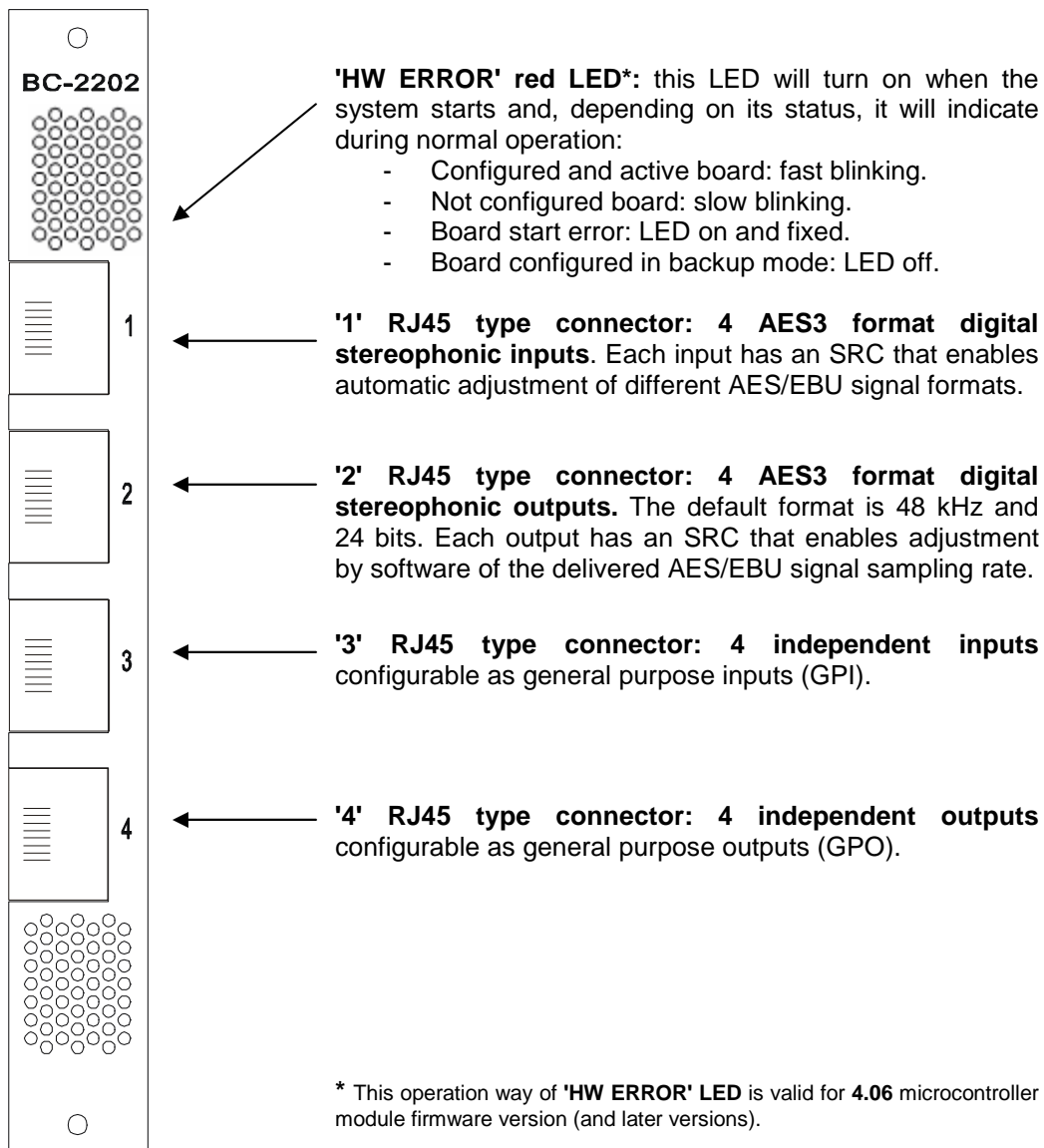

Other characteristics and features.

- Internal warning signal indicating a failure in one of the power supplies. If a failure occurs, the “ALARM” LED on the BC2240 controller board will light up.
- Power feed circuit designed to support hot-swapping operations.
- Digital adjustment of digital gain (± 12 dB) in the 4 inputs and the 4 outputs.
- Possibility of converting the module so that it can use SPDIF signals by manipulating the internal programming jumpers.

Programming jumpers.

This board is equipped with a series of internal programming jumpers (PJ) that allow you to change the format of the digital signal to be used between AES3 and SPDIF. You can independently change the format of each one of the four audio channels (circuit 0, 1, 2 and 3) by changing the following PJs:

CN12, CN13, CN16, CN18, CN22 → AES3 / SPDIF digital audio selectors, input circuit 0.

CN17, CN23, CN25, CN55 → AES3 / SPDIF digital audio selectors, output circuit 0.

1-2: AES3 Digital Audio.

2-3: SPDIF Digital Audio.

CN24, CN31, CN32, CN33, CN38 → AES3 / SPDIF digital audio selectors, input circuit 1.

CN30, CN39, CN40, CN56 → AES3 / SPDIF digital audio selectors for output circuit 1.

1-2: AES3 Digital Audio.

2-3: SPDIF Digital Audio.

CN14, CN15, CN19, CN21, CN26 → AES3 / SPDIF digital audio selectors, input circuit 2.

CN20, CN27, CN29, CN57 → AES3 / SPDIF digital audio selectors, output circuit 2.

1-2: AES3 Digital Audio.

2-3: SPDIF Digital Audio.

CN28, CN35, CN36, CN37, CN41 → AES3 / SPDIF digital audio selectors, input circuit 3.

CN34, CN42, CN43, CN58 → AES3 / SPDIF digital audio selectors, output circuit 3.

1-2: AES3 Digital Audio.

2-3: SPDIF Digital Audio.

The default position of these PJs is 1-2; that is, they are configured to work with digital audio in AES/EBU format.

Firmware modules.

At the firmware level, this board is made up of the following modules:

- **PIC microcontroller:** manages board communications and start-up.
- **FPGA programmable device:** manages SRCs and the TDM bus.

The firmware versions can be brought up to date by using the “**BC2000D Firmware Upgrade**” software application.

Signal layout in the RJ45 connectors of the board.

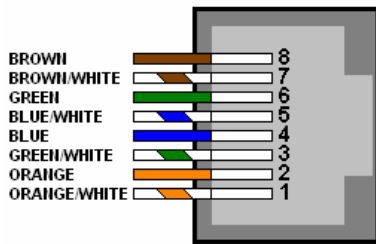

Pin	'1' Inputs	'2' Outputs	'3' GPI	'4' GPO
8	IN 2 N	OUT 2 N	GND GPI2	GND GPO2
7	IN 2 P	OUT 2 P	GPI2	GPO2
6	IN 3 N	OUT 3 N	GND GPI3	GND GPO3
5	IN 4 N	OUT 4 N	GND GPI4	GND GPO4
4	IN 4 P	OUT 4 P	GPI4	GPO4
3	IN 3 P	OUT 3 P	GPI3	GPO3
2	IN 1 N	OUT 1 N	GND GPI1	GND GPO1
1	IN 1 P	OUT 1 P	GPI1	GPO1
Chassis	GND	GND	GND	GND

NOTE: Pin layout corresponds to T568B standard.

BC2202 technical specifications.

Digital inputs:

- Isolated by transformer.
- SRC converters accept signal at 32, 44.1, 48 and 96 kHz and 16, 20 or 24 bits.

Digital outputs:

- Default digital signal format: 24 bits, 48 kHz. The outputs are equipped also with SRC converters that can deliver signal at 32, 44.1, 48 and 96 kHz (software configurable).

GPI inputs:

- Inputs protected by optocoupler (4N35).
- Maximum input current: 60 mA.
- A voltage ranging from 5 V to 30 V will be applied.

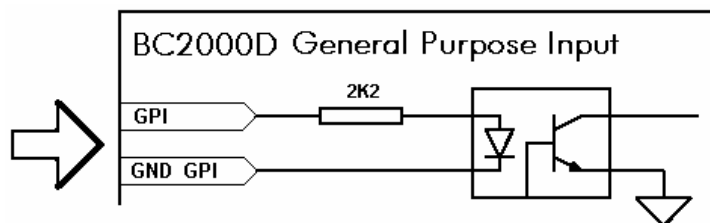

GPO outputs:

- Outputs protected by optocoupler (TLP371).
- Maximum current: 80 mA.
- Recommended maximum voltage: 200 V.
- Maximum power: 250 mW at 40° C.
- Requires external power supply.

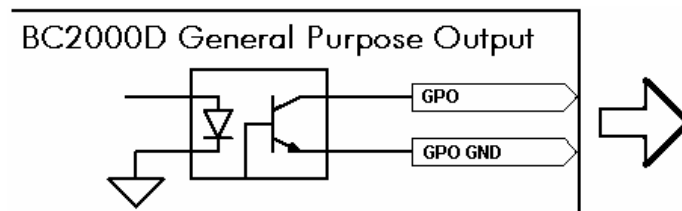

General characteristics.

- Approximate consumption: 4 watts.
- Approximate dimensions:
Front: 17 x 172 mm.
Depth: 255 mm.
- Approximate weight: 295 grams.

Characteristics are subject to change without notice.

3.3. BC2203MH. Analog MIC/LIN inputs and headphone outputs module.

General description.

The BC2203MH board is capable of managing four TDM IN bus time-slots to insert four analog mono signals into the system with mic or line level, and can furnish 48 volts of PHANTOM power to the microphones that require it. It also manages four TDM OUT bus time-slots to extract two signals from the system for two stereo headphones.

This board is inserted into the rear part of the BC2000DF rack, where it occupies two slots.

Panel description.

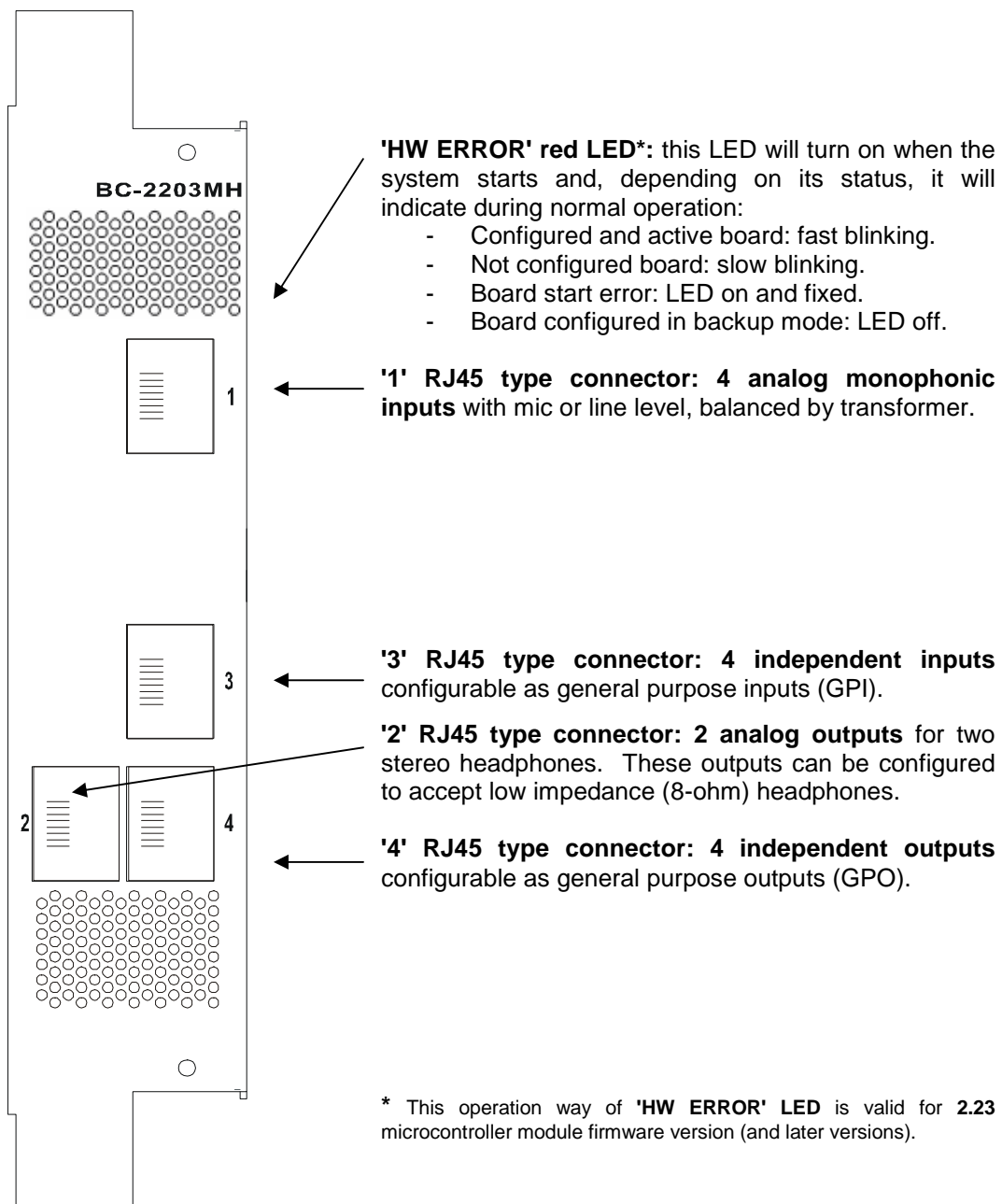

Other characteristics and features.

- Internal warning signal indicating a failure in one of the power supplies. If a failure occurs, the “ALARM” LED on the BC2240 controller board will light up.
- Power feed circuit designed to support hot-swapping operations.
- Digital adjustment of analog gain (± 12 dB) in the 4 inputs.
- Digital adjustment of digital gain (-40/+24 dB) in the 4 inputs.

Programming jumpers.

This board has a series of internal programming jumpers (PJ). By default, this board is configured to work with high impedance headphones (higher than 150 Ω). If you use low impedance headphones (below 150 Ω), you will need to pull the board out and change the J1, J2, J3 and J4 jumpers on the board marked "472-001-311" to position 2-3.

Firmware modules.

At the firmware level, this board is made up of the following modules:

- **PIC microcontroller:** manages board communications and start-up.
- **FPGA programmable device:** manages the converters and the TDM bus.

The firmware versions can be brought up to date by using the “**BC2000D Firmware Upgrade**” software application.

Signal layout in the RJ45 connectors of the board.

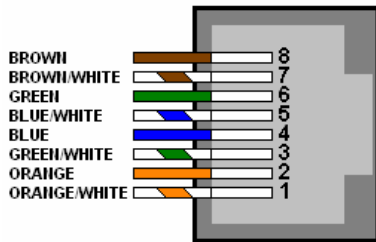

Pin	'1' Inputs	'2' Outputs	'3' GPI	'4' GPO
8	IN 2 V-	HP 1 GND	GND GPI2	GND GPO2
7	IN 2 V+	HP 1R	GPI2	GPO2
6	IN 3 V-	HP 2 GND	GND GPI3	GND GPO3
5	IN 4 V-	HP 2 GND	GND GPI4	GND GPO4
4	IN 4 V+	HP 2R	GPI4	GPO4
3	IN 3 V+	HP 2L	GPI3	GPO3
2	IN 1 V-	HP 1 GND	GND GPI1	GND GPO1
1	IN 1 V+	HP 1L	GPI1	GPO1
Chassis	AGND	AGND	AGND	AGND

NOTE: Pin layout corresponds to T568B standard.

BC2203MH technical specifications.

Analog inputs:

- 24-bit, 48 kHz A/D converters.
- PHANTOM power supply voltage: +48 V (software configurable).

Analog outputs:

- 24-bit, 48 kHz D/A converters.
- Capacity to feed high and low impedance headphones.

Bandwidth:

- Mic and line inputs: 40-20,000 Hz @ +/- 0.5 dB.
20-20,000 Hz @ +/-1.5 dB.

Distortion:

- Mic and line inputs (nominal levels): < 0.1% @ 50-20,000 Hz.
< 0.39% @ 20-20,000 Hz.

Noise:

- Microphone inputs: Equivalent noise: < -122 dBu @ G = +52 dB.
- Line inputs: Absolute noise: < -77 dBu.

Cross-talk:

- Between line inputs: < -74 dB @ 20-20,000 Hz.
- Line inputs on microphone inputs: < -38 dB @ 20-20,000 Hz.
- Between microphone inputs: < -78 dB @ 20-20,000 Hz.
- Between headsets:
 - 600 Ohm.: < -70 dB @ 20-20,000 Hz.
 - 10 Ohm.: < -50 dB @ 20-20,000 Hz.
- Headset outputs on microphone inputs:
 - 600 Ohm.: < -50 dB @ 20-20,000 Hz.
 - 10 Ohm.: < -34 dB @ 20-20,000 Hz.
- Headset outputs on line inputs:
 - 600 Ohm.: < -71 dB @ 20-20,000 Hz.
 - 10 Ohm.: < -74 dB @ 20-20,000 Hz.

Input range:

- Microphone inputs: -72 dBu ----- -27 dBu.
- Line inputs: -20 dBu ----- +22 dBu.

GPI inputs:

- Inputs protected by optocoupler (4N35).
- Maximum input current: 60 mA.
- A voltage ranging from 5 V to 30 V will be applied.

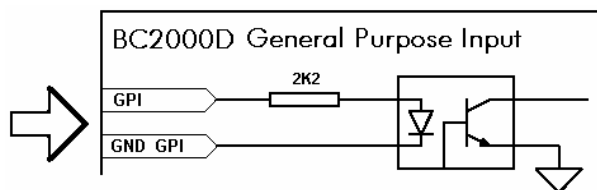

GPO outputs:

- Outputs protected by optocoupler (TLP371).
- Maximum current: 80 mA.
- Recommended maximum voltage: 200 V.
- Maximum power: 250 mW at 40° C.
- Requires external power supply.

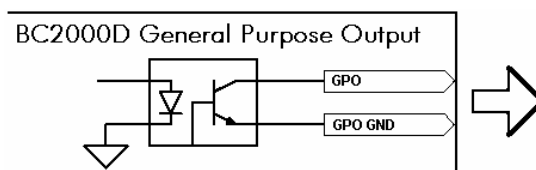

General characteristics.

- Approximate consumption: 7.5 watts.
- Approximate dimensions:
 - Front: 34 x 172 mm.
 - Depth: 255 mm.
- Approximate weight: 560 grams.

Characteristics are subject to change without notice.

3.4. BC2203M. Analog MIC/LIN inputs module.

General description.

The BC2203M board is capable of managing four TDM IN bus time-slots to insert four analog mono signals into the system with mic or line level, and can furnish 48 volts of PHANTOM power to the microphones that require it.

This board is inserted into the rear part of the BC2000DF rack.

Panel description.

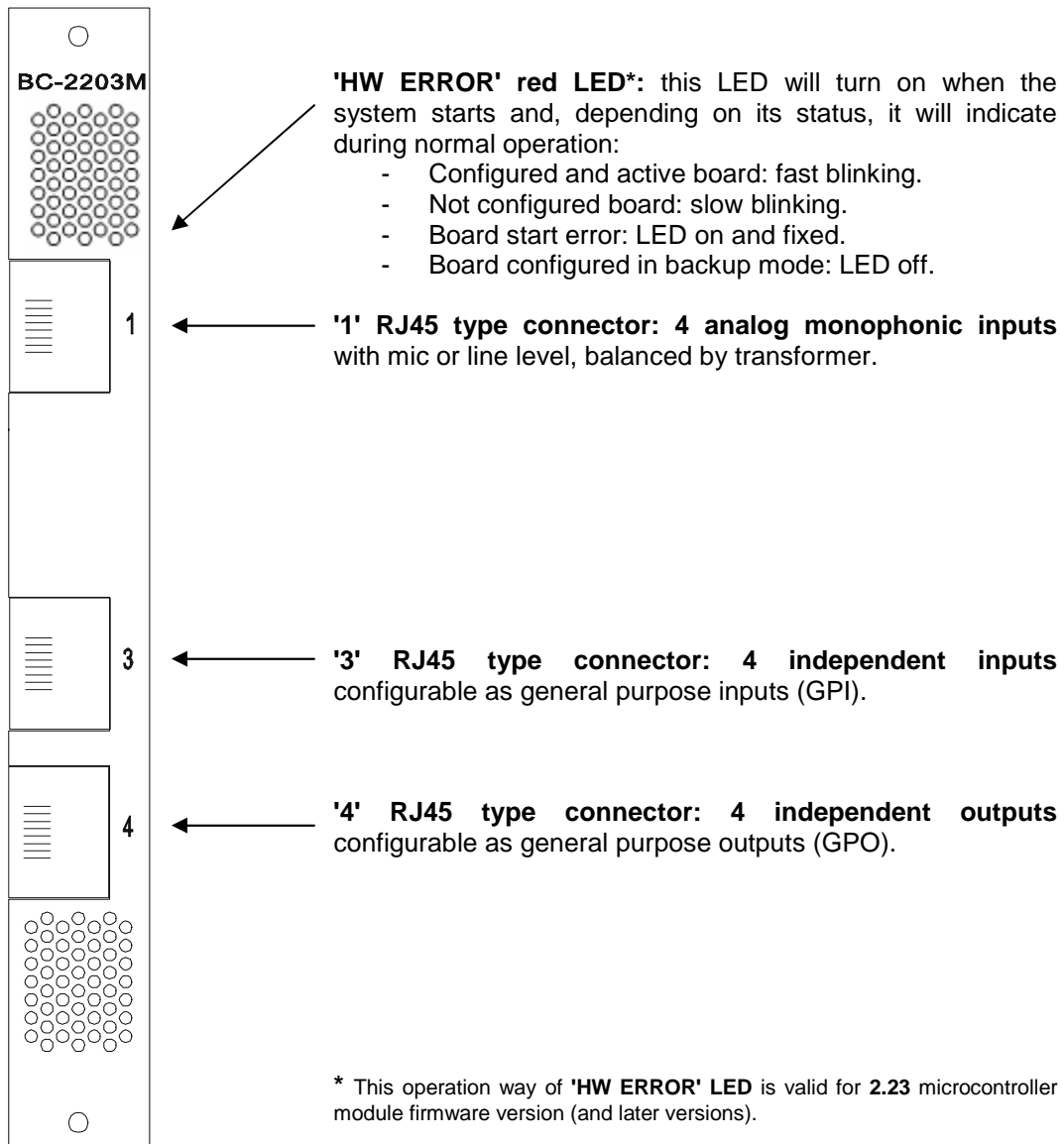

Other characteristics and features.

- Internal warning signal indicating a failure in one of the power supplies. If a failure occurs, the "ALARM" LED on the BC2240 controller board will light up.
- Power feed circuit designed to support hot-swapping operations.
- Digital adjustment of analog gain (± 12 dB) in the 4 inputs.
- Digital adjustment of digital gain (-40/+24dB) in the 4 inputs.

Programming jumpers.

This board has a series of internal programming jumpers (PJ). However, these jumpers are configured at the factory and, in normal operation, do not need to be changed.

Firmware modules.

At the firmware level, this board is made up of the following modules:

- **PIC microcontroller:** manages board communications and start-up.
- **FPGA programmable device:** manages the converters and the TDM bus.

The firmware versions can be brought up to date by using the "BC2000D Firmware Upgrade" software application.

Signal layout in the RJ45 connectors of the board.

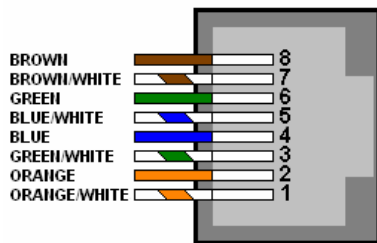

Pin	'1' Inputs	-	'3' GPI	'4' GPO
8	IN 2 V-	-	GND GPI2	GND GPO2
7	IN 2 V+	-	GPI2	GPO2
6	IN 3 V-	-	GND GPI3	GND GPO3
5	IN 4 V-	-	GND GPI4	GND GPO4
4	IN 4 V+	-	GPI4	GPO4
3	IN 3 V+	-	GPI3	GPO3
2	IN 1 V-	-	GND GPI1	GND GPO1
1	IN 1 V+	-	GPI1	GPO1
Chassis	AGND	-	AGND	AGND

NOTE: Pin layout corresponds to T568B standard.

BC2203M technical specifications.

See BC2203MH module specifications.

General characteristics.

- Approximate consumption: 6 watts.
- Approximate dimensions:
 - Front: 17 x 172 mm.
 - Depth: 255 mm.
- Approximate weight: 400 grams.

Characteristics are subject to change without notice.

3.5. BC2203MHL. Analog MIC/LIN inputs and headphone outputs module.

General description.

The BC2203MHL board is capable of managing four TDM IN bus time-slots to insert four analog mono signals into the system with mic or line level, and can furnish 48 volts of PHANTOM power to the microphones that require it. It also manages four TDM OUT bus time-slots to extract two signals from the system for two stereo headphones.

This board is inserted into the rear part of the BC2000DF rack, where it occupies two slots.

Panel description.

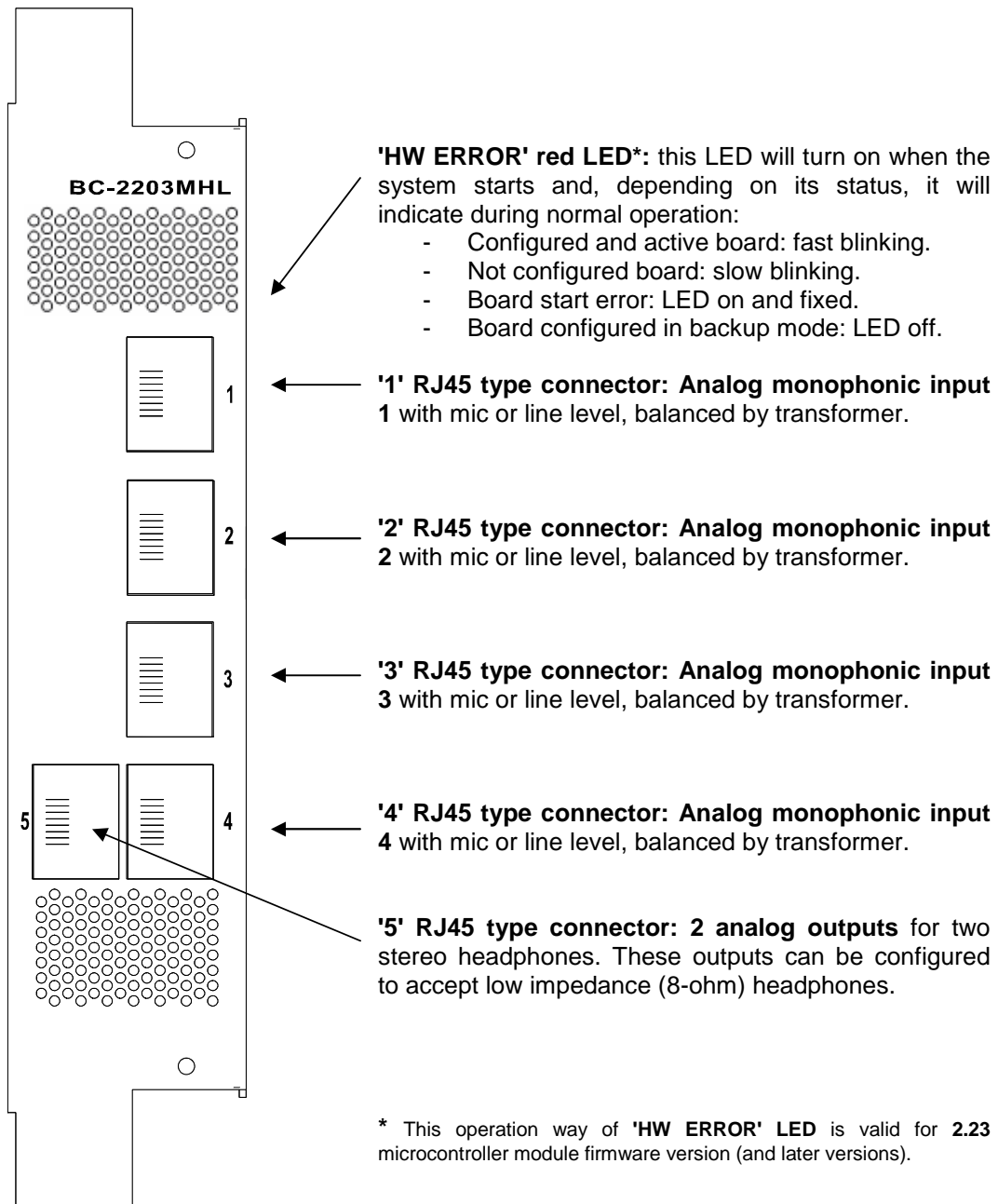

Other characteristics and features.

- Internal warning signal indicating a failure in one of the power supplies. If a failure occurs, the “ALARM” LED on the BC2240 controller board will light up.
- Power feed circuit designed to support hot-swapping operations.
- Digital adjustment of analog gain (± 12 dB) in the 4 inputs.
- Digital adjustment of digital gain (-40/+24 dB) in the 4 inputs.

Programming jumpers.

This board has a series of internal programming jumpers (PJ). By default, this board is configured to work with high impedance headphones (higher than 150 Ω). If you use low impedance headphones (below 150 Ω), you will need to pull the board out and change the J1, J2, J3 and J4 jumpers on the board marked "472-001-311" to position 2-3.

Firmware modules.

At the firmware level, this board is made up of the following modules:

- **PIC microcontroller:** manages board communications and start-up.
- **FPGA programmable device:** manages the converters and the TDM bus.

The firmware versions can be brought up to date by using the “BC2000D Firmware Upgrade” software application.

Signal layout in the RJ45 connectors of the board.

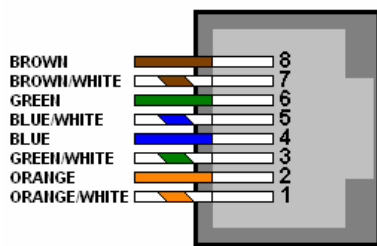

Pin	'1' Input 1	'2' Input 2	'3' Input 3	'4' Input 4	'5' Outputs
8					HP1 GND
7					HP1 R
6					HP2 GND
5	IN 1 V-	IN 2 V-	IN 3 V-	IN 4 V-	HP2 GND
4	IN 1 V+	IN 2 V+	IN 3 V+	IN 4 V+	HP2 R
3					HP2 L
2					HP1 GND
1					HP1 L
Chassis	AGND	AGND	AGND	AGND	AGND

NOTE: Pin layout corresponds to T568B standard.

BC2203MHL technical specifications.

Analog inputs:

- 24-bit, 48 kHz A/D converters.
- PHANTOM power supply voltage: +48 V (software configurable).

Analog outputs:

- 24-bit, 48 kHz D/A converters.
- Capacity to feed high and low impedance headphones.

General characteristics.

- Approximate consumption: 7.5 watts.
- Approximate dimensions:
Front: 34 x 172 mm.
Depth: 255 mm.
- Approximate weight: 560 grams.

Characteristics are subject to change without notice.

3.6. BC2203ML. Analog MIC/LIN inputs module.

General description.

The BC2203ML board is capable of managing four TDM IN bus time-slots to insert four analog mono signals into the system with mic or line level, and can furnish 48 volts of PHANTOM power to the microphones that require it.

This board is inserted into the rear part of the BC2000DF rack.

Panel description.

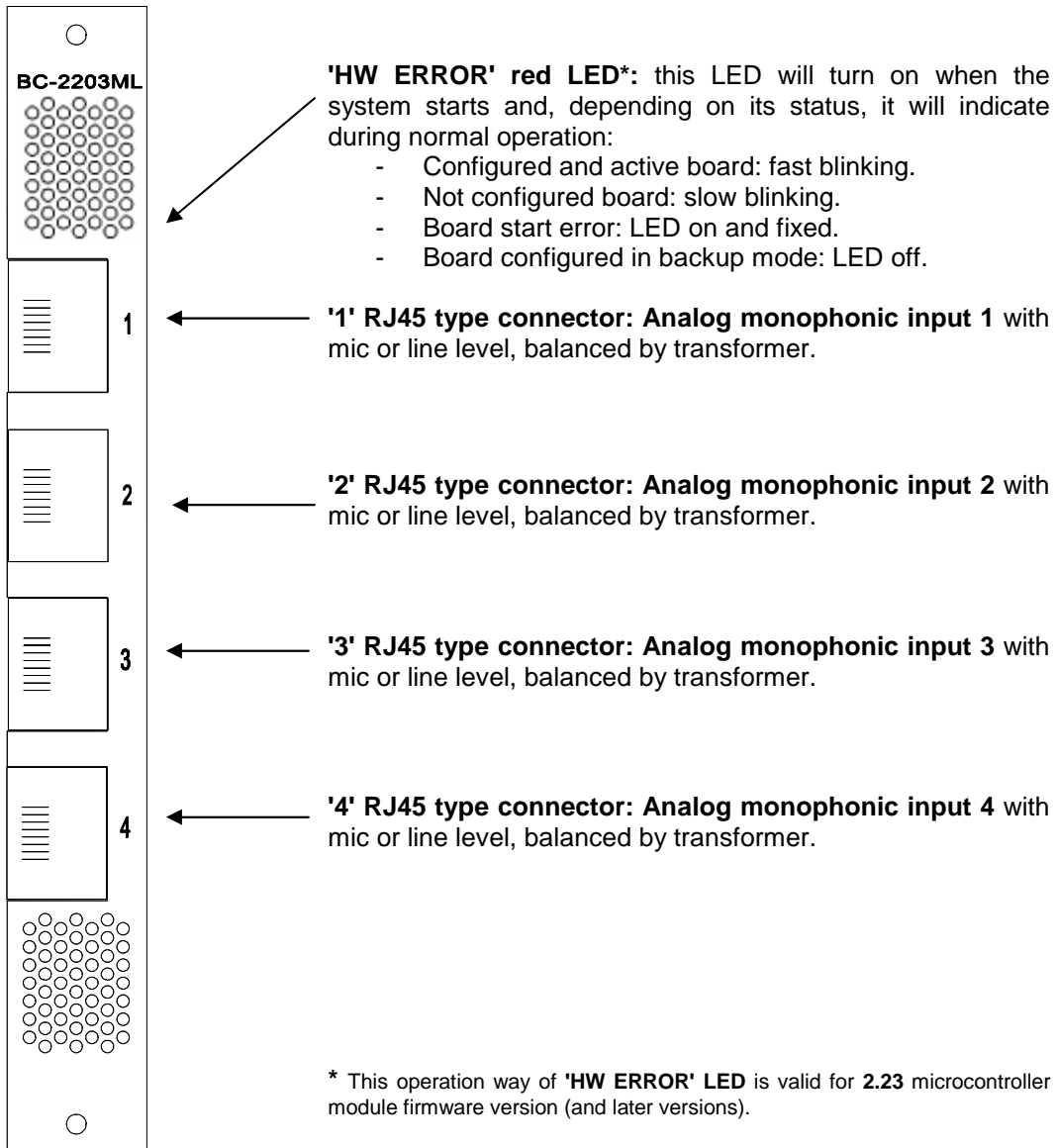

Other characteristics and features.

- Internal warning signal indicating a failure in one of the power supplies. If a failure occurs, the "ALARM" LED on the BC2240 controller board will light up.
- Power feed circuit designed to support hot-swapping operations.
- Digital adjustment of analog gain (± 12 dB) in the 4 inputs.
- Digital adjustment of digital gain (-40/+24dB) in the 4 inputs.

Programming jumpers.

This board has a series of internal programming jumpers (PJ). However, these jumpers are configured at the factory and, in normal operation, do not need to be changed.

Firmware modules.

At the firmware level, this board is made up of the following modules:

- **PIC microcontroller:** manages board communications and start-up.
- **FPGA programmable device:** manages the converters and the TDM bus.

The firmware versions can be brought up to date by using the "BC2000D Firmware Upgrade" software application.

Signal layout in the RJ45 connectors of the board.

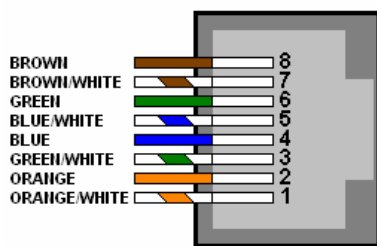

Pin	'1' Input 1	'2' Input 2	'3' Input 3	'4' Input 4
8				
7				
6				
5	IN 1 V-	IN 2 V-	IN 3 V-	IN 4 V-
4	IN 1 V+	IN 2 V+	IN 3 V+	IN 4 V+
3				
2				
1				
Chassis	AGND	AGND	AGND	AGND

NOTE: Pin layout corresponds to T568B standard.

BC2203ML technical specifications.

See BC2203MHL module specifications.

General characteristics.

- Approximate consumption: 6 watts.
- Approximate dimensions:
Front: 17 x 172 mm.
Depth: 255 mm.
- Approximate weight: 400 grams.

Characteristics are subject to change without notice.

3.7. BC2204. Analog line inputs module.

General description.

The BC2204 board can manage four TDM IN bus time-slots to insert two analog stereo (or four mono) signals into the system with line level.

This board is inserted into the rear part of the BC2000DF rack.

Panel description.

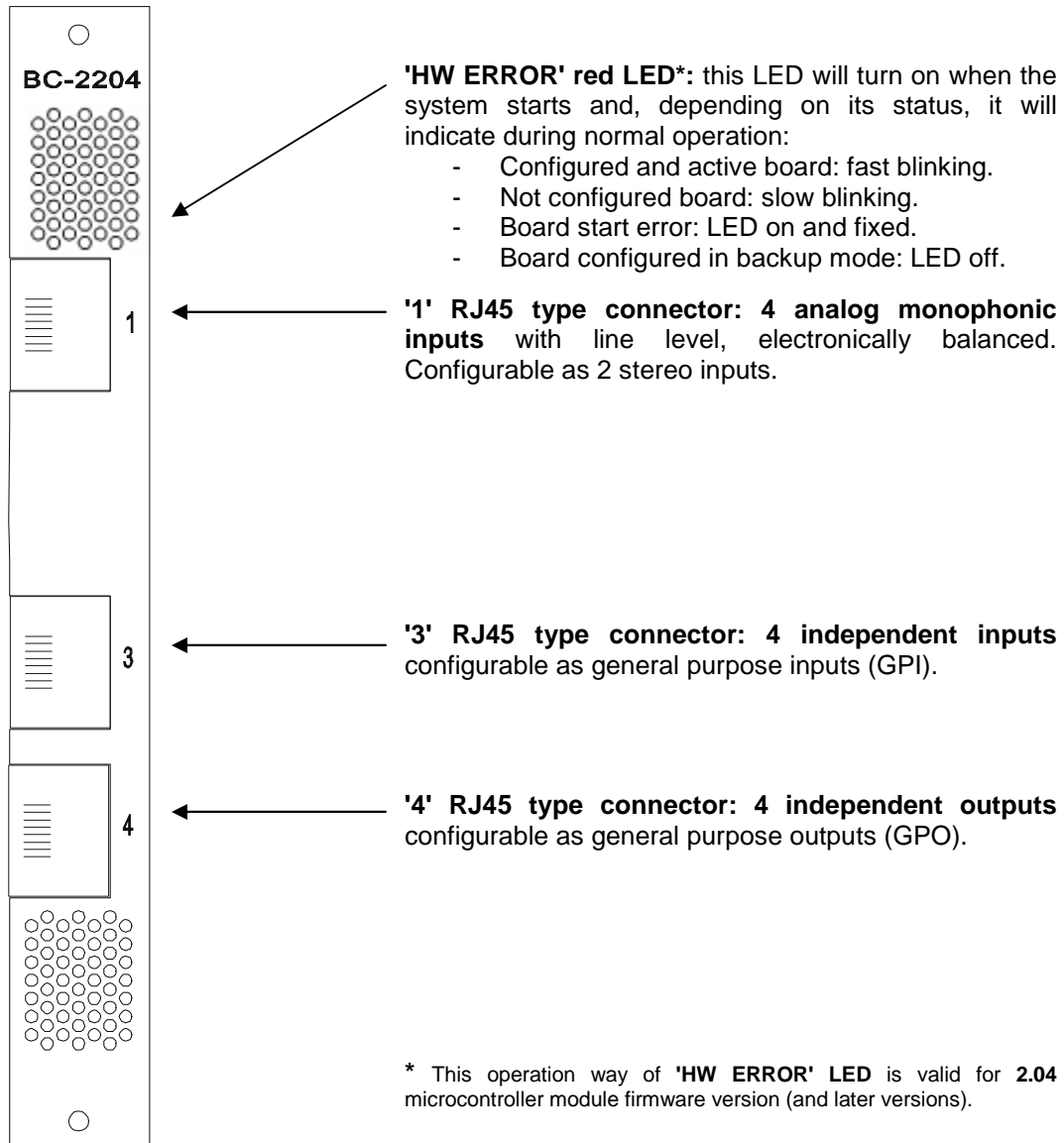

Other characteristics and features.

- Internal warning signal indicating a failure in one of the power supplies. If a failure occurs, the “ALARM” LED on the BC2240 controller board will light up.
- Power feed circuit designed to support hot-swapping operations.
- Digital adjustment of analog gain (± 12 dB) in the 4 inputs.
- Digital adjustment of digital gain (± 12 dB) in the 4 inputs.

Programming jumpers.

This board has a series of internal programming jumpers (PJ). However, these jumpers are configured at the factory and, in normal operation, do not need to be changed.

Firmware modules.

At the firmware level, this board is made up of the following modules:

- **PIC microcontroller:** manages board communications and start-up.
- **FPGA programmable device:** manages the converters and the TDM bus.

The firmware versions can be brought up to date by using the “**BC2000D Firmware Upgrade**” software application.

Signal layout in the RJ45 connectors of the board.

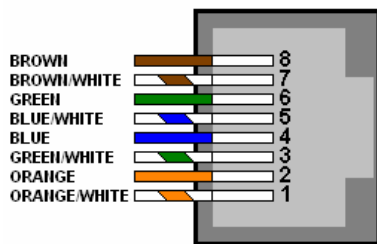

Pin	'1' Inputs	-	'3' GPI	'4' GPO
8	IN 2 (1R) V-	-	GND GPI2	GND GPO2
7	IN 2 (1R) V+	-	GPI2	GPO2
6	IN 3 (2L) V-	-	GND GPI3	GND GPO3
5	IN 4 (2R) V-	-	GND GPI4	GND GPO4
4	IN 4 (2R) V+	-	GPI4	GPO4
3	IN 3 (2L) V+	-	GPI3	GPO3
2	IN 1 (1L) V-	-	GND GPI1	GND GPO1
1	IN 1 (1L) V+	-	GPI1	GPO1
Chassis	AGND	-	AGND	AGND

NOTE: Pin layout corresponds to T568B standard.

BC2204 technical specifications.

This board has the same specifications as the BC2201 board, except for the characteristics relative to the analog outputs that are not implemented.

General characteristics.

- Approximate consumption: 9 watts.
- Approximate dimensions:
 Front: 17 x 172 mm.
 Depth: 255 mm.
- Approximate weight: 295 grams.

Characteristics are subject to change without notice.

3.8. BC2205. Analog line outputs module.

General description.

The BC2205 board can manage four TDM OUT bus time-slots to extract two analog stereo (or four mono) signals from the system with line level.

This board is inserted into the rear part of the BC2000DF rack.

Panel description.

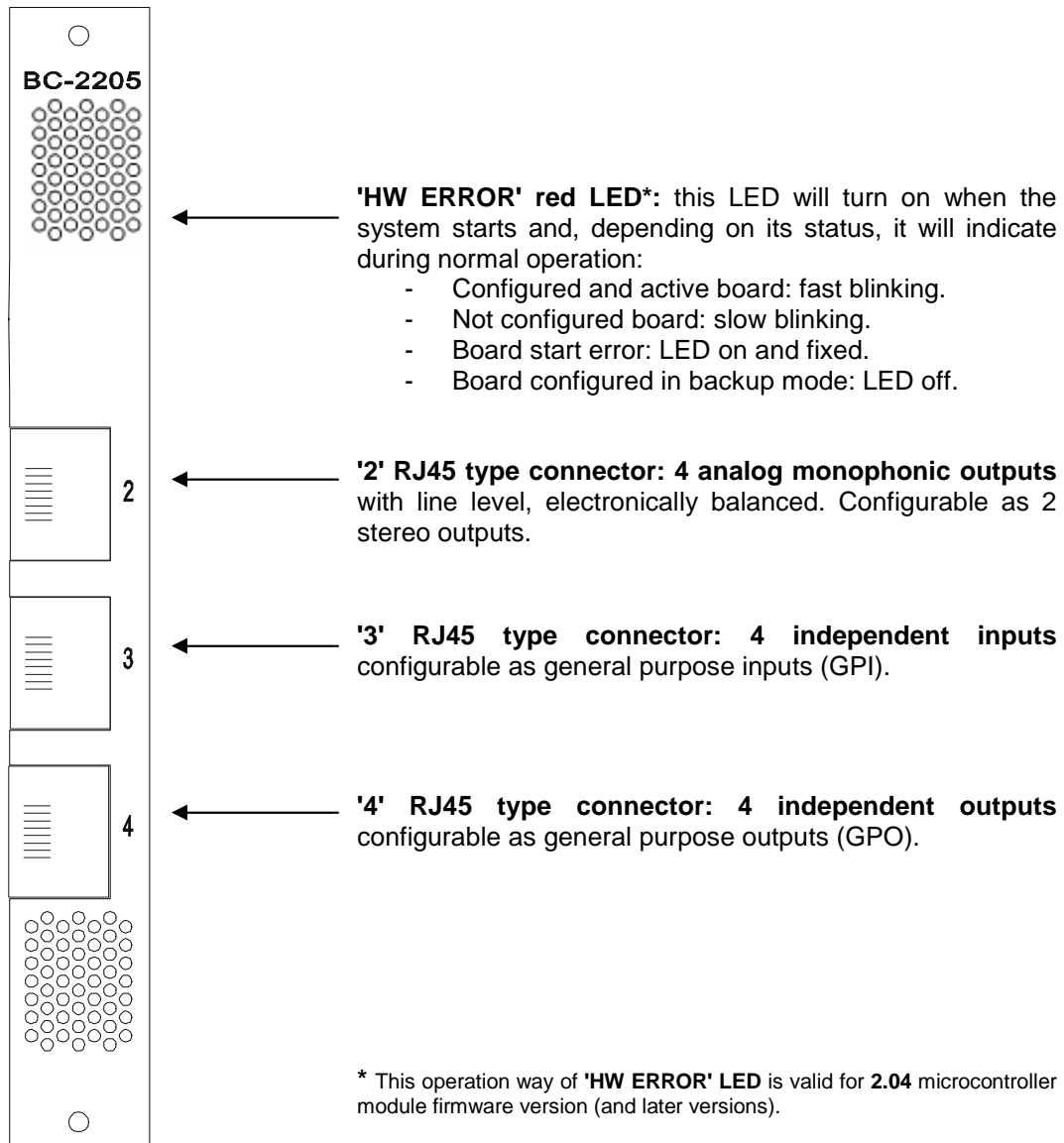

Other characteristics and features.

- Internal warning signal indicating a failure in one of the power supplies. If a failure occurs, the “ALARM” LED on the BC2240 controller board will light up.
- Power feed circuit designed to support hot-swapping operations.
- Digital adjustment of analog gain (± 12 dB) in the 4 outputs.
- Digital adjustment of digital gain (± 12 dB) in the 4 outputs.

Programming jumpers.

This board has a series of internal programming jumpers (PJ). However, these jumpers are configured at the factory and, in normal operation, do not need to be changed.

Firmware modules.

At the firmware level, this board is made up of the following modules:

- **PIC microcontroller:** manages board communications and start-up.
- **FPGA programmable device:** manages the converters and the TDM bus.

The firmware versions can be brought up to date by using the “**BC2000D Firmware Upgrade**” software application.

Signal layout in the RJ45 connectors of the board.

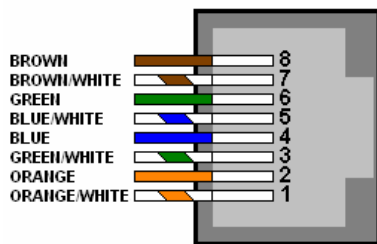

Pin	-	'2' Outputs	'3' GPI	'4' GPO
8	-	OUT 2 (1R) V-	GND GPI2	GND GPO2
7	-	OUT 2 (1R) V+	GPI2	GPO2
6	-	OUT 3 (2L) V-	GND GPI3	GND GPO3
5	-	OUT 4 (2R) V-	GND GPI4	GND GPO4
4	-	OUT 4 (2R) V+	GPI4	GPO4
3	-	OUT 3 (2L) V+	GPI3	GPO3
2	-	OUT 1 (1L) V-	GND GPI1	GND GPO1
1	-	OUT 1 (1L) V+	GPI1	GPO1
Chassis	-	AGND	AGND	AGND

NOTE: Pin layout corresponds to T568B standard.

BC2205 technical specifications.

This board has the same specifications as the BC2201, except for the characteristics relative to the analog inputs that are not implemented.

General characteristics.

- Approximate consumption: 9 watts.
- Approximate dimensions:
 - Front: 17 x 172 mm.
 - Depth: 255 mm.
- Approximate weight: 300 grams.

Characteristics are subject to change without notice.

3.9. BC2206. AES/EBU digital inputs module.

General description.

The BC2206 board can manage eight TDM IN bus time-slots to insert four AES3 (or SPDIF) digital stereo signals into the system.

This board is inserted into the rear part of the BC2000DF rack.

Panel description.

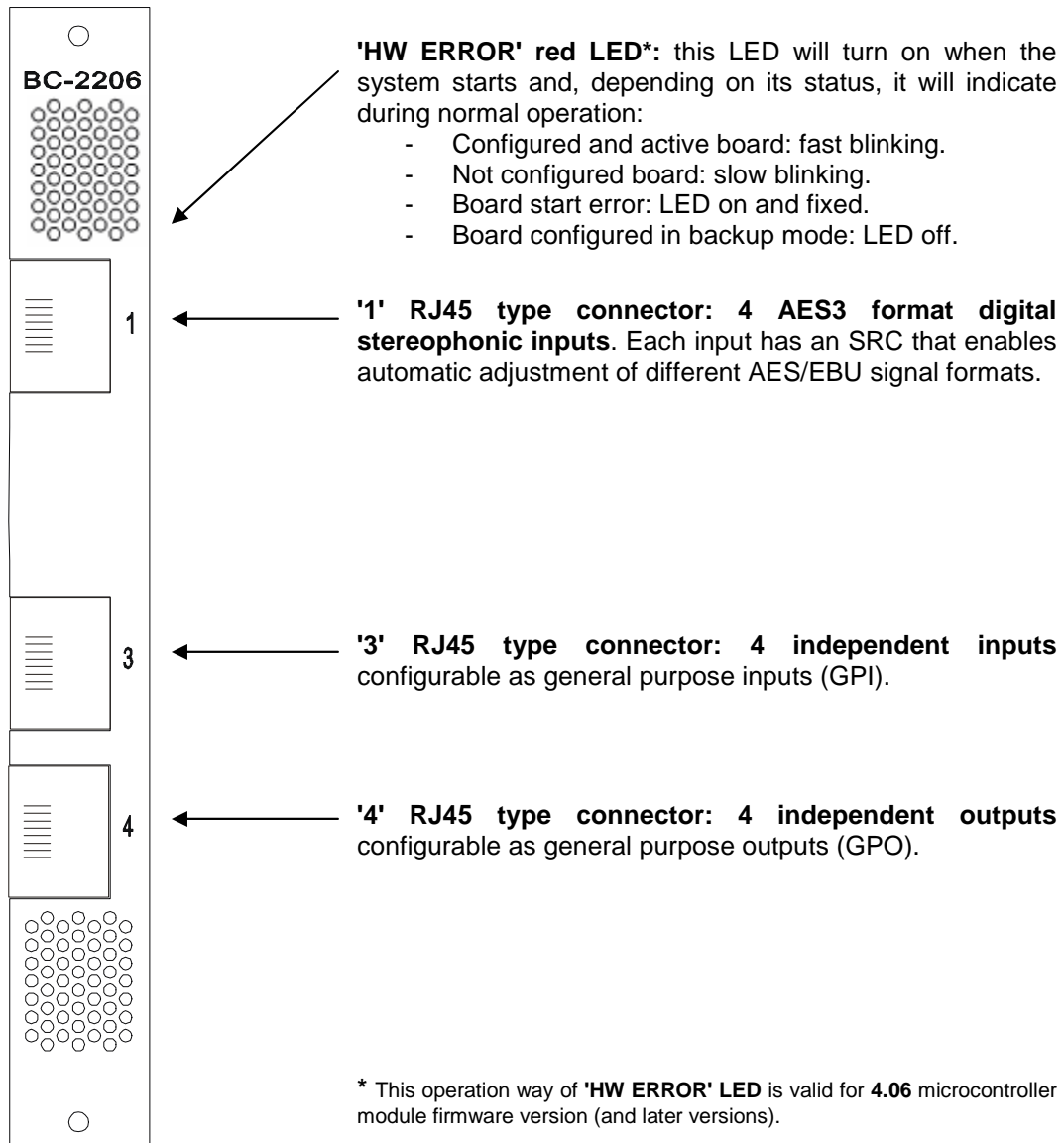

Other characteristics and features.

- Internal warning signal indicating a failure in one of the power supplies. If a failure occurs, the "ALARM" LED on the BC2240 controller board will light up.
- Power feed circuit designed to support hot-swapping operations.
- Digital adjustment of digital gain (± 12 dB) in the 4 inputs.
- Possibility of converting the module so that it can use SPDIF signals by manipulating the internal programming jumpers.

Programming jumpers.

This board is equipped with a series of internal programming jumpers (PJ) that allow you to change the format of the digital signal to be used between AES3 and SPDIF. You can independently change the format of each one of the four audio channels (circuit 0, 1, 2 and 3) by changing the following PJs:

CN12, CN13, CN16, CN18, CN22 → AES3 / SPDIF digital audio selectors, input circuit 0.

1-2: AES3 Digital Audio.

2-3: SPDIF Digital Audio.

CN24, CN31, CN32, CN33, CN38 → AES3 / SPDIF digital audio selectors, input circuit 1.

1-2: AES3 Digital Audio.

2-3: SPDIF Digital Audio.

CN14, CN15, CN19, CN21, CN26 → AES3 / SPDIF digital audio selectors, input circuit 2.

1-2: AES3 Digital Audio.

2-3: SPDIF Digital Audio.

CN28, CN35, CN36, CN37, CN41 → AES3 / SPDIF digital audio selectors, input circuit 3.

1-2: AES3 Digital Audio.

2-3: SPDIF Digital Audio.

The default position of these PJs is 1-2; that is, they are configured to work with digital audio in AES/EBU format.

Firmware modules.

At the firmware level, this board is made up of the following modules:

- **PIC microcontroller:** manages board communications and start-up.
- **FPGA programmable device:** manages SRCs and the TDM bus.

The firmware versions can be brought up to date by using the "BC2000D Firmware Upgrade" software application.

Signal layout in the RJ45 connectors of the board.

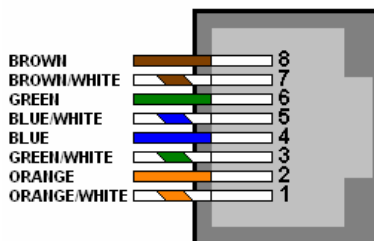

Pin	'1' Inputs	-	'3' GPI	'4' GPO
8	IN 2 (1R) N	-	GND GPI2	GND GPO2
7	IN 2 (1R) P	-	GPI2	GPO2
6	IN 3 (2L) N	-	GND GPI3	GND GPO3
5	IN 4 (2R) N	-	GND GPI4	GND GPO4
4	IN 4 (2R) P	-	GPI4	GPO4
3	IN 3 (2L) P	-	GPI3	GPO3
2	IN 1 (1L) N	-	GND GPI1	GND GPO1
1	IN 1 (1L) P	-	GPI1	GPO1
Chassis	GND	-	GND	GND

NOTE: Pin layout corresponds to T568B standard.

BC2206 technical specifications.

This board has the same specifications as the BC2202 board, except for the characteristics relative to the digital outputs.

General characteristics.

- Approximate consumption: 4 watts.
- Approximate dimensions:
 - Front: 17 x 172 mm.
 - Depth: 255 mm.
- Approximate weight: 280 grams.

Characteristics are subject to change without notice.

3.10. BC2207. AES/EBU digital outputs module.

General description.

The BC2207 board can manage eight TDM OUT bus time-slots to extract four AES3 (or SPDIF) digital stereo signals from the system.

This board is inserted into the rear part of the BC2000DF rack.

Panel description.

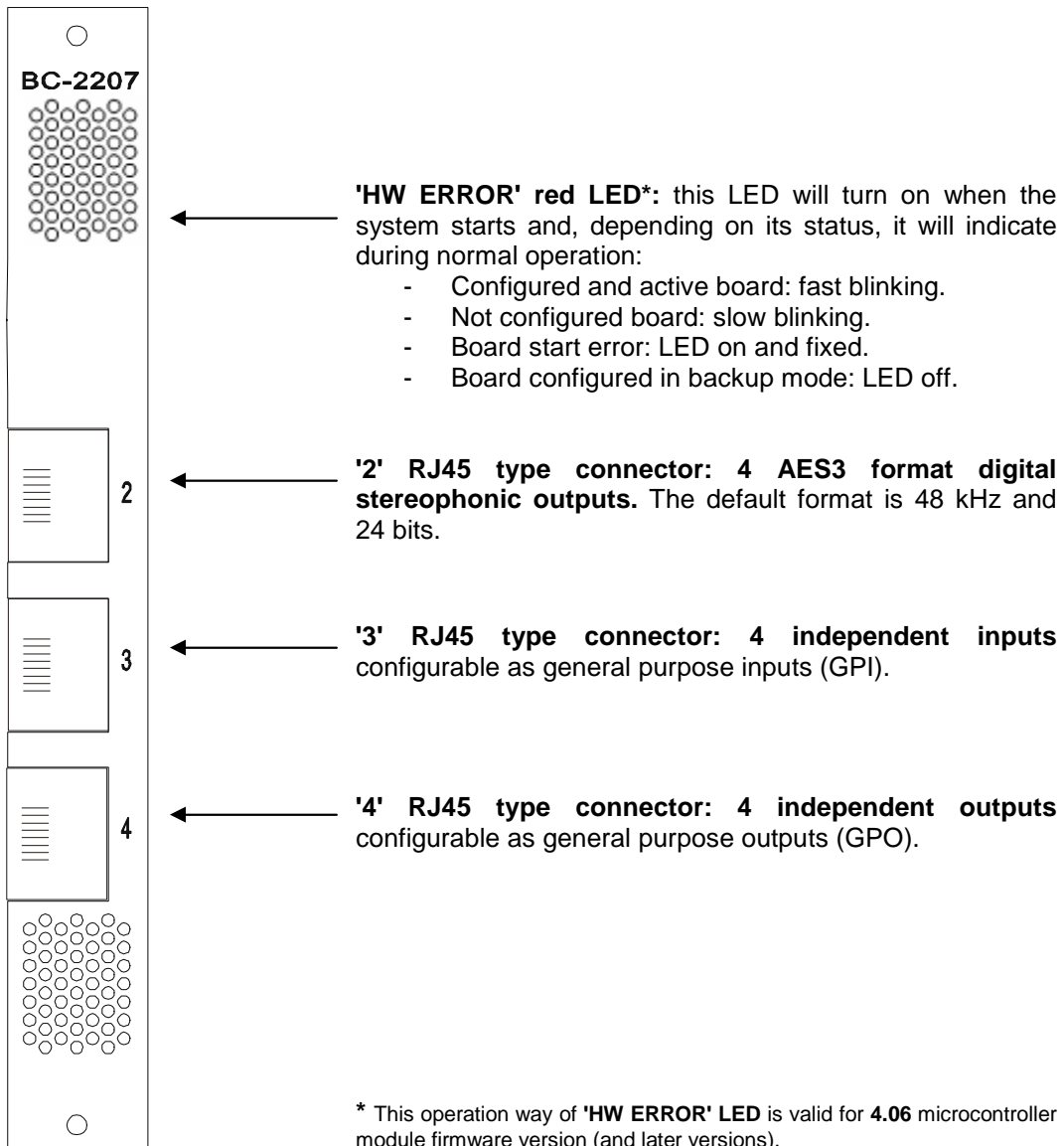

Other characteristics and features.

- Internal warning signal indicating a failure in one of the power supplies. If a failure occurs, the “ALARM” LED on the BC2240 controller board will light up.
- Power feed circuit designed to support hot-swapping operations.
- Digital adjustment of digital gain (± 12 dB) in the 4 outputs.
- Possibility of converting the module so that it can use SPDIF signals by manipulating the internal programming jumpers.

Programming jumpers.

This board is equipped with a series of internal programming jumpers (PJ) that allow you to change the format of the digital signal to be used between AES3 and SPDIF. You can independently change the format of each one of the four audio channels (circuit 0, 1, 2 and 3) by changing the following PJs:

CN17, CN23, CN25, CN55 → AES3 / SPDIF digital audio selectors for output circuit 0.

- 1-2: AES3 Digital Audio.
- 2-3: SPDIF Digital Audio.

CN30, CN39, CN40, CN56 → AES3 / SPDIF digital audio selectors for output circuit 1.

- 1-2: AES3 Digital Audio.
- 2-3: SPDIF Digital Audio.

CN20, CN27, CN29, CN57 → AES3 / SPDIF digital audio selectors for output circuit 2.

- 1-2: AES3 Digital Audio.
- 2-3: SPDIF Digital Audio.

CN34, CN42, CN43, CN58 → AES3 / SPDIF digital audio selectors for output circuit 3.

- 1-2: AES3 Digital Audio.
- 2-3: SPDIF Digital Audio.

The default position of these PJs is 1-2; that is, they are configured to work with digital audio in AES/EBU format.

Firmware modules.

At the firmware level, this board is made up of the following modules:

- **PIC microcontroller:** manages board communications and start-up.
- **FPGA programmable device:** manages SRCs and the TDM bus.

The firmware versions can be brought up to date by using the “**BC2000D Firmware Upgrade**” software application.

Signal layout in the RJ45 connectors of the board.

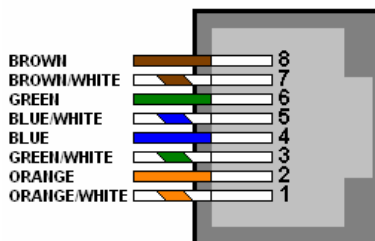

Pin	-	'2' Outputs	'3' GPI	'4' GPO
8	-	OUT 2 (1R) N	GND GPI2	GND GPO2
7	-	OUT 2 (1R) P	GPI2	GPO2
6	-	OUT 3 (2L) N	GND GPI3	GND GPO3
5	-	OUT 4 (2R) N	GND GPI4	GND GPO4
4	-	OUT 4 (2R) P	GPI4	GPO4
3	-	OUT 3 (2L) P	GPI3	GPO3
2	-	OUT 1 (1L) N	GND GPI1	GND GPO1
1	-	OUT 1 (1L) P	GPI1	GPO1
Chassis	-	GND	GND	GND

NOTE: Pin layout corresponds to T568B standard.

BC2207 technical specifications.

This board has the same specifications as the BC2202 board, except for the characteristics relative to the digital inputs.

General characteristics.

- Approximate consumption: 4 watts.
- Approximate dimensions:
 - Front: 17 x 172 mm.
 - Depth: 255 mm.
- Approximate weight: 280 grams.

Characteristics are subject to change without notice.

3.11. BC2208. Analog line inputs/outputs module with transformer balanced inputs.

General description.

The BC2208 board can manage four TDM IN bus time-slots to insert two analog stereo (or four mono) signals into the system with line level, and four TDM OUT bus time-slots to extract two analog stereo (or four mono) signals from the system with line level. The inputs are transformer balanced.

This board is inserted into the rear part of the BC2000DF rack.

Panel description.

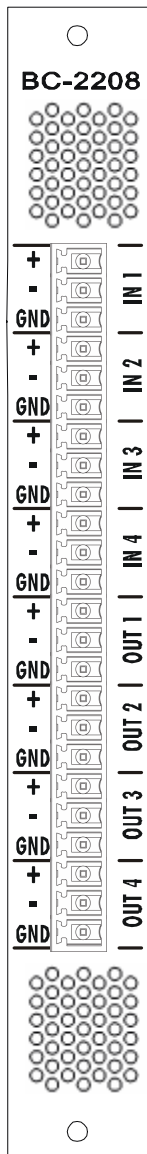

'HW ERROR' red LED: this LED will turn on when the system starts and, depending on its status, it will indicate during normal operation:

- Configured and active board: fast blinking.
- Not configured board: slow blinking.
- Board start error: LED on and fixed.
- Board configured in backup mode: LED off.

Multipin connectors: 4 analog monophonic inputs with line level, transformer balanced. Configurable as 2 stereo inputs.

Multipin connectors: 4 analog monophonic outputs with line level, electronically balanced. Configurable as 2 stereo outputs.

Other characteristics and features.

- Internal warning signal indicating a failure in one of the power supplies. If a failure occurs, the “ALARM” LED on the BC2240 controller board will light up.
- Power feed circuit designed to support hot-swapping operations.
- Digital adjustment of digital gain (± 12 dB) in the 4 inputs and the 4 outputs.

Programming jumpers.

This board has a series of internal programming jumpers (PJ). However, these jumpers are configured at the factory and, in normal operation, do not need to be changed.

Firmware modules.

At the firmware level, this board is made up of the following modules:

- **PIC microcontroller:** manages board communications and start-up.
- **FPGA programmable device:** manages the converters and the TDM bus.

The firmware versions can be brought up to date by using the “**BC2000D Firmware Upgrade**” software application.

BC2208 technical specifications.

Analog inputs:

- 24-bit, 48 kHz A/D converters.
- Nominal input level: +4 dBu (software configurable).
- Maximum input level: +22 dBu.
- Minimum input level: -8 dBu.

Analog outputs:

- 24-bit, 48 kHz D/A converters.
- Nominal output level: +4 dBu.
- Maximum output level: +22 dBu.

General audio specifications:

- Bandwidth: 20 to 20,000Hz ± 0.5 dB.
- Distortion: less than 0.08% between 40 and 20000Hz (less than 0.2% in the bandwidth).
- Input + output noise level (in audio frequencies): -85 dBu.
- Cross-talk: less than -100dB in the bandwidth.

General characteristics.

- Approximate consumption: 6 watts.
- Approximate dimensions:
 - Front: 17 x 172 mm.
 - Depth: 255 mm.
- Approximate weight: 342 grams.

Characteristics are subject to change without notice.

3.12. BC2208XF. Analog line inputs/outputs module with transformer balanced inputs/outputs.

General description.

The BC2208XF board can manage four TDM IN bus time-slots to insert two analog stereo (or four mono) signals into the system with line level, and four TDM OUT bus time-slots to extract two analog stereo (or four mono) signals from the system with line level. The inputs as well as the outputs are transformer balanced.

This board is inserted into the rear part of the BC2000DF rack.

Panel description.

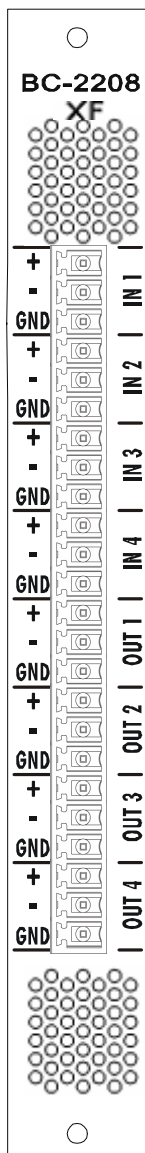

'HW ERROR' red LED: this LED will turn on when the system starts and, depending on its status, it will indicate during normal operation:

- Configured and active board: fast blinking.
- Not configured board: slow blinking.
- Board start error: LED on and fixed.
- Board configured in backup mode: LED off.

Multipin connectors: 4 analog monophonic inputs with line level, transformer balanced. Configurable as 2 stereo inputs.

Multipin connectors: 4 analog monophonic outputs with line level, transformer balanced. Configurable as 2 stereo outputs.

Other characteristics and features.

- Internal warning signal indicating a failure in one of the power supplies. If a failure occurs, the “ALARM” LED on the BC2240 controller board will light up.
- Power feed circuit designed to support hot-swapping operations.
- Digital adjustment of digital gain (± 12 dB) in the 4 inputs and the 4 outputs.

Programming jumpers.

This board has a series of internal programming jumpers (PJ). However, these jumpers are configured at the factory and, in normal operation, do not need to be changed.

Firmware modules.

At the firmware level, this board is made up of the following modules:

- **PIC microcontroller:** manages board communications and start-up.
- **FPGA programmable device:** manages the converters and the TDM bus.

The firmware versions can be brought up to date by using the “**BC2000D Firmware Upgrade**” software application.

BC2208XF technical specifications.

Analog inputs:

- 24-bit, 48 kHz A/D converters.
- Nominal input level: +4 dBu (software configurable).
- Maximum input level: +22 dBu.
- Minimum input level: -8 dBu.

Analog outputs:

- 24-bit, 48 kHz D/A converters.
- Nominal output level: +4 dBu.
- Maximum output level: +18 dBu.

General audio specifications:

- Bandwidth (inputs): 20 to 20,000Hz ± 0.8 dB (40 to 20,000Hz ± 0.5 dB).
- Bandwidth (outputs): 20 to 20,000Hz ± 0.3 dB.
- Distortion (inputs): less than 0.05% between 40 and 20,000Hz (less than 0.15% in the bandwidth).
- Distortion (outputs): less than 0.02% between 20 and 20,000Hz.

General characteristics.

- Approximate consumption: 6 watts.
- Approximate dimensions:
 - Front: 17 x 172 mm.
 - Depth: 255 mm.
- Approximate weight: 342 grams.

Characteristics are subject to change without notice.

3.13. BC2209. 8 Analog line inputs/outputs module.

General description.

The BC2209 board can manage eight TDM IN bus time-slots to insert four analog stereo (or eight mono) signals into the system with line level, and eight TDM OUT bus time-slots to extract four analog stereo (or eight mono) signals from the system with line level.

This board is inserted into the rear part of the BC2000DF rack.

Panel description.

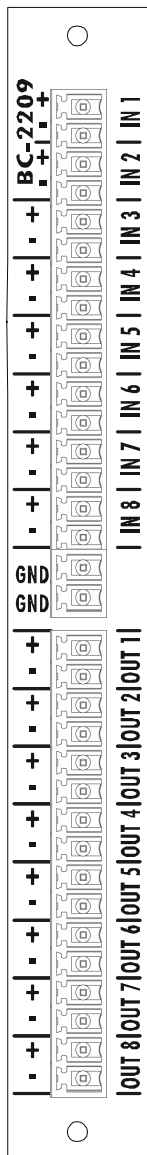

'HW ERROR' red LED: this LED will turn on when the system starts and, depending on its status, it will indicate during normal operation:

- Configured and active board: fast blinking.
- Not configured board: slow blinking.
- Board start error: LED on and fixed.
- Board configured in backup mode: LED off.

Multipin connectors: 8 analog monophonic inputs with line level, electronically balanced. Configurable as 4 stereo inputs.

Multipin connector: common ground connector for inputs and outputs.

Multipin connectors: 8 analog monophonic outputs with line level, electronically balanced. Configurable as 4 stereo outputs.

Other characteristics and features.

- Internal warning signal indicating a failure in one of the power supplies. If a failure occurs, the “ALARM” LED on the BC2240 controller board will light up.
- Power feed circuit designed to support hot-swapping operations.
- Digital adjustment of digital gain (± 12 dB) in the 8 inputs and the 8 outputs.

Programming jumpers.

This board has a series of internal programming jumpers (PJ). However, these jumpers are configured at the factory and, in normal operation, do not need to be changed.

Firmware modules.

At the firmware level, this board is made up of the following modules:

- **PIC microcontroller:** manages board communications and start-up.
- **FPGA programmable device:** manages the converters and the TDM bus.

The firmware versions can be brought up to date by using the “**BC2000D Firmware Upgrade**” software application.

BC2209 technical specifications.

Analog inputs:

- 24-bit, 48 kHz A/D converters.
- Nominal input level: +4 dBu (software configurable).
- Maximum input level: +22 dBu.
- Minimum input level: -8 dBu.

Analog outputs:

- 24-bit, 48 kHz D/A converters.
- Nominal output level: +4 dBu.
- Maximum output level: +22 dBu.

General audio specifications:

- Bandwidth: 20 to 20,000Hz ± 0.5 dB.
- Distortion: less than 0.03% in the bandwidth.
- Input + output noise level (in audio frequencies): -84 dBu.
- Cross-talk: less than -90 dB in the bandwidth.

General characteristics.

- Approximate consumption: 8 watts.
- Approximate dimensions:
 - Front: 17 x 172 mm.
 - Depth: 255 mm.
- Approximate weight: 299 grams.

Characteristics are subject to change without notice.

3.14. BC2210. Intercom Panels Interfaces module.

General description.

The BC2210 board can manage the connection of up to 8 Digital Intercom Panels. This board is inserted into the rear part of the BC2000DF rack.

Panel description.



Other characteristics and features.

- Internal warning signal indicating a failure in one of the power supplies. If a failure occurs, the “ALARM” LED on the BC2240 controller board will light up.
- Power feed circuit designed to support hot-swapping operations.

Programming jumpers.

This board has a series of internal programming jumpers (PJ). However, these jumpers are configured at the factory and, in normal operation, do not need to be changed.

Firmware modules.

At the firmware level, this board is made up of the following modules:

- **PIC microcontroller:** manages board communications and start-up.
- **FPGA programmable device:** manages the TDM bus.

The firmware versions can be brought up to date by using the “**BC2000D Firmware Upgrade**” software application.

Signal layout in the RJ45 connectors of the board.

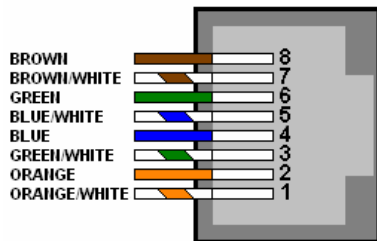

Pin	'1'	'2'	'3'	'4'	'5'	'6'	'7'	'8'
8	-	-	-	-	-	-	-	-
7	-	-	-	-	-	-	-	-
6	TX-	TX-	TX-	TX-	TX-	TX-	TX-	TX-
5	RX-	RX-	RX-	RX-	RX-	RX-	RX-	RX-
4	RX+	RX+	RX+	RX+	RX+	RX+	RX+	RX+
3	TX+	TX+	TX+	TX+	TX+	TX+	TX+	TX+
2	-	-	-	-	-	-	-	-
1	-	-	-	-	-	-	-	-
Chassis								

NOTE: Pin layout corresponds to T568B standard.

BC2210 technical specifications.

It has 8 connections ports for specific Digital Intercom panels.

General characteristics.

- Approximate consumption: 10 watts.
- Approximate dimensions:
 - Front: 17 x 172 mm.
 - Depth: 255 mm.
- Approximate weight: 400 grams.

Characteristics are subject to change without notice.

3.15. BC2211. AES 10 MAD I module for linking racks.

General description.

The BC2211 board manages 56 or 64 TDM bus time-slots to send and/or receive them through a 125-Mbps MAD I multichannel digital audio link using coaxial or optical fiber cable. This board allows you to interconnect two BC 2000 D racks, or to connect any other MAD I equipment item. It is compliant with the AES-10 standard.

You can install two modules with the same link for redundancy purposes.

This board is inserted into the rear part of the BC2000DF rack.

Panel description.

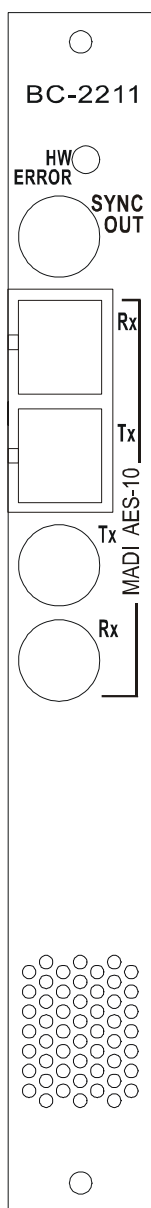

'HW ERROR' red LED*: this LED will turn on when the system starts and, depending on its status, it will indicate during normal operation:

- Configured and active board: fast blinking.
- Not configured board: slow blinking.
- Board start error: LED on and fixed.
- Board configured in backup mode: LED off.

1.6-5.6 'SYNC OUT' female coaxial connector: word-clock synchronism output with TTL level.

SC 'Rx' and 'Tx' connectors: FDDI PMD optical fiber interface with a range of 2000 meters (if your installation entails a range greater than 2000 meters, contact our sales department).

1.6-5.6 female 'Rx' and 'Tx' coaxial connectors: 75-ohm coaxial cable interface with a range of 50 meters.

* This operation way of **'HW ERROR' LED** is valid for **1.42** microcontroller module firmware version (and later versions).

Other characteristics and features.

- Internal warning signal indicating a failure in one of the power supplies. If a failure occurs, the "ALARM" LED on the BC2240 controller board will light up.
- Power feed circuit designed to support hot-swapping operations.

Programming jumpers.

This board has a series of internal programming jumpers (PJ). However, these jumpers are configured at the factory and, in normal operation, do not need to be changed.

Firmware modules.

At the firmware level, this board is made up of the following modules:

- **PIC microcontroller:** manages board communications and start-up.
- **FPGA programmable device:** manages the TDM bus.

The firmware versions can be brought up to date by using the "BC2000D Firmware Upgrade" software application.

BC2211 technical specifications.

Synchronism output:

- Type: TTL (Word-Clock).
- Connector: 1.6-5.6 female coaxial.

Coaxial interface:

- Type: 75 Ω coaxial.
- Nominal range: 50 m.
- Connectors: 1.6-5.6 female.
- Type of cable: 75 $\Omega \pm 2 \Omega$ coaxial, attenuation less than 0.1 dB/m.

Optical fiber interface:

- Type: FDDI PMD.
- Nominal range: 2,000 meters (if your installation entails a range greater than 2000 meters, contact our sales department).
- Type of fiber: 62.5 / 125 μm MULTIMODE.
- Transmission: LED, 1300 nm.

General characteristics.

- Approximate consumption: 8.5 watts.
- Approximate dimensions:
 - Front: 17 x 172 mm.
 - Depth: 255 mm.
- Approximate weight: 310 grams.

Characteristics are subject to change without notice.

3.16. BC2212. Dual AES 10 MADI module for linking racks.

General description.

The BC2212 board has twice the capacity of the BC 2211 board. The BC 2212 manages up to 128 TDM bus time-slots to send and/or receive them through two 125-Mbps MADI multichannel digital audio links using coaxial or optical fiber cable. These two MADI links are independent. This board allows you to interconnect up to three BC 2000 D racks (you can use each of the two MADI links to connect to other 2 BC2211 or BC2212 boards placed in different racks), or to connect any other MADI equipment item. It is compliant with the AES-10 standard.

You can install two modules with the same link for redundancy purposes or you can use both links of the board redundantly (link 2 acts as a backup for link 1).

This board is inserted into the rear part of the BC2000DF rack.

Panel description.

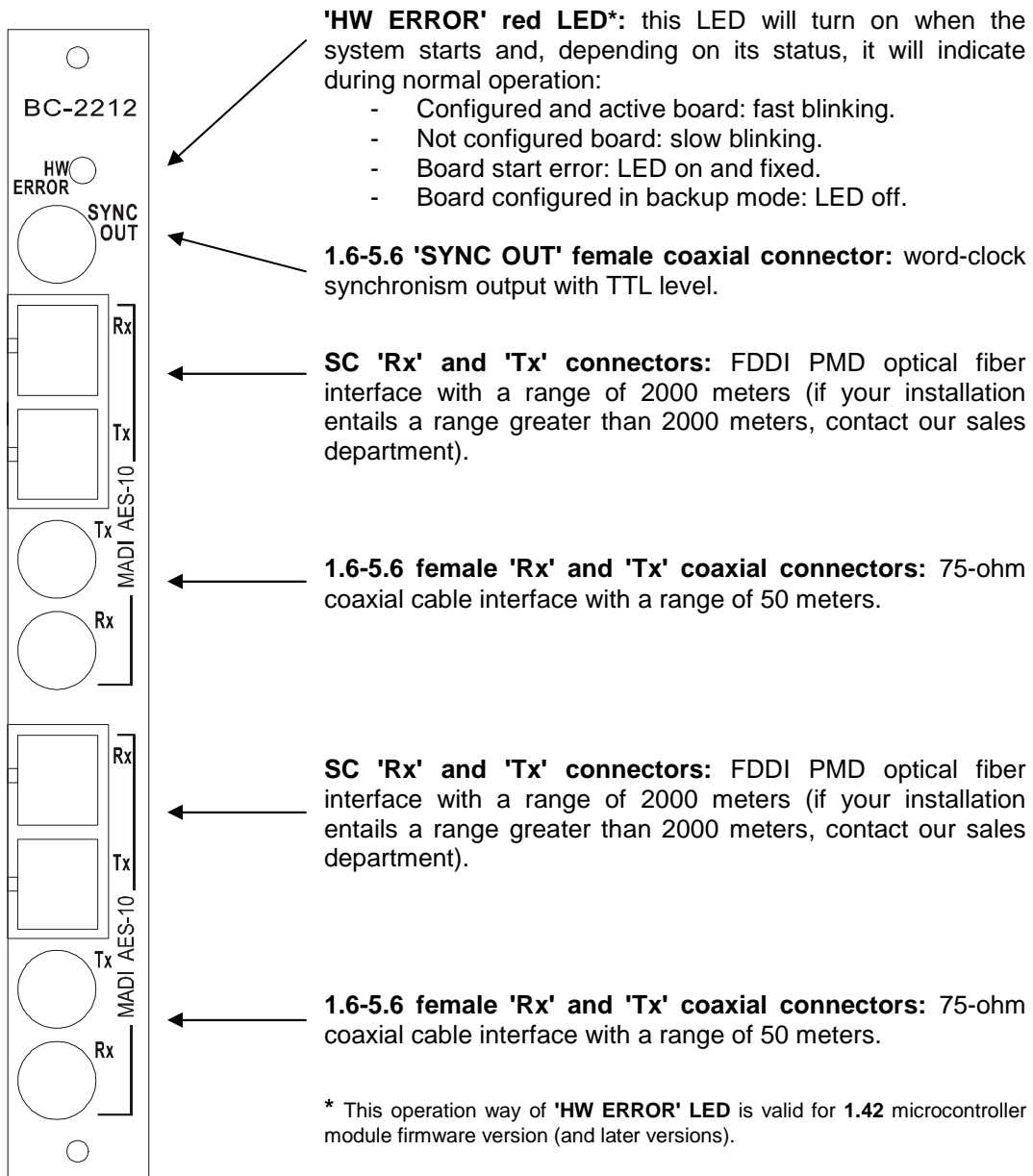

Other characteristics and features.

- Internal warning signal indicating a failure in one of the power supplies. If a failure occurs, the "ALARM" LED on the BC2240 controller board will light up.
- Power feed circuit designed to support hot-swapping operations.

Programming jumpers.

This board has a series of internal programming jumpers (PJ). However, these jumpers are configured at the factory and, in normal operation, do not need to be changed.

Firmware modules.

At the firmware level, this board is made up of the following modules:

- **PIC microcontroller:** manages board communications and start-up.
- **FPGA programmable device:** manages the TDM bus.

The firmware versions can be brought up to date by using the "BC2000D Firmware Upgrade" software application.

BC2212 technical specifications.

Synchronism output:

- Type: TTL (Word-Clock).
- Connector: 1.6-5.6 female coaxial.

Coaxial interface:

- Type: 75Ω coaxial.
- Nominal range: 50 m.
- Connectors: 1.6-5.6 female.
- Type of cable: 75Ω ±2Ω coaxial, attenuation less than 0.1 dB/m.

Optical fiber interface:

- Type: FDDI PMD.
- Nominal range: 2,000 meters (if your installation entails a range greater than 2000 meters, contact our sales department).
- Type of fiber: 62.5 / 125 μm MULTIMODE.
- Transmission: LED, 1300 nm.

General characteristics.

- Approximate consumption: 10.5 watts.
- Approximate dimensions:
 - Front: 17 x 172 mm.
 - Depth: 255 mm.
- Approximate weight: 335 grams.

Characteristics are subject to change without notice.

3.17. BC2312. Dual AES 10 MADI module for linking racks with SFP transceivers.

General description.

The BC2312 board manages up to 128 TDM bus time-slots to send and/or receive them through two 125-Mbps MADI multichannel digital audio links using coaxial or optical fiber cable (through SFP - Small Form Pluggable transceivers). These two MADI links are independent. This board allows you to interconnect up to three BC 2000 D racks (you can use each of the two MADI links to connect to other 2 BC2312 boards placed in different racks), or to connect any other MADI equipment item. It is compliant with the AES-10 standard.

You can install two modules with the same link for redundancy purposes or you can use both links of the board redundantly (link 2 acts as a backup for link 1).

This board is inserted into the rear part of the BC2000DF rack.

Panel description.

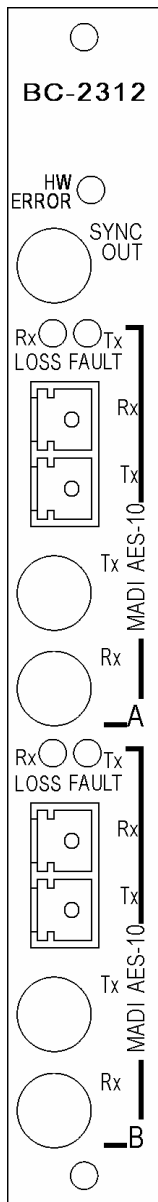

'HW ERROR' red LED: this LED will turn on when the system starts and, depending on its status, it will indicate during normal operation:

- Configured and active board: fast blinking.
- Configured and active board extracting synchronism: discontinuous fast blinking.
- Not configured board: slow blinking.
- Board start error: LED on and fixed.
- Board configured in backup mode: LED off.
- Board configured in backup mode extracting synchronism: LED off with discontinuous on status.

1.6-5.6 'SYNC OUT' female coaxial connector: word-clock synchronism output with TTL level.

'Rx LOSS' red LED: indicates an alarm in the optical fiber receiver because no reception signal is detected.

'Tx FAULT' red LED: indicates an alarm in the optical fiber transmitter.

LC 'Rx' and 'Tx' connectors*: SFP (Small Form Pluggable) optical fiber transceiver, removable and interchangeable without tools.

1.6-5.6 female 'Rx' and 'Tx' coaxial connectors: 75-ohm coaxial cable interface with a range of 50 meters.

'Rx LOSS' red LED: indicates an alarm in the optical fiber receiver because no reception signal is detected.

'Tx FAULT' red LED: indicates an alarm in the optical fiber transmitter.

LC 'Rx' and 'Tx' connectors*: SFP (Small Form Pluggable) optical fiber transceiver, removable and interchangeable without tools.

1.6-5.6 female 'Rx' and 'Tx' coaxial connectors: 75-ohm coaxial cable interface with a range of 50 meters.

*It's possible to use any 125Mbps OF **SFP transceiver** monomode or multimode. The maximum range that can be reached is 2Km for MULTIMODE fiber and more than 150Km for MONOMODE fiber.

Other characteristics and features.

- Internal warning signal indicating a failure in one of the power supplies. If a failure occurs, the "ALARM" LED on the BC2240 controller board will light up.
- Power feed circuit designed to support hot-swapping operations.

Programming jumpers.

This board has a series of internal programming jumpers (PJ). However, these jumpers are configured at the factory and, in normal operation, do not need to be changed.

Firmware modules.

At the firmware level, this board is made up of the following modules:

- **PIC microcontroller:** manages board communications and start-up.
- **FPGA programmable device:** manages the TDM bus.

The firmware versions can be brought up to date by using the "BC2000D Firmware Upgrade" software application.

BC2312 technical specifications.

Synchronism output:

- Type: TTL (Word-Clock).
- Connector: 1.6-5.6 female coaxial.

Coaxial interface:

- Type: 75 Ω coaxial.
- Nominal range: 50 m.
- Connectors: 1.6-5.6 female.
- Type of cable: 75 Ω \pm 2 Ω coaxial, attenuation less than 0.1 dB/m.

Optical fiber interface:

- Type: SFP (Small Form Pluggable). Package style duplex LC.
- Nominal range (depending on transceiver used):
 - 2000 meters for 62.5/125 μ m MULTIMODE fiber.
 - >150 Km for 9/125 μ m MONOMODE fiber.

General characteristics.

- Approximate consumption: 10 watts.
- Approximate dimensions:
 - Front: 17 x 172 mm.
 - Depth: 255 mm.
- Approximate weight: 333 grams (including transceivers).

Characteristics are subject to change without notice.

3.18. BC2213. Digital audio transmission module through high speed optical fiber link.

General description.

The BC2213 board manages up to 1024 TDM bus time-slots to send and/or receive them through a multichannel digital audio link using optical fiber with a transmission speed of 1.96Gbps.

This board allows you to interconnect two BC 2000 D racks with up to 16 MADI circuits each one (16 x 64 = 1024 audio channels). You can also interconnect several 1024 audio channels BC2000D subsystems with AEQ HSCS matrix in order to create systems of up to 5120 x 5120 circuits.

This board is inserted into the rear part of the BC2000DF rack.

Descripción del panel.

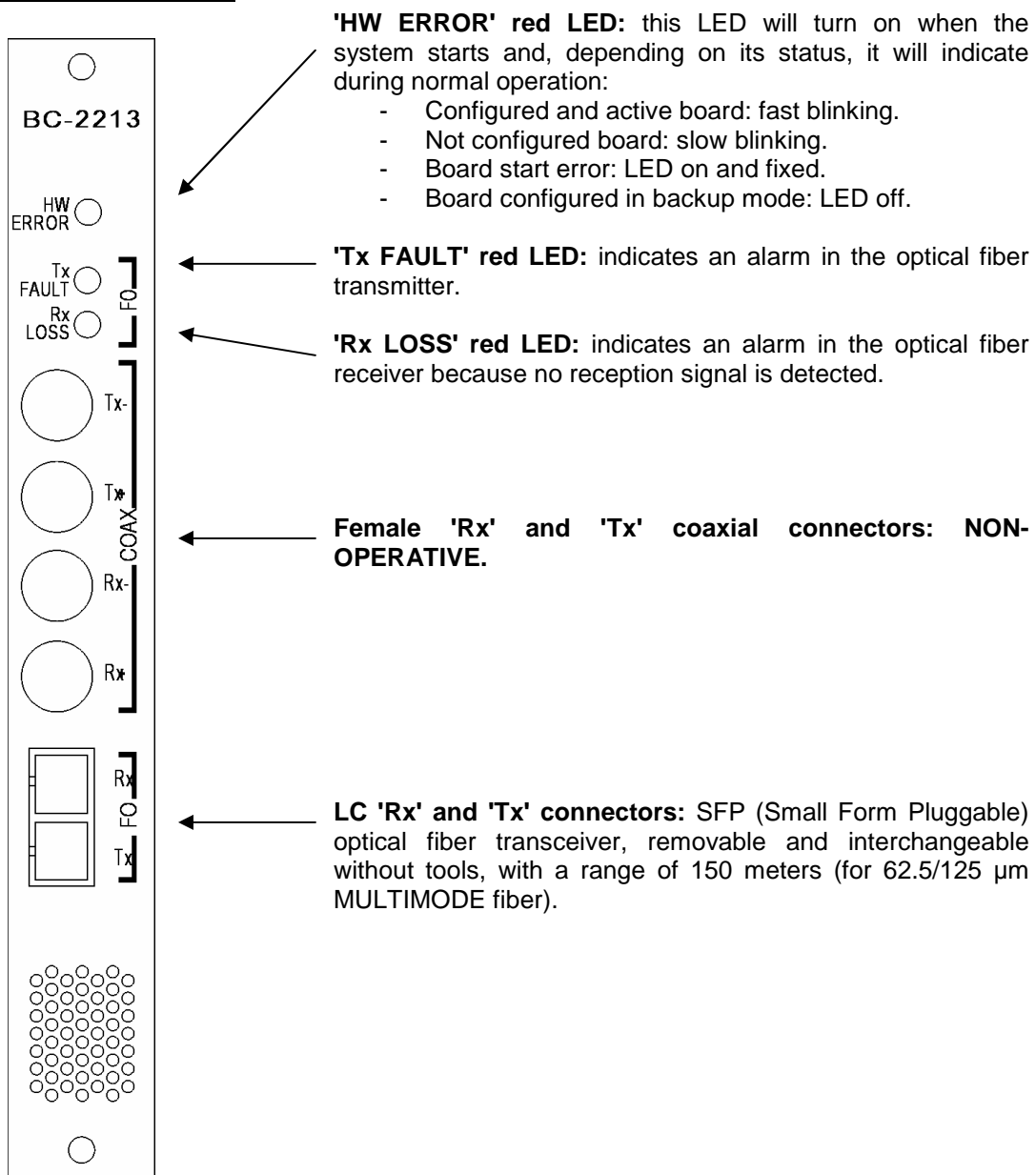

Other characteristics and features.

- Internal warning signal indicating a failure in one of the power supplies. If a failure occurs, the "ALARM" LED on the BC2240 controller board will light up.
- Power feed circuit designed to support hot-swapping operations.

Programming jumpers.

This board has a series of internal programming jumpers (PJ). However, these jumpers are configured at the factory and, in normal operation, do not need to be changed.

Firmware modules.

At the firmware level, this board is made up of the following modules:

- **PIC microcontroller:** manages board communications, as well as board configuration, alarms and status.
- **FPGA programmable device:** manages the TDM bus. Two 2Gbps full duplex SerDes (Serializer / Deserializer) are integrated.

The firmware versions can be brought up to date by using the "**BC2000D Firmware Upgrade**" software application.

BC2213 technical specifications.

Coaxial interface: NON-OPERATIVE.

Optical fiber interface:

- Type: SFP (Small Form Pluggable). Package style duplex LC.
- Nominal range: 150 meters (300 meters for 50/125 μ m MULTIMODE fiber).
- Type of fiber: 62.5/125 μ m MULTIMODE.
- Transmission: LED, 850 nm.

General characteristics.

- Approximate consumption: 5 watts.
- Approximate dimensions:
 - Front: 17 x 172 mm.
 - Depth: 255 mm.
- Approximate weight: 322 grams.

Characteristics are subject to change without notice.

3.19. BC2214 and BC2224. Multi-channel audio over IP module with Dante protocol of 32 channels (BC2214) or 64 channels (BC2224).

General description.

The BC2214 board manages up to 32 TDM bus time-slots to send and/or receive them through a bidirectional multi-channel link of 32 audio channels over IP with Dante technology.

The BC2224 board has twice the capacity of the BC2214 board, it manages up to 64 TDM bus time-slots and 64 AoIP Dante audio channels.

This board is inserted into the rear part of the BC2000DF rack.

Panel description.

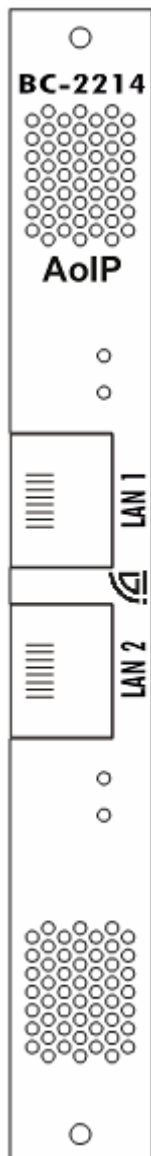

'HW ERROR' red LED: this LED will turn on when the system starts and, depending on its status, it will indicate during normal operation:

- Configured and active board: fast blinking.
- Configured and active board extracting synchronization from IP link: fast blinking with momentary interruptions.
- Not configured board: slow blinking.
- Board start error: LED on and fixed.
- Board configured in backup mode: LED off.

'SPD' green LED: indicates 1Gbps speed on primary link.

'LINK ACTIVITY' green LED: indicates active primary ethernet link.

'LAN 1' RJ45 type connector *: connects module to Dante primary network.

'LAN 2' RJ45 type connector *: connects module to Dante secondary network.

'SPD' green LED: indicates 1Gbps speed on secondary link.

'LINK ACTIVITY' green LED: indicates active secondary ethernet link.

*LAN 1 must always be wired, while LAN 2 is only used when the system is wired in "Daisy Chain" mode (to primary network) or a redundant system is set up (to secondary network).

Other characteristics and features.

- Internal warning signal indicating a failure in one of the power supplies. If a failure occurs, the "ALARM" LED on the BC2240 controller board will light up.
- Power feed circuit designed to support hot-swapping operations.

Programming jumpers.

This board has a series of internal programming jumpers (PJ). However, these jumpers are configured at the factory and, in normal operation, do not need to be changed.

Firmware modules.

At the firmware level, this board is made up of the following modules:

- **PIC microcontroller:** manages board communications and start-up.
- **FPGA programmable device:** manages the TDM bus and Dante AoIP module interface.
- **DANTE Brooklyn II module:** manages up to 64 AoIP Dante bidirectional audio channels.

The firmware versions can be brought up to date by using the "**BC2000D Firmware Upgrade**" and "**Dante Firmware Update Manager**" applications.

BC2214/BC2224 technical specifications.

- Gain, mute and phase control for all AoIP inputs/outputs.

AoIP Interface:

- Dante plug and play media networking.
- Synchronization IEEE 1588 Precision Time Protocol (PTP).
- Sub millisecond latency with +/- 1 microsecond synchronization.
- Up to 32x32 (BC2214) or 64x64 (BC2224) redundant bi-directional channels @ 48kHz.
- Audinate's patented Glitch-Free Redundancy.
- The most interoperable networking technology: works seamlessly with any other Dante-powered device.
- Network health, clock and audio quality monitoring.
- Gigabit Ethernet switch chip support.
- Dante works with standard off-the-shelf network switches - easily integrates into existing network switch infrastructure, and automatically discovers other Dante-enabled devices on the network.
- Firmware upgradeable.

General characteristics.

- Approximate consumption: 5 watts.
- Approximate dimensions:
 - Front: 17 x 172 mm.
 - Depth: 255 mm.
- Approximate weight: 263 grams.

Characteristics are subject to change without notice.

3.20. BC2215. E1/T1/J1 communications module.

General description.

The BC2215 board allows you to manage an standard E1, J1 o T1 link to transmit and receive audio channels (linear or encoded) and/or data channel.

This board is inserted into the rear part of the BC2000DF rack.

Panel description.

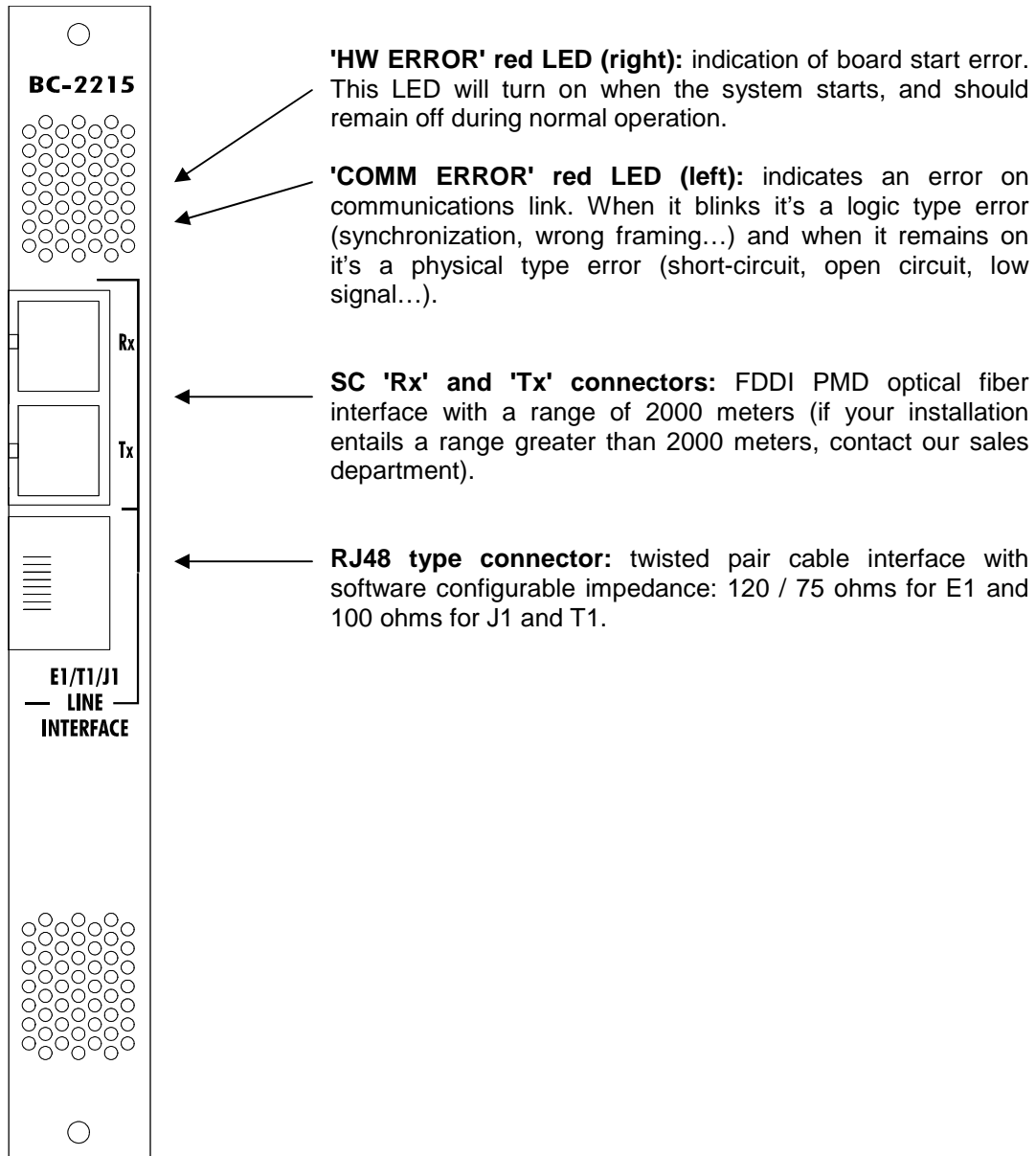

Other characteristics and features.

- Internal warning signal indicating a failure in one of the power supplies. If a failure occurs, the "ALARM" LED on the BC2240 controller board will light up.
- Power feed circuit designed to support hot-swapping operations.

Programming jumpers.

This board has a series of internal programming jumpers (PJ). However, these jumpers are configured at the factory and, in normal operation, do not need to be changed.

Signal layout in the RJ48 connectors of the board (standard mode).

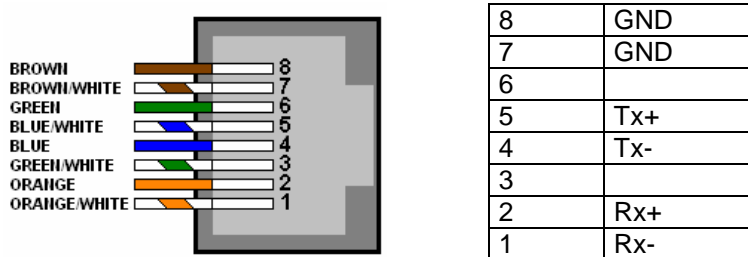

Firmware modules.

At the firmware level, this board is made up of the following modules:

- **PIC microcontroller:** manages board communications and start-up.
- **FPGA programmable device:** manages the TDM bus.

The firmware versions can be brought up to date by using the "BC2000D Firmware Upgrade" software application.

BC2215 technical specifications.

E1 Interface:

- 2048 Kbps: One 64 Kbps slot for synchronization y 1984 Kbps (31 slots) available.
- Selection of AMI or HDB3 line code. HDB3 compatible with ITU standard G703.
- Standard framework compatible with ITU G704.
- Line impedance: 120/75Ω software configurable.

T1 Interface:

- 1554 Kbps (1 bit per frame is used for frame and multiframe synchronization, alarm monitoring, etc.). 24 slots of 64 Kbps available.
- Selection of AMI or B8ZS line code. B8ZS compatible with ITU standard G703.
- Standard framework compatible with D4-ATT PUB 4801.
- Selection of superframe in 193S (12 frames per multiframe) or 193E (24 frames per multiframe) framing format.
- Line impedance: 100Ω.

J1 Interface:

- Characteristics similar to those of T1 interface with CRC6 management and yellow alarm according to the Japanese standard.

General characteristics.

- Approximate consumption: 4 watts.
- Approximate dimensions:
 - Front: 17 x 172 mm.
 - Depth: 255 mm.
- Approximate weight: 260 grams.

Characteristics are subject to change without notice.

3.21. BC2216. Ethernet communications module.

General description.

The BC2216 board allows you to transfer between the system and an Ethernet network data in order to lead them to a BC2215 board and send or receive that traffic through an E1/J1/T1 link.

This board is inserted into the rear part of the BC2000DF rack.

Panel description.

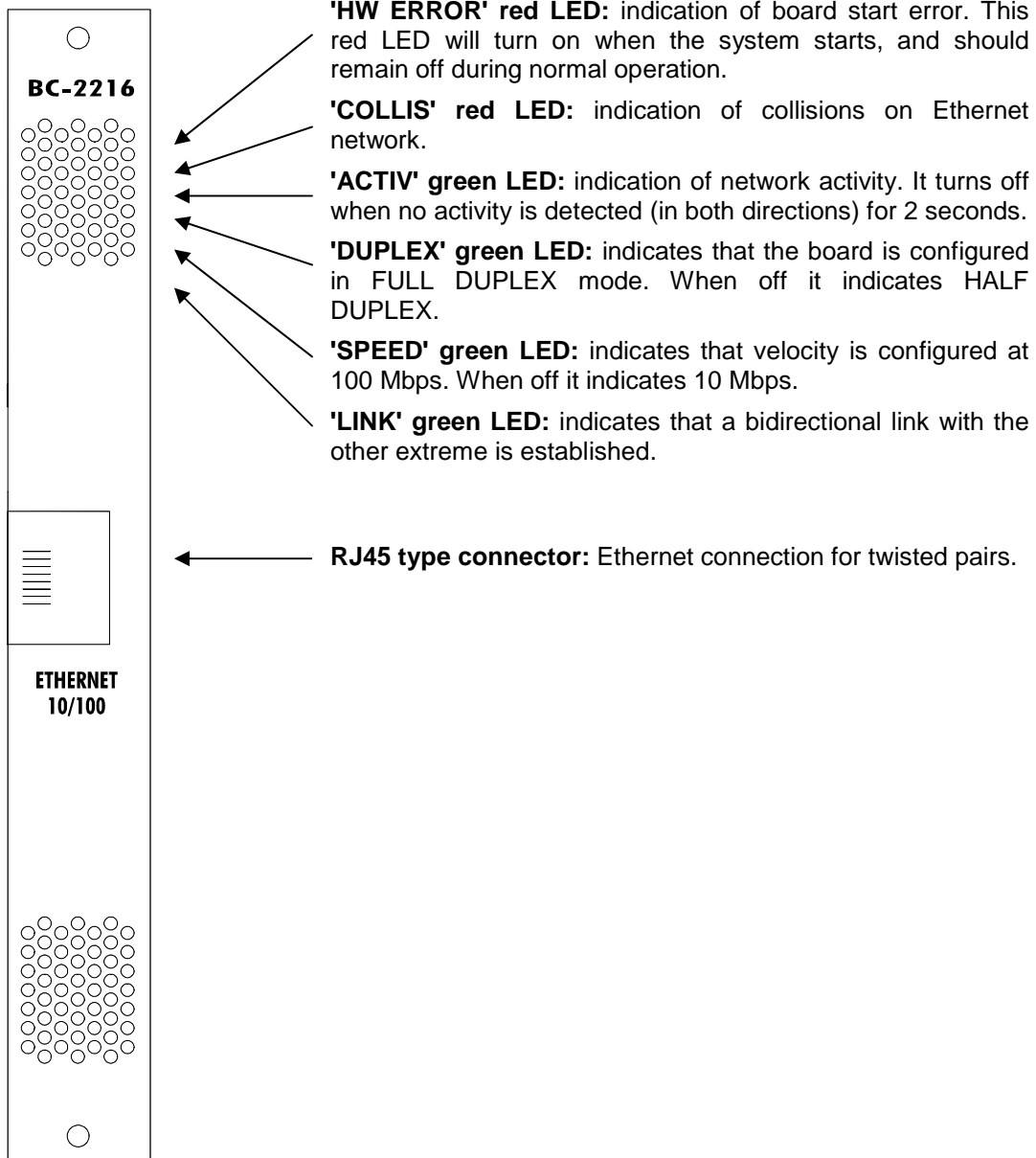

Other characteristics and features.

- Internal warning signal indicating a failure in one of the power supplies. If a failure occurs, the "ALARM" LED on the BC2240 controller board will light up.
- Power feed circuit designed to support hot-swapping operations.

Programming jumpers.

This board has a series of internal programming jumpers (PJ). However, these jumpers are configured at the factory and, in normal operation, do not need to be changed.

Firmware modules.

At the firmware level, this board is made up of the following modules:

- **PIC microcontroller:** manages board communications and start-up.
- **FPGA programmable device:** manages the TDM bus.

The firmware versions can be brought up to date by using the "BC2000D Firmware Upgrade" software application.

BC2216 technical specifications.

RJ45 interface:

- Ethernet connection for twisted pairs.
- Compatible with IEEE standard 802.3.
- Configurable in 10 base T / 100 base TX.
- Half duplex and full duplex modes.

General characteristics.

- Approximate consumption: 2 watts.
- Approximate dimensions:
 - Front: 17 x 172 mm.
 - Depth: 255 mm.
- Approximate weight: 252 grams.

Characteristics are subject to change without notice.

3.22. BC2217. CU (Commentary Unit) linking module.

General description.

The BC2217 board allows you to interconnect 1 or 2 CUs (Commentary Units) and the rest of Digital Commentary System. That link allows you to control and provide remote power to the CU, as well as transmit and receive the audio circuits associated with the unit.

This board is inserted into the rear part of the BC2000DF rack.

Panel description.

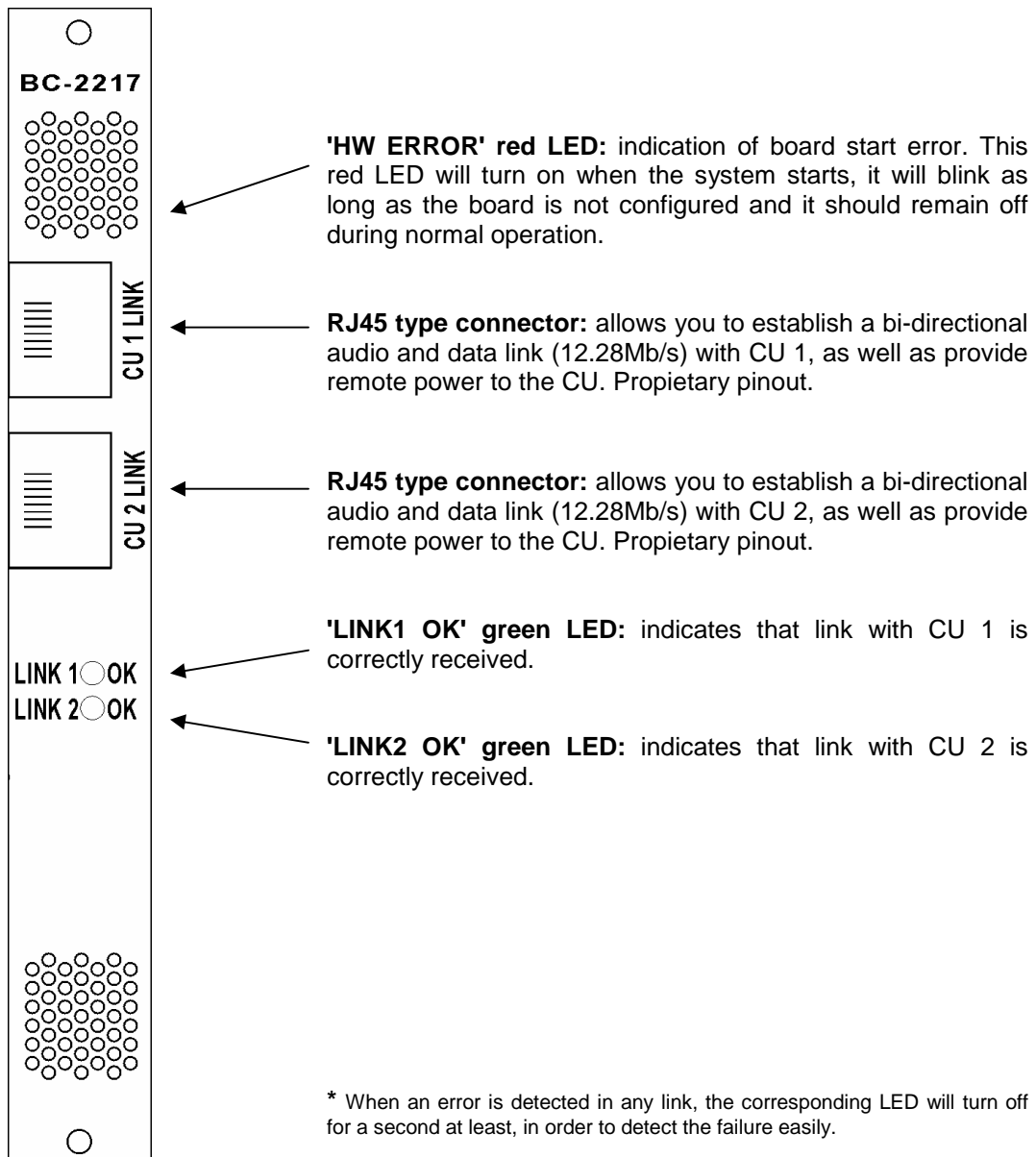

Other characteristics and features.

- Internal warning signal indicating a failure in one of the power supplies. If a failure occurs, the "ALARM" LED on the BC2240 controller board will light up.
- Power feed circuit designed to support hot-swapping operations.
- Bi-directional link able to transmit to/from the CU up to 8 lineal audio channels with broadcast quality (48KHz / 24 bits). In addition, there is bi-directional control channel with a 384Kbit/s capacity.
- Non volatile RAM memory able to store up to 8 audio messages with G722 encoding (8KHz / 8bits) and 32 seconds length (each one). These messages are read and recorded through TDM bus.
- Supervision system for the communication link with CU.
- Protection system against short-circuits o over-consumption for each CU.

Programming jumpers.

This board has a series of internal programming jumpers (PJ). However, these jumpers are configured at the factory and, in normal operation, do not need to be changed.

Firmware modules.

At the firmware level, this board is made up of the following modules:

- **PIC microcontroller:** manages board communications and start-up.
- **FPGA programmable device:** manages the TDM bus, the modems for communication with CUs and the access to non volatile RAM for messages storage.

The firmware versions can be brought up to date by using the "BC2000D Firmware Upgrade" software application.

Signal layout in the RJ 45 connectors of the board.

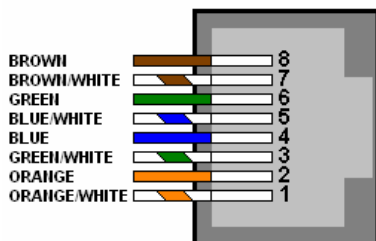

Pin	'CU 1 LINK'	'CU 2 LINK'
8	Rx 1-	Rx 2-
7	Rx 1+	Rx 2+
6	GND	GND
5	GND	GND
4	+48V	+48V
3	+48V	+48V
2	Tx 1-	Tx 1-
1	Tx 1+	Tx 1+
Chassis	GND	GND

BC2217 technical specifications.

RJ45 interface:

This interface consists of a audio+data digital link (12.288MHz) towards CU (it also extracts its synchronism from it) in a pair and another link from CU in another pair. The remaining wires are used to provide remote power (48V) to the CUs.

General characteristics.

- Approximate consumption: 4 watts (with no CUs connected).
- Approximate dimensions:
Front: 17 x 172 mm.
Depth: 255 mm.
- Approximate weight: 262 grams.

Characteristics are subject to change without notice.

3.23. BC2219. IP audio inputs/outputs module.

General description.

The BC2219 board allows you to handle up to 20 bidirectional PCM or G722 audio channels though IP at 100Mbps. It can be used for intercom and monitoring. Also provides 4 auxiliary analog outputs.

This board is inserted into the rear part of the BC2000DF rack.

Panel description.

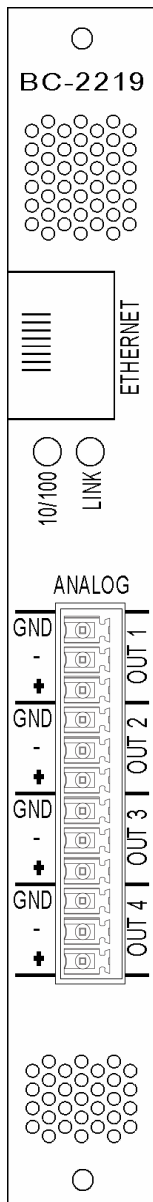

'HW ERROR' red LED: indication of board start error. This red LED will turn on when the system starts, it will blink as long as the board is not configured and it should remain off during normal operation.

'ETHERNET' RJ45 type connector: provides Ethernet connectivity at 10 or 100Mbps. The pinout is the standard one for IEEE802.3 over RJ45.

'10/100' green LED: when lighted up, it indicates that link with the next equipment is established at 100Mbps (although other network parts can limit the effective rate to 10Mbps). indicates that link with CU 1 is correctly received.

'LINK' green LED: when it's blinking, indicates there is activity in Ethernet link.

Multipin connectors: 4 analog monophonic outputs with line level, electronically balanced.

Other characteristics and features.

- Internal warning signal indicating a failure in one of the power supplies. If a failure occurs, the "ALARM" LED on the BC2240 controller board will light up.
- Power feed circuit designed to support hot-swapping operations.

Programming jumpers.

This board has a series of internal programming jumpers (PJ). However, these jumpers are configured at the factory and, in normal operation, do not need to be changed.

Firmware modules.

At the firmware level, this board is made up of the following modules:

- **FPGA programmable device:** manages the D/A converters and the communication with TDM bus.
- **Digital DSP signal processor:** manages board start-up, FPGA load, IP communications and signal processing. There are **two firmware modules** associated to DSP: the loader for start-up functions and the binary file for DSP itself, that includes the code that is executed once the board has started up.

NOTE: The three firmware files are physically stored in Flash memory associated to DSP.

The firmware versions can be brought up to date by using the "BC2000D Firmware Upgrade" software application.

Signal layout in the RJ45 connectors of the board.

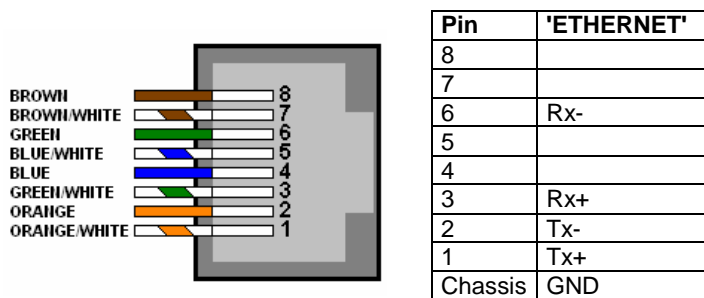

BC2219 technical specifications.

RJ45 interface:

This interface provides Ethernet connectivity at 10 or 100Mbps. The pinout is the standard one for IEEE802.3 over RJ45.

General characteristics.

- Approximate consumption: 5 watts maximum.
- Approximate dimensions:
 Front: 17 x 172 mm.
 Depth: 255 mm.
- Approximate weight: 319 grams.

Characteristics are subject to change without notice.

3.24. BC2220 and BC2221. DSP board. Processing, routing and VU meters management.

General description.

This board takes the data from the TDM IN bus, processes them and sends them to the appropriate TDM OUT bus, depending on the function assigned to the board. There are three types of functions that are internally assigned to DSP boards:

- a) Router: Manages a certain number of inputs and outputs, making crosspoints and modifying gains.
- b) Processor: Performs signal processing tasks.
- c) VU meters: Performs VU meter control tasks.

As many as 20 of these boards can be installed per rack. Depending on the capacities your installation requires, you will need a certain number of BC2220/BC2221 processing boards.

The main difference between BC2220 and BC2221 boards is that the last ones have a higher **process rate**, so the number of DSP boards required for a certain configuration, with a certain request of routing, processing and VU meters management, will be notably lower when you use BC2221 boards.

These boards are inserted into the **front part of the BC2000DF rack**, in the area protected by the front cover.

Panel description.

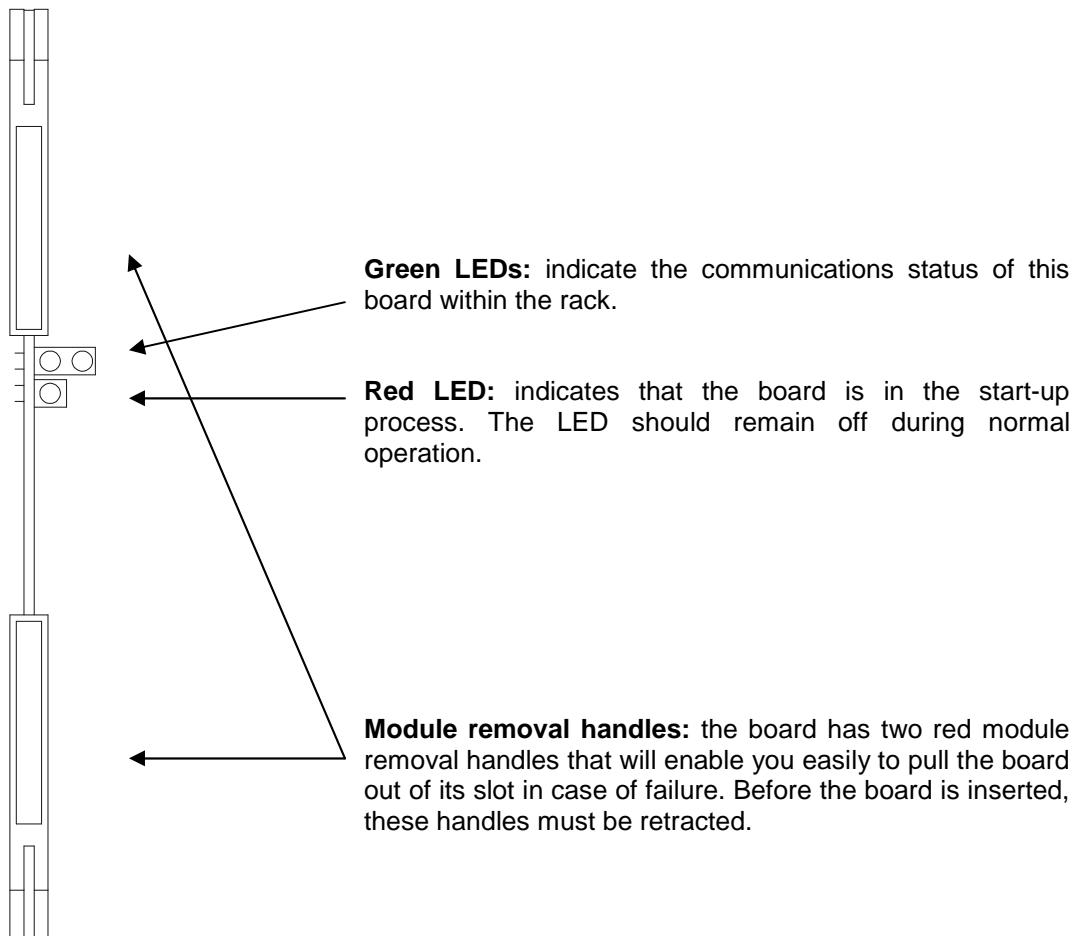

Other characteristics and features.

- Internal warning signal indicating a failure in one of the power supplies. If a failure occurs, the "ALARM" LED on the BC2240 controller board will light up.

Programming jumpers.

This board has a series of internal programming jumpers (PJ). However, these jumpers are configured at the factory and, in normal operation, do not need to be changed.

Firmware modules.

At the firmware level, this board is made up of the following modules:

- **PIC microcontroller:** manages board communications and start-up.
- **FPGA programmable device:** manages the TDM bus.
- **Digital DSP signal processor:** performs signal processing.

The firmware versions can be brought up to date by using the "**BC2000D Firmware Upgrade**" software application.

IMPORTANT NOTE: there are specific firmware versions for each type of board and, besides, there are different versions depending on the BC 2000 D system working mode as a mixing console or as a switching matrix.

General characteristics.

- Approximate consumption: 4 watts.
- Approximate dimensions:
 - Front: 14 x 150 mm.
 - Depth: 255 mm.
- Approximate weight: 180 grams.

Characteristics are subject to change without notice.

3.25. BC2240. Master Controller Module with USB, Ethernet and RS232/RS422 port.

General description.

BC2000D system controller. You can insert two controllers in the same rack for redundancy purposes so that, if the main controller fails, the other will take over the control of the system.

This board is inserted into the rear part of the BC2000DF rack.

Functional description.

The controller board is in charge of:

- managing the timing of the entire system, centralizing the synchronization sources.
- managing the power supply alarms generated in any of the boards, lighting the "ALARM" LED if it detects a failure.
- managing the master/slave mode (when two controller boards are used).
- it supplies the entire rack with power when a BC2290 or BC2291 external power supply is used.
- it includes a PC board with a real-time QNX operating system that is stored in a 512-Mb Compact Flash memory. This flash memory contains both the operating system and the configuration data.
- it allows you to record and play identification audio messages from PC board to/from the system through an ISA interface.

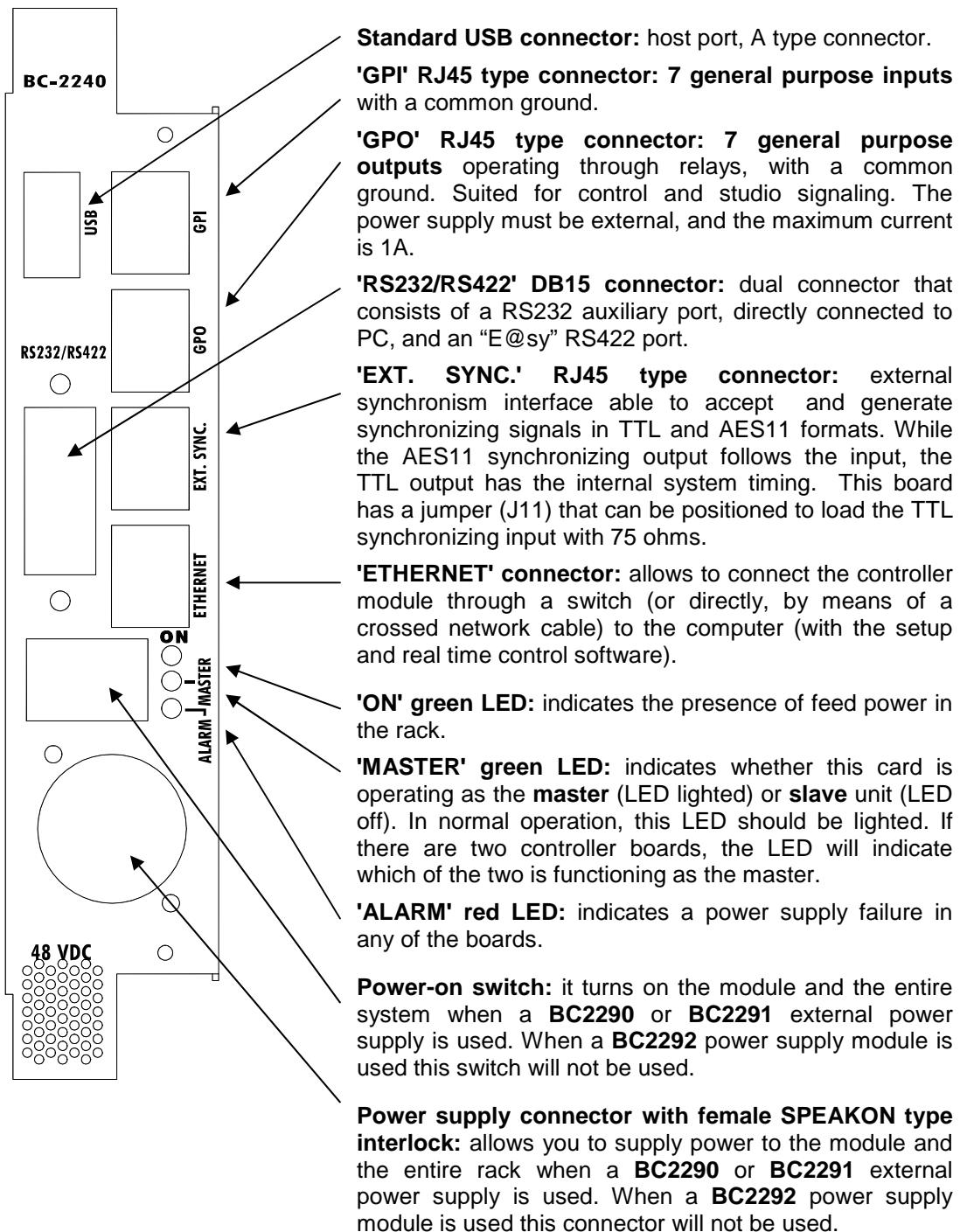

Firmware modules.

At the firmware level, this board is made up of the following modules:

- **PIC microcontroller:** manages board communications and start-up.
- **FPGA programmable device:** manages the alarms and the TDM bus.

The firmware versions can be brought up to date by using the "BC2000D Firmware Upgrade" software application.

Signal layout in the RJ45 connectors of the board.

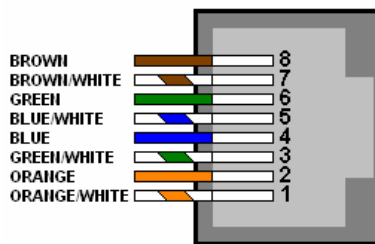

Pin	'GPI'	'GPO'	'EXT. SYNC.'
8	GPIGND	GPOGND	AES SYNC IN-
7	GPI7	GPO7	AES SYNC IN+
6	GPI6	GPO6	AES SYNC OUT-
5	GPI5	GPO5	AES SYNC OUT+
4	GPI4	GPO4	AGND
3	GPI3	GPO3	TTL SYNC OUT
2	GPI2	GPO2	TTL GND
1	GPI1	GPO1	TTL SYNC IN
Chassis	GND	GND	GND

NOTE: Pin layout corresponds to T568B standard.

BC2240 technical specifications.

External synchronism: AES3 and TTL.

GPI inputs:

- Inputs protected by optocoupler (4N35).
- Maximum input current: 60 mA.
- A voltage ranging between 5 V and 30 V will be applied.

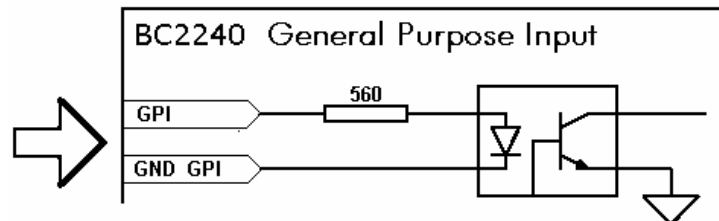

GPO outputs:

- By bistable relay (contact closing).
- Maximum current: 1 A @ 30 V DC, 0.5 A @ 125 V AC.
- Maximum voltage: 110 V DC or 125 V AC.
- Maximum power: 30 W, 62.5 VA.

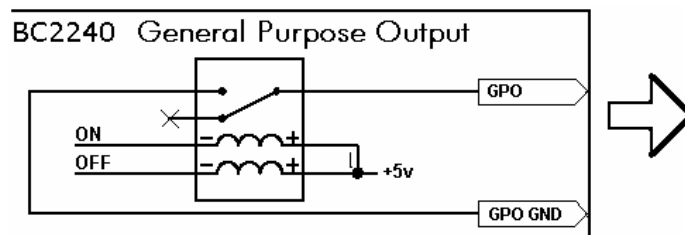

General characteristics.

- Approximate consumption: 10 watts.
- Approximate dimensions:
 - Front: 34 x 172 mm.
 - Depth: 255 mm.
- Approximate weight: 658 grams.

Characteristics are subject to change without notice.

3.26. BC2250. Front control panel.

General description.

The front control panel of the system allows you to activate/deactive remotely (with no need to use the real-time control software) the previously defined macros and gives you access to system status information.

This panel is connected into the **front part of the BC2000DF rack.**

Panel description.

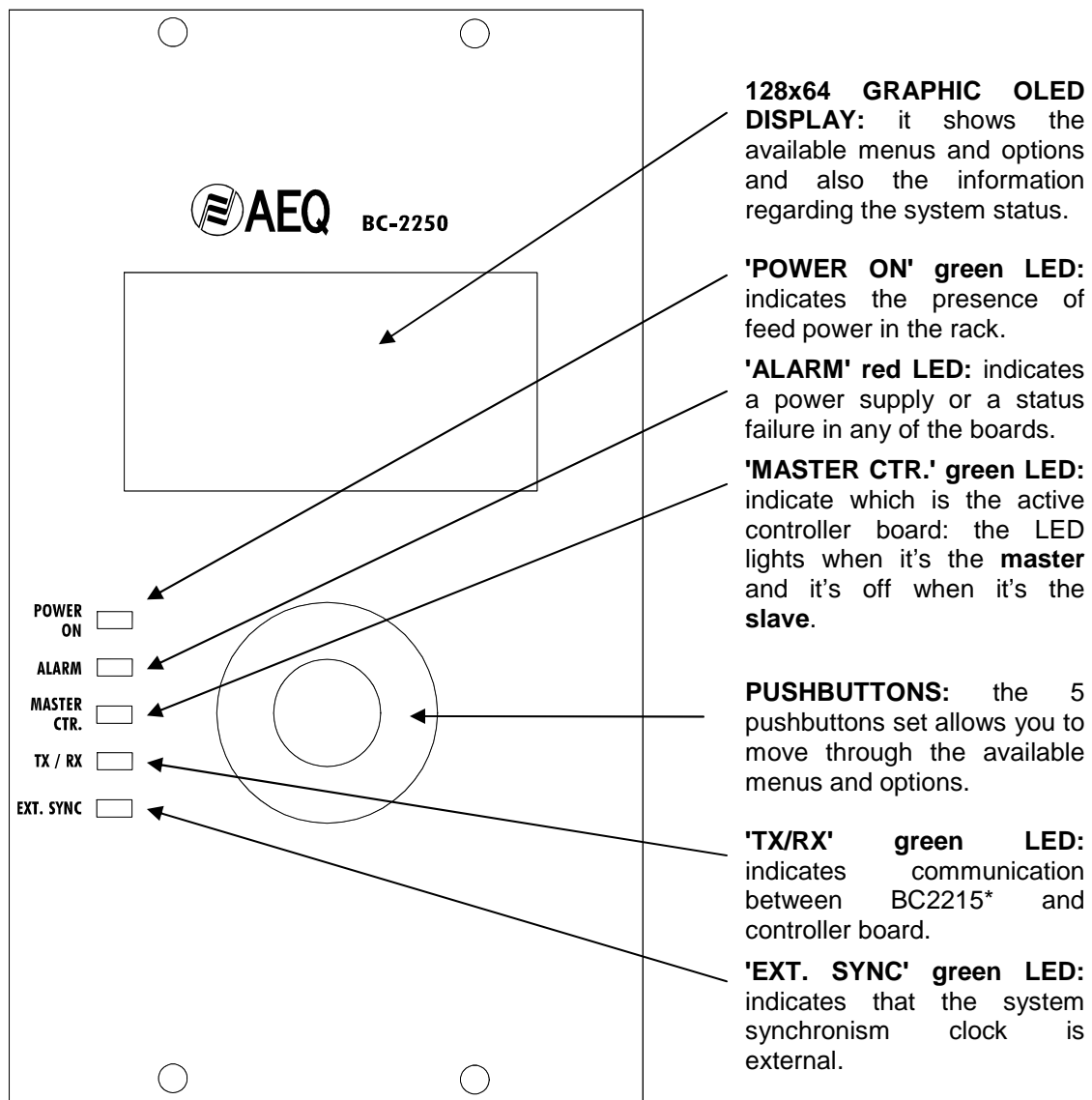

128x64 GRAPHIC OLED DISPLAY: it shows the available menus and options and also the information regarding the system status.

'POWER ON' green LED: indicates the presence of feed power in the rack.

'ALARM' red LED: indicates a power supply or a status failure in any of the boards.

'MASTER CTR.' green LED: indicate which is the active controller board: the LED lights when it's the **master** and it's off when it's the **slave**.

PUSHBUTTONS: the 5 pushbuttons set allows you to move through the available menus and options.

'TX/RX' green LED: indicates communication between BC2215* and controller board.

'EXT. SYNC' green LED: indicates that the system synchronism clock is external.

* See BC2000D Multiplexer system users manual.

Firmware modules.

At the firmware level, this board is made up of the following module:

- **PIC microcontroller:** manages board communications and start-up.

The firmware versions can be brought up to date by using the "**BC2000D Firmware Upgrade**" software application.

General characteristics.

- Approximate consumption: 7 watts.
- Approximate dimensions:
Front 99.5 x 172 mm.

Characteristics are subject to change without notice.

4. Power supplies.

4.1. BC2290. 2x300W Power Supply.

General description.

BC2000D system power supply. Delivers up to 300 watts between 1 and 5 48V DC outputs. This power supply is equipped with two 300-watt converters, one of which is normally operational while the other serves as a redundant back-up unit. The converters are accessible from the front panel and can be hot-swapped without having to power down the entire system.

Descripción del Panel Frontal.

A cover gives access to the two converters 'PS1' and 'PS2'.

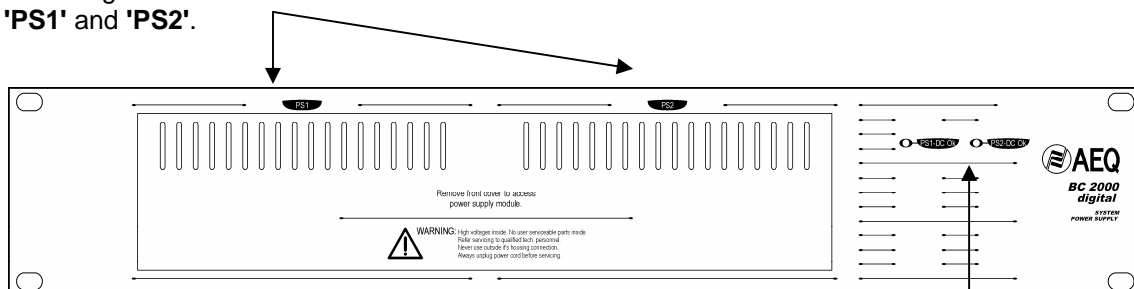

Two LEDs ('PS1-DC OK' and 'PS2-DC OK') indicate the operation of these two converters.

Rear Panel Description.

Uses connectors with SPEAKON type interlock.

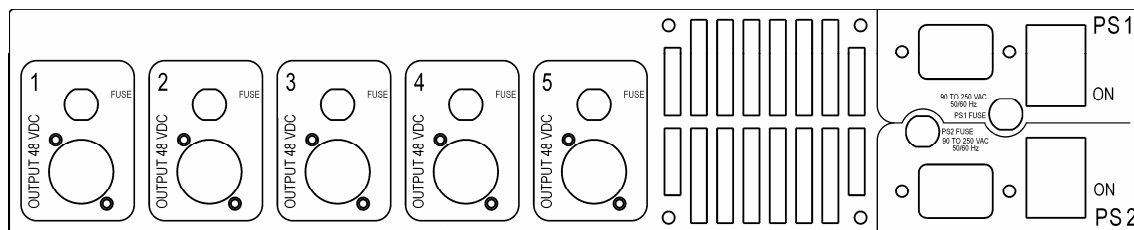

Associated with each of the 5 SPEAKON connectors is a fuse carrier holding a 5-Ampere Type T (timed) protective fuse.

Technical characteristics.

- Power supply: Autoranging, from 90 to 250 VAC, 50/60Hz, with automatic power factor correction.
- Output voltage: 48 volts DC.
- Maximum power: 300 W.
- Height: 2U.
- Depth: 340 mm.
- Weight: 8 kg.

Characteristics are subject to change without notice.

Loading of power receivers type-approved for BC2290.

To calculate the number of equipment items that can be connected to this power supply, add the estimated power consumption values for all the equipment and boards, leaving a 30-watts safety margin.

<u>Device</u>	<u>Estimated consumption</u>
BC2201 board	9 W
BC2202 board	4 W
BC2203M/BC2203ML board	6 W
BC2203MH/BC2203MHL board	7.5 W
BC2204/BC2205 board	9 W
BC2206/BC2207 board	4 W
BC2208/BC2208XF board	6 W
BC2209 board	8 W
BC2210 board	10 W
BC2211 board	8.5 W
BC2212 board	10.5 W
BC2312 board	10 W
BC2213 board	5 W
BC2214/BC2224 board	5 W
BC2215 board	4 W
BC2216 board	2 W
BC2217 board	4 W
BC2219 board	5 W
BC2220/BC2221 board	4 W
BC2240 board	10 W
BC2250 board	7 W

4.2. BC2291. 350W Power Supply.

General description.

BC2000D system power supply. Delivers up to 350 watts between 2 48 V DC outputs.

Front Panel Description.

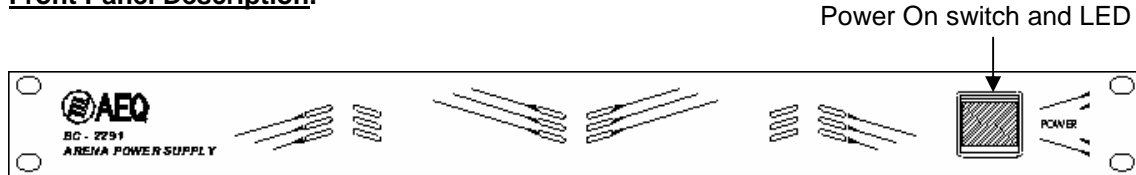

Rear Panel Description.

Uses connectors with SPEAKON type interlock.

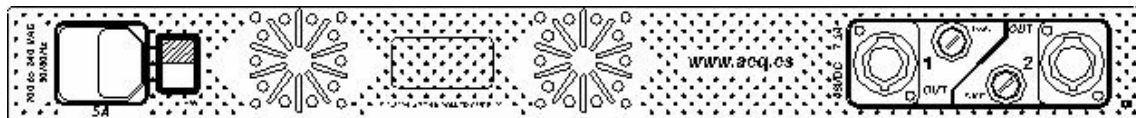

Associated with each of the SPEAKON connectors is a fuse carrier holding an 8-Ampere Type T (timed) protective fuse.

Technical characteristics.

- Power supply: Autoranging, from 90 to 250 VAC, 50/60Hz.
- Output voltage: 48 volts DC.
- Maximum power: 350 W.
- Height: 1U.
- Depth: 121 mm.
- Weight: 3 kg.

Loading of power receivers type-approved for BC2291.

To calculate the number of equipment items that can be connected to this power supply, add the estimated power consumption values for all the equipment and boards, leaving a 30-watts safety margin.

<u>Device</u>	<u>Estimated consumption</u>
BC2201 board	9 W
BC2202 board	4 W
BC2203M/BC2203ML board	6 W
BC2203MH/BC2203MHL board	7.5 W
BC2204/BC2205 board	9 W
BC2206/BC2207 board	4 W
BC2208/BC2208XF board	6 W
BC2209 board	8 W
BC2210 board	10 W
BC2211 board	8.5 W
BC2212 board	10.5 W
BC2312 board	10 W
BC2213 board	5 W
BC2214/BC2224 board	5 W
BC2215 board	4 W
BC2216 board	2 W
BC2217 board	4 W
BC2219 board	5 W
BC2220/BC2221 board	4 W
BC2240 board	10 W
BC2250 board	7 W

4.3. BC2292. 200W Power Supply Module.

General description.

BC2000D system power supply module. Delivers up to 200 watts. It can feed an entire frame.

You can insert two power supply modules in the same rack for N+1 redundancy purposes so that, if the main one fails, the other one will feed the system.

This board is inserted into the rear part of the BC2000DF rack.

Panel description.

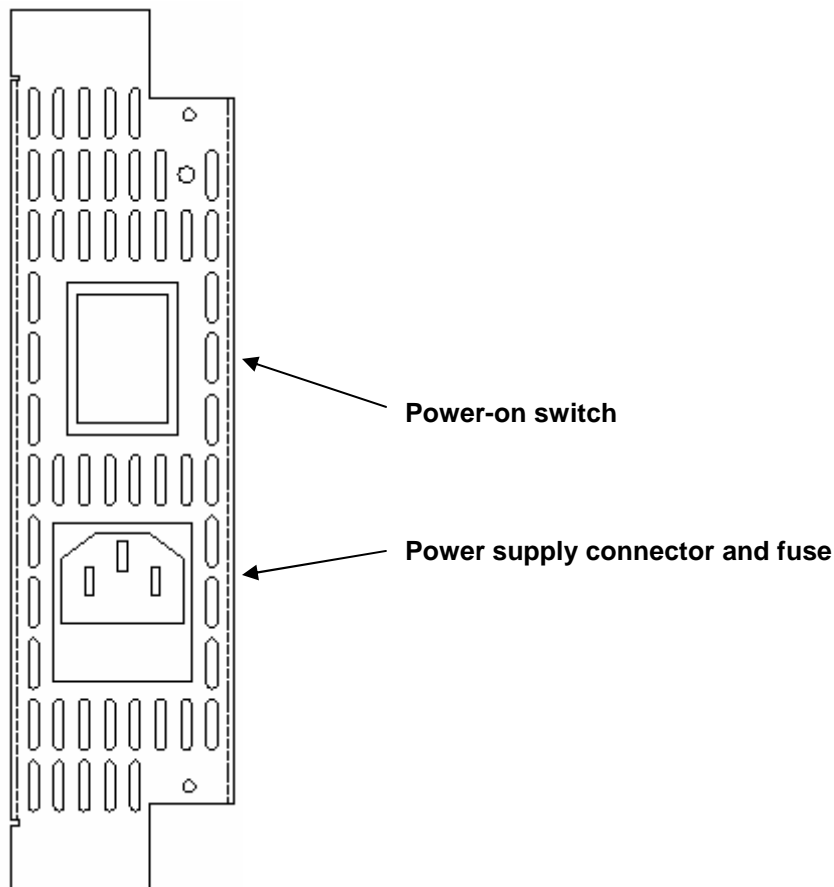

Technical characteristics.

- Universal input: from 90 to 250 VAC, 50/60Hz.
- Output voltage: 48 volts DC.
- Maximum power: 200 W.
- Approximate dimensions:
 - Front: 43 x 172 mm.
 - Depth: 145 mm.

Characteristics are subject to change without notice.

Loading of power receivers type-approved for BC2292.

To calculate the number of equipment items that can be connected to this power supply, add the estimated power consumption values for all the equipment and boards, leaving a 30-watts safety margin.

<u>Device</u>	<u>Estimated consumption</u>
BC2201 board	9 W
BC2202 board	4 W
BC2203M/BC2203ML board	6 W
BC2203MH/BC2203MHL board	7.5 W
BC2204/BC2205 board	9 W
BC2206/BC2207 board	4 W
BC2208/BC2208XF board	6 W
BC2209 board	8 W
BC2210 board	10 W
BC2211 board	8.5 W
BC2212 board	10.5 W
BC2312 board	10 W
BC2213 board	5 W
BC2214/BC2224 board	5 W
BC2215 board	4 W
BC2216 board	2 W
BC2217 board	4 W
BC2219 board	5 W
BC2220/BC2221 board	4 W
BC2240 board	10 W
BC2250 board	7 W

4.4. BC2293. 2x800W Power supply.

General description.

BC2000D system power supply. Delivers up to 800 watts between 1 and 5 48VDC outputs. This power supply is equipped with two 800-watt converters, one of which is normally operational while the other serves as a redundant back-up unit. The converters are accessible from the front panel and can be hot-swapped without having to power down the entire system.

Front Panel Description.

Two covers give access to the two converters 'PS1' and 'PS2'.

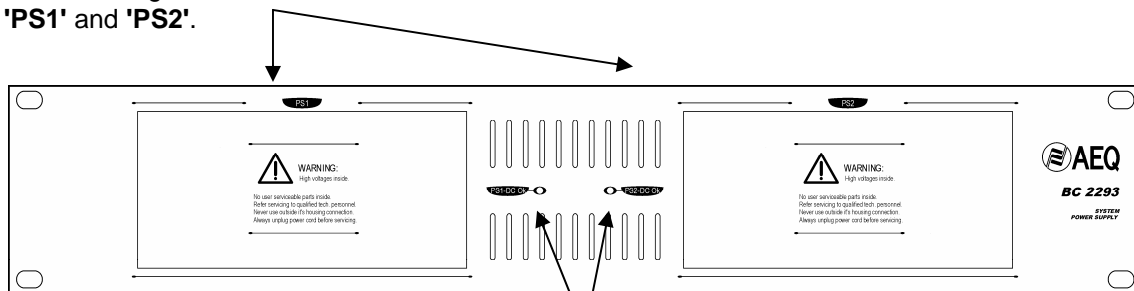

Two LEDs ('PS1-DC OK' and 'PS2-DC OK') indicate the operation of these two converters.

Rear Panel Description.

Uses connectors with SPEAKON type interlock.

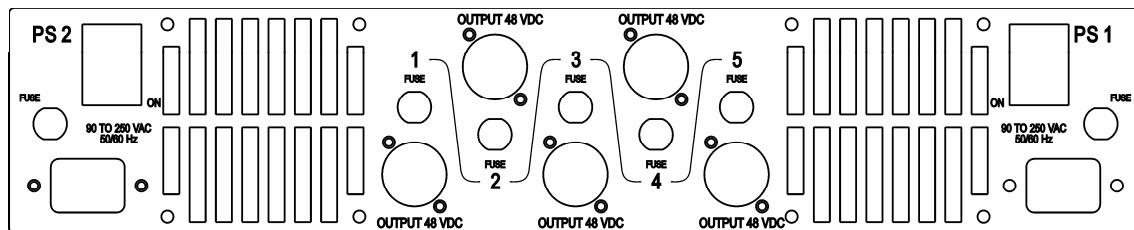

Associated with each of the 5 SPEAKON connectors is a fuse carrier holding a 20-Ampere Type T (timed) protective fuse.

Technical characteristics.

- Power supply: Autoranging, from 90 to 250 VAC, 50/60Hz, with automatic power factor correction.
- Output voltage: 48 volts DC.
- Maximum power: 800 W.
- Height: 2U.
- Depth: 340 mm.

Characteristics are subject to change without notice.

Loading of power receivers type-approved for BC2293.

To calculate the number of equipment items that can be connected to this power supply, add the estimated power consumption values for all the equipment and boards, leaving a 30-watts safety margin.

<u>Device</u>	<u>Estimated consumption</u>
BC2201 board	9 W
BC2202 board	4 W
BC2203M/BC2203ML board	6 W
BC2203MH/BC2203MHL board	7.5 W
BC2204/BC2205 board	9 W
BC2206/BC2207 board	4 W
BC2208/BC2208XF board	6 W
BC2209 board	8 W
BC2210 board	10 W
BC2211 board	8.5 W
BC2212 board	10.5 W
BC2312 board	10 W
BC2213 board	5 W
BC2214/BC2224 board	5 W
BC2215 board	4 W
BC2216 board	2 W
BC2217 board	4 W
BC2219 board	5 W
BC2220/BC2221 board	4 W
BC2240 board	10 W
BC2250 board	7 W

5. Standard wiring systems for BC-2000 D system.

Various wiring accessories and kits have been defined to make it easier to make the audio and GPI/GPO connections required by the BC 2000 D consoles and matrixes.

The high degree of integration of the BC 2000 D makes it possible to use 8-pole, high density, RJ45 type connectors on the input and output boards. Each one of these connectors is fitted with four audio or GPI/GPO circuits.

A complete accessory system has been prepared to make crossing connections easier between easily connected, highly integrated 3-pole WAGO connectors or the classic XLR audio connectors and the shielded 8-pole RJ45 connectors accepted by the BC2000DF rack boards.

We have even chosen several types of cable and connectors to supply “loose” to ease the work of wiring a studio equipped with a BC 2000 D system.

5.1. Individual connection components.

The following paragraphs describe the different types of individual elements we offer for wiring the BC 2000 D system.

5.1.1. BC 2000 CAB RACK chassis.

Code 620-000-000. 4 U x 19” connection rack that can house up to:

- 6 BC 2000 CAB W connection modules, each fitted with 12 circuits with WAGO male connectors, or
- 6 BC 2000 D CAB XLR connection modules, each fitted with 4 circuits with XLR connectors which can be male, female, or two male and two female connectors.

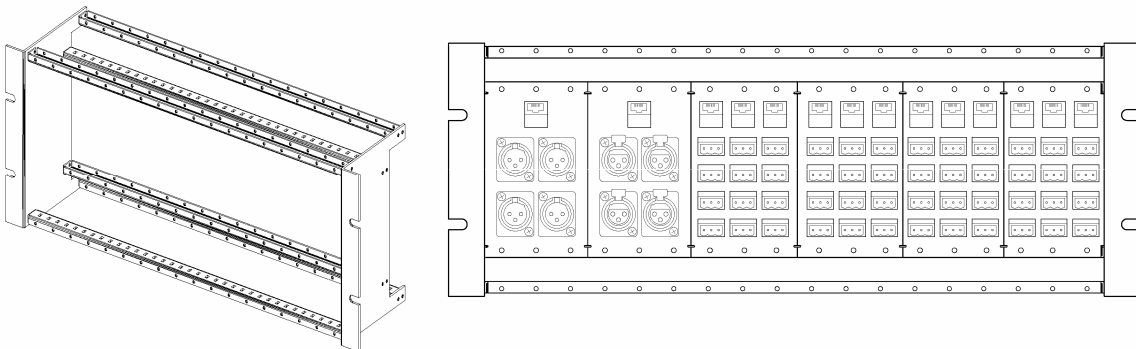

Its special design, with upper and lower slots that permit access to the rear part from the front panel, allows both the 8-pole plus ground RJ45 cables that go to the BC 2000 D rack and the 2-pole plus ground cables that come out of the WAGO or XLR connectors to be led in either from the front or rear panel.

Dimensions: 4 U x 19 “ (482.6 x 178 mm), 120 mm deep.
Approximate weight: 1,600 grams.

5.1.2. BC 2000 CAB W connection modules.

Code 620-000-001. BC 2000 CAB W.

Each connection module allows 3 shielded RJ45 ribbon cables to be connected and led out to the BC2000DF rack boards, and separates the four signals carried by each ribbon cable, taking each one of them to a WAGO 3-pole connector.

The ground pin of the WAGO connector is connected by default to system ground. If this is not appropriate, the ground pin can be isolated removing the necessary programming jumpers located in the back of the module. Programming jumpers J4, J7, J10 y J13 correspond to signals 1, 2, 3 and 4 of the left RJ45 connector. Programming jumpers J5, J8, J11 y J14 correspond to signals 1, 2, 3 and 4 of the central RJ45 connector. Programming jumpers J6, J9, J12 y J15 correspond to signals 1, 2, 3 and 4 of the right RJ45 connector. Programming jumper J16 connects metal chassis to system ground.

Each module is supplied with 12 easily connected WAGO exposed female connectors.

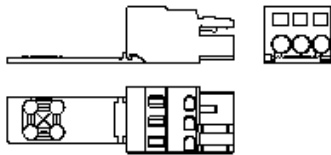

WAGO exposed female 3-pole connector. These connectors have a fast connection mechanism that works by simply inserting the wire, and a security system to ensure the retention of all the wiring.

RJ45 to WAGO conversion examples:

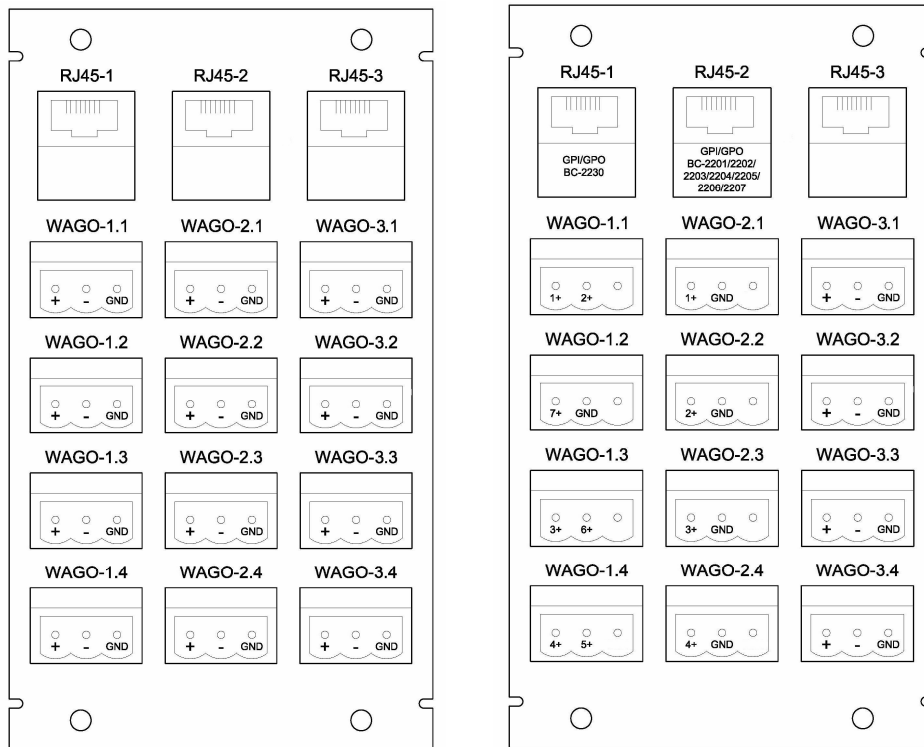

This type of module allows you to connect as many as 72 circuits in a single rack.

Dimensions: 71.6 x 122 mm.
Approximate weight: 130 grams.

5.1.3. RJ45 to 4 XLR connection modules.

- RJ45 to 4 XLR male connection modules. Code 522-900-501
- RJ45 to 4 XLR female connection modules. Code 620-000-002
- RJ45 to 2 XLR female and 2 XLR male connection modules. Code 522-900-503

Each connection module allows one shielded RJ45 ribbon cable to be connected and led out to the BC2000DF rack boards, and separates the four signals carried by the ribbon cable, taking each one of them to a 3-pole XLR connector. You may connect the ground pin of the XLR connector or not, as appropriate; the module has the necessary programming jumpers for this purpose (J1 for circuit 1, J2 for circuit 2 and so on).

The connection modules with XLR connectors male and female looks as follows:

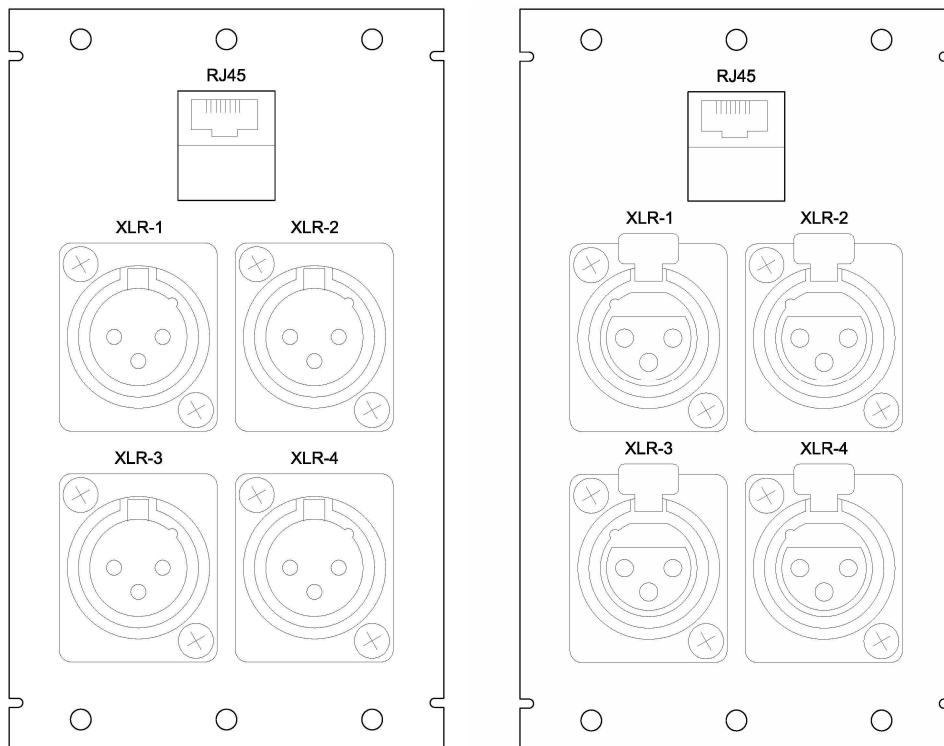

This type of module allows you to connect a maximum of 24 circuits in each rack.

XLR connector pin-out:

- Pin 1: GND
- Pin 2: V+
- Pin 3: V-

Dimensions: 71.6 x 122 mm.
Approximate weight: 233 grams.

5.1.4. Cables with connectors.

RJ45/RJ45 ribbon cables.

Shielded RJ45/RJ45 cables have been defined for installation between the connection module and the BC2000DF rack input and output boards. The 2-meter length is to be used when BC2000DF and BC 2000 CAB RACK are installed next to each other, and the 5-meter length will be used when you prefer to install them at a certain distance from each other.

- Code 522-900-902: RJ45/RJ45 shielded cable, 2 meters.
- Code 522-900-903: RJ45/RJ45 shielded cable, 5 meters.

XLR cables to connect audio equipment to the BC 2000 CAB W connectors.

The system supply includes 110-ohm cables in lengths of 4 meters. Optimal for digital and analog audio, these cables are fitted with one male or female XLR connector each, and prepared at the opposite end for insertion into the WAGO connectors included in the BC 2000 CAB W.

The purpose of this accessory is to provide you with cables that are ready to carry the signal from each piece of audio equipment in the studio to the connection rack.

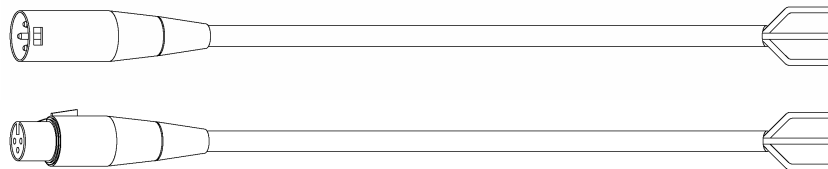

- Code 522-300-103: XLR male RED cable, 4 meters length, for insertion in WAGO male.
- Code 522-300-104: XLR male BLUE cable, 4 meters length, for insertion in WAGO male.
- Code 522-300-105: XLR female RED cable, 4 meters length, for insertion in WAGO male.
- Code 522-300-106: XLR female BLUE cable, 4 meters length, for insertion in WAGO male.

5.1.5. Loose cables and connectors.

Listed below are some types of cables and connectors that are highly useful for wiring BC 2000 D systems in radio studios.

Apart from this, the AEQ catalogue offers different 110-ohm multipair cable packs for digital and analog audio.

- 341-001-023: XLR exposed male connector.
- 341-001-013: XLR exposed female connector.
- 114-005-068 (PA-03 DR): Balanced 110-ohm red cable (100-meter reel).
- 114-005-069 (PA-03 DA): Balanced 110-ohm blue cable (100-meter reel).
- 114-005-067 (PA-03 DG): Balanced 110-ohm grey cable (100-meter reel).
- 114-005-011 (MI-206 N): Black microphone cable (100-meter reel).
- 114-005-012 (MI-206 R): Red microphone cable (100-meter reel).
- 114-005-013 (MI-206 A): Blue microphone cable (100-meter reel).

5.2. Wiring kits for BC 2000 D system.

5.2.1. Standard wiring kit.

Given below is the “Standard wiring kit” diagram showing the configuration of the wiring, racks and modules for a console of typical dimensions.

The description covers everything from the BC2000DF rack to the WAGO exposed 3-pole female connectors.

The great flexibility of the configuration will enable you to use it for other similar configurations and will allow easy expansions with the individual components described above.

Code 522-300-100. BC 2000 CAB STD: Standard wiring kit for the BC 2000 D.

It is made up of:

- BC 2000 CAB RACK: One 4 U x 19” connection rack.
- 5 units of BC 2000 CAB W, 3 RJ45 to 12 Wago connection modules including female connector.
- 1 unit of BC 2000 CAB MF, 1 RJ45 to 4 XLR female connection module.
- 16 units of 2-meter length of shielded RJ45/RJ45 cable.

DIAGRAM OF THE STANDARD WIRING KIT APPLIED TO A TYPICAL CONFIGURATION OF THE AEQ BC 2000 D CONSOLE

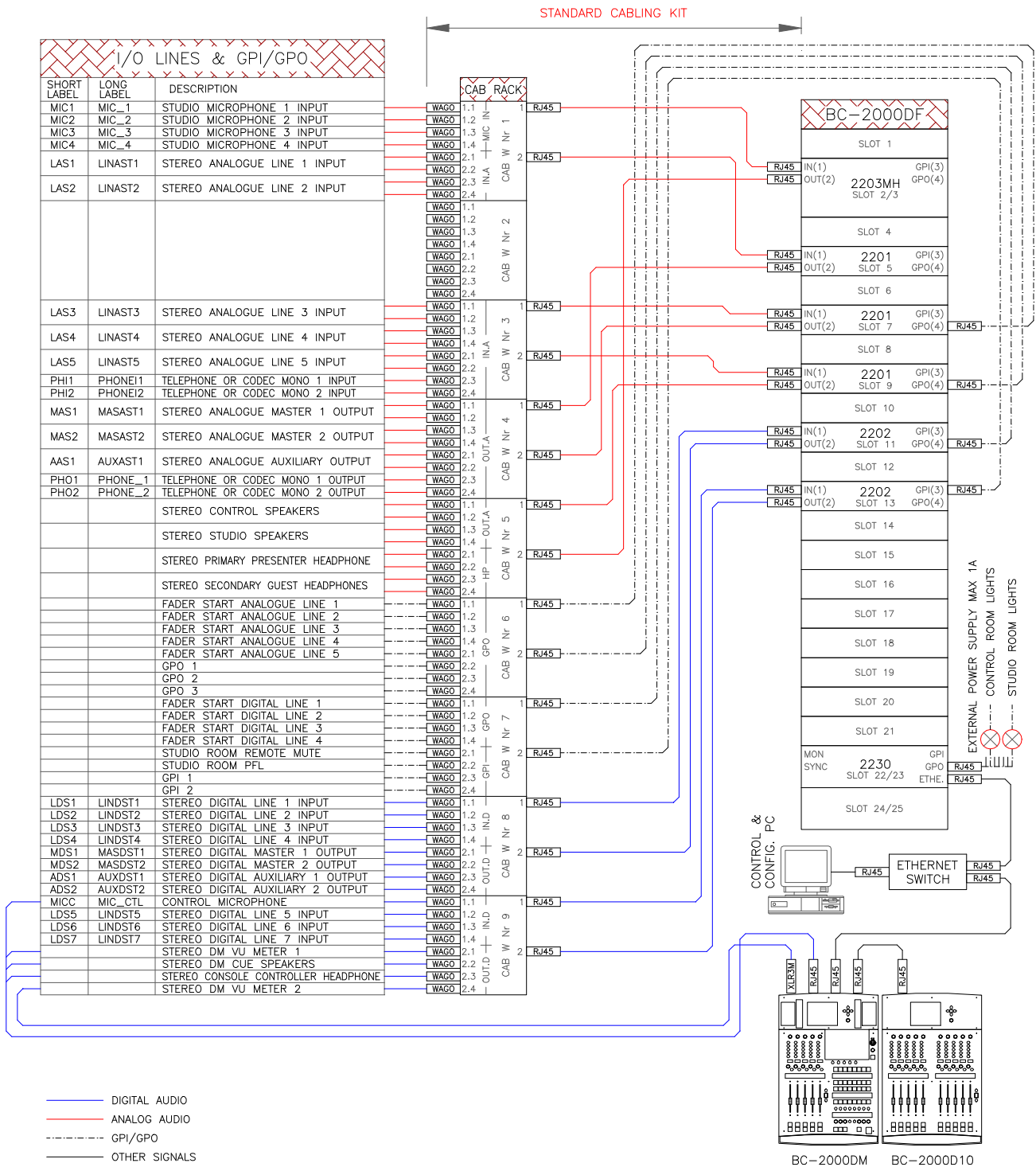

- DIGITAL AUDIO
- ANALOG AUDIO
- - - - - GPI/GPO
- OTHER SIGNALS

5.2.2. Additional control wiring.

To ensure that you will have the additional elements needed for wiring everything from the control equipment to the WAGO exposed female connectors that are supplied with the BC 2000 CAB W panels, we offer two additional component kits made up of cables for digital and analog audio and connectors. The two kits are alternatives; you will find one better suited to your needs than the other:

- **Additional control wiring kit for the standard BC 2000 (code 522-300-101).**
This kit is composed of cables and connectors you will need to custom-make each control cable:
 - One 100-meter reel of PA 03 DR red cable.
 - One 100-meter reel of PA 03 DA blue cable.
 - 25 male XLR connectors.
 - 25 female XLR connectors.

- **Additional control pre-wiring kit for the standard BC 2000 (code 522-300-102).**
This kit is composed of 32 prefabricated cables for the audio equipment items and more cable and other connectors for making the rest of the control cables:
 - 16 four-meter lengths of XLR male cable, BLUE, for insertion into male Wago.
 - 16 four-meter lengths of XLR male cable, RED, for insertion into male Wago.
 - One 100-meter reel of PA 03 DG gray cable.
 - 5 male XLR connectors.
 - 5 female XLR connectors.

6. Switch.

We strongly recommend, as shown in the standard configuration diagram, connecting the different consoles and racks, as well as a computer with the setup software, through a switch in each BC 2000 D installation. Any good quality switch can be used. If you are not sure which product to choose for the best operation, we offer a good AEQ-compatible switch which is available as a stand-alone or rack-mountable unit (1 U x 19") with universal power supply.

Code 390-003-181: Ethernet Switch, 16 ports, stand-alone or 1 U x 19 “.

When a direct connection (without switch) is established between the DM control surface and the frame, a crossed network cable should be used.

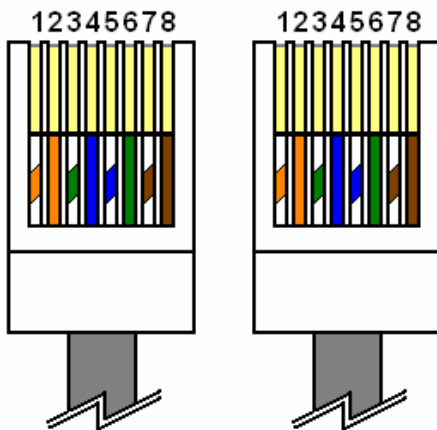
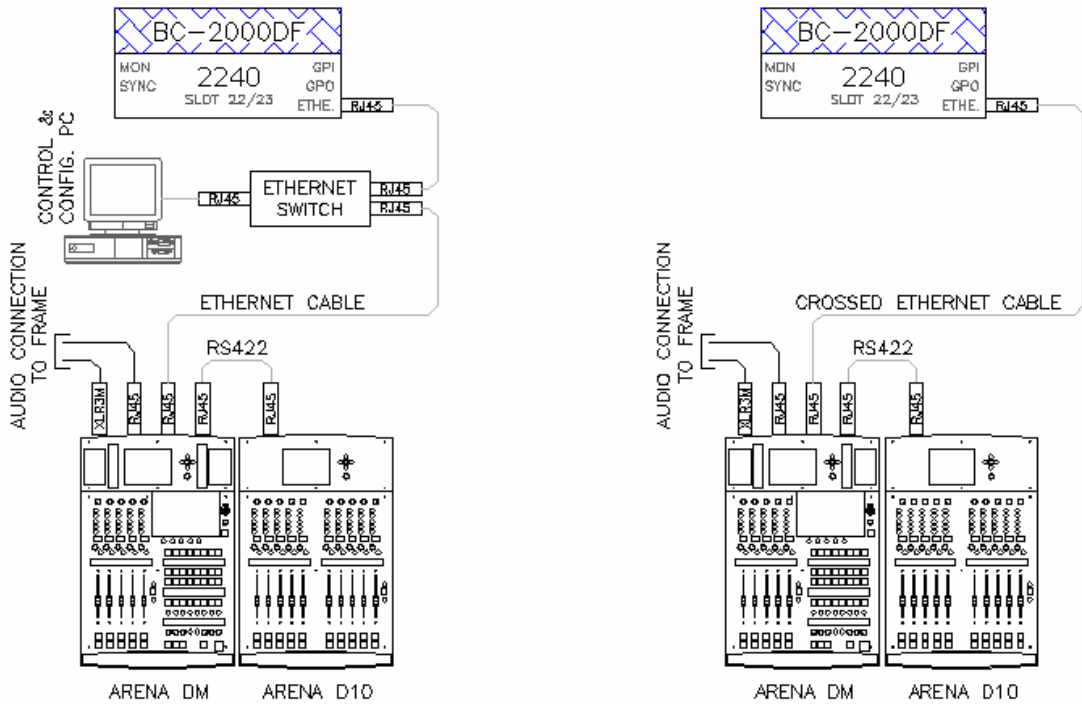

Normal ethernet cable pin layout
(T568B)

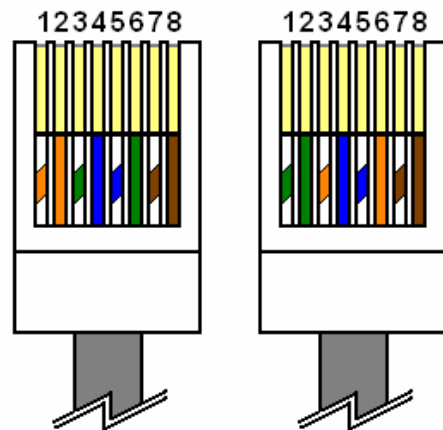

Cross ethernet cable pin layout
(T568B - T568A)

7. Control surfaces.

Only for wiring purposes, the ARENA DM and ARENA D10 control surfaces are described below. This equipment is described at a functional level in the relevant manual, which is written with the users in mind. In order to understand the connections better, refer to the diagram in section 3.2.1.

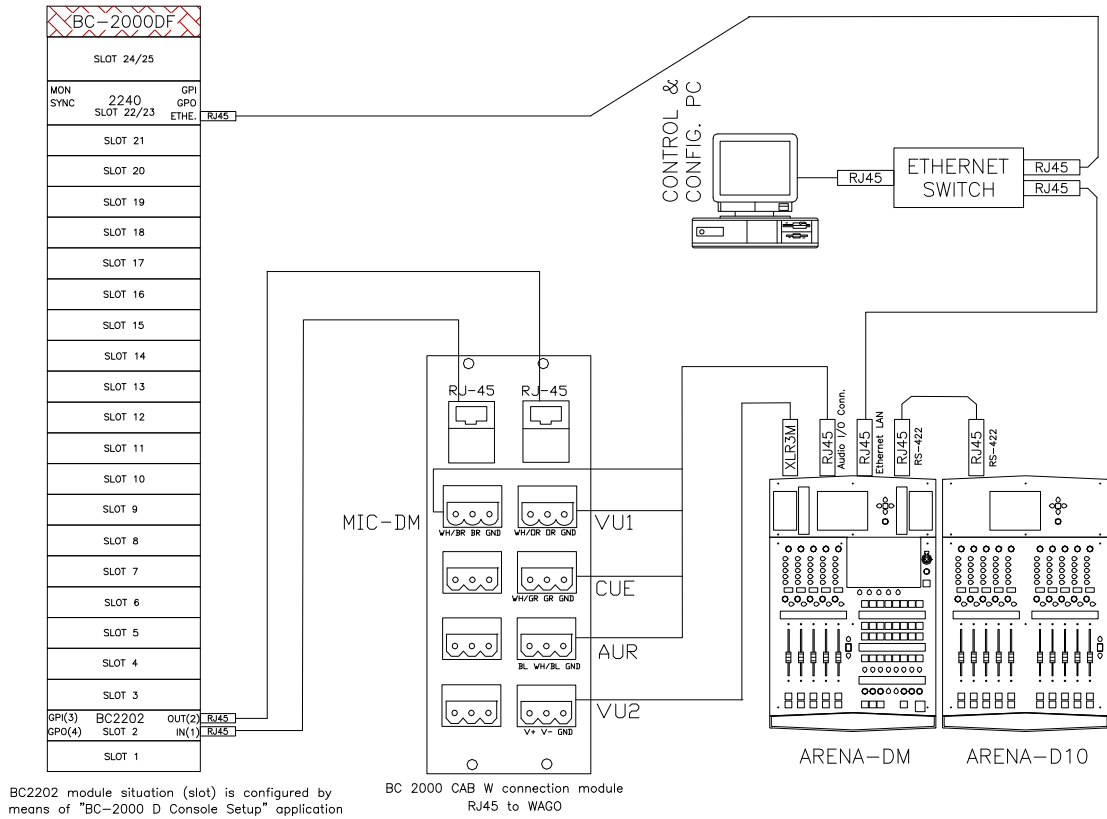

7.1. ARENA DM control module.

Composition of the supply *

- The module itself.
- One 2-meter power supply cable.
- 5-meter flexible, shielded, crossed local network cable to connect frame and console without switch.

* Console installation guide and CD with control surface setup software, firmware and complete console manuals are included in the Frame supply.

Connection and other rear panel elements.

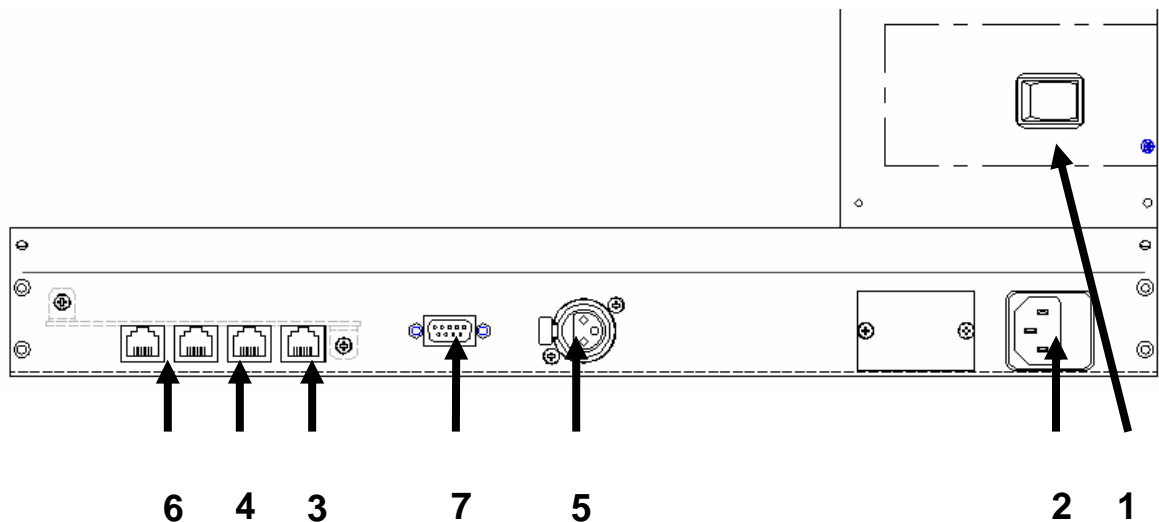

- 1. Power switch.
- 2. Power supply connector and fuse.
- 3. Ethernet LAN: Connector linking data with the controller: a standard Ethernet cable can be connected when connecting through a switch, or the crossed network cable that is supplied (labeled “Only direct to controller”) can be used when a direct connection is made.
- 4. RJ45 digital audio connector: Connects the digitalized output from the microphone input and the inputs for VU meter 1, CUE and the control headphones. Pin layout, from right to left, with the tongue facing up:

1. AES VU1 In+:	AES/EBU audio input for VU meter 1.
2. AES VU1 In-:	AES/EBU audio input for VU meter 1.
3. AES CUE In+:	AES/EBU audio input for CUE.
4. AES Headph In+:	AES/EBU audio input for the control headphones.
5. AES Headph In-:	AES/EBU audio input for the control headphones.
6. AES CUE In-:	AES/EBU audio input for CUE.
7. AES MIC Out+:	AES/EBU audio output from the ARENA DM microphone.
8. AES MIC Out-:	AES/EBU audio output from the ARENA DM microphone.

Cable is furnished to connect to BC 2000 CAB W module:

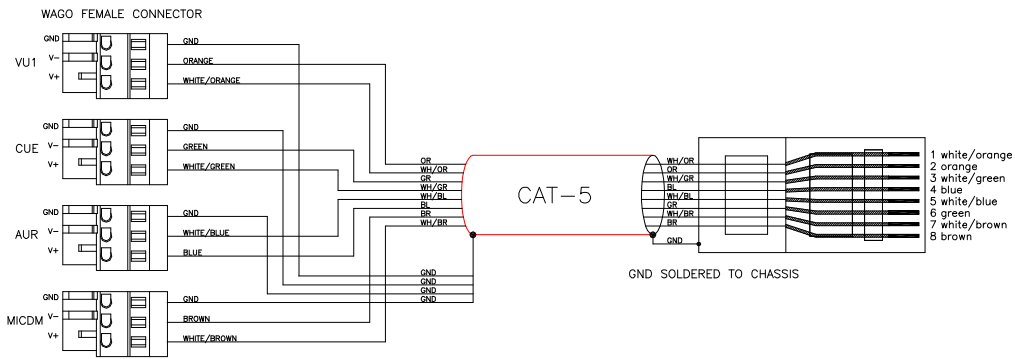

IMPORTANT NOTE: GND is soldered to chassis in RJ45 connector.

- **5. AES/EBU digital audio connector by XLR, to receive the input from VU meter 2.**
 1. GROUND.
 2. AES VU2 In +: AES/EBU audio input for VU meter 2.
 3. AES VU2 In -: AES/EBU audio input for VU meter 2.

The cable used to connect to BC 2000 CAB W module is as follows:

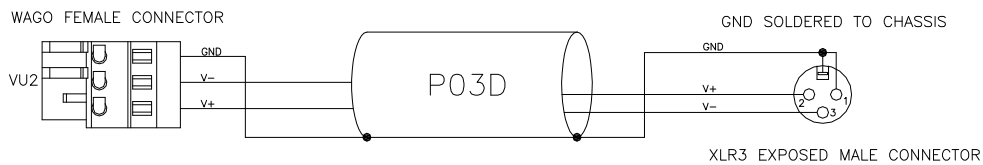

IMPORTANT NOTE: Pin 1 (GND) is soldered to chassis in XLR connector.

- **6. Pair of RS 422 control output RJ45 connectors for ARENA D10 channel expansion modules: 2 connectors. If you need to connect more (up to 7), each connector has a follower output that can be connected to the next one. Pin layout, from right to left, with the tongue facing up:**
 3. RX +.
 4. TX +.
 5. TX -.
 6. RX -.
 7. S clk +: V+ phase of the synchronizing signal.
 8. S clk -: V- phase of the synchronizing signal.

Normal Ethernet cable is used (according to T568B standard).

- **7. RS 232: serial Port: Connection via serial port for future applications.**

7.2. ARENA D10 channel expansion module.

Composition of the supply.

- The module itself.
- One 2-meter power supply cable.
- Flexible shielded RJ45/RJ45 cable for ARENA D10, 2 meters long.

Connection and other rear panel elements.

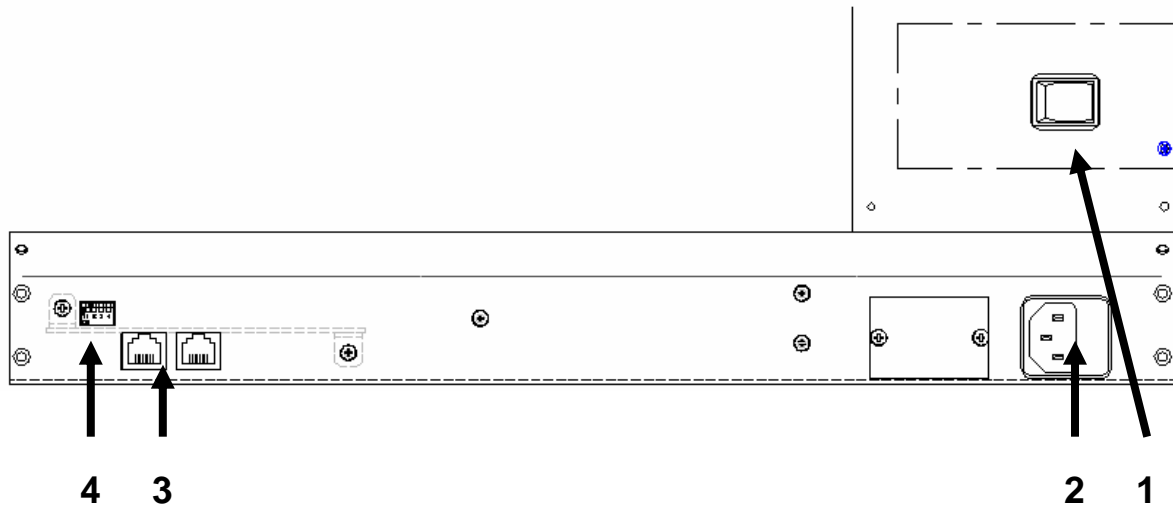

- 1. Power switch
- 2. Power supply connector and fuse.
- 3. Pair of RJ45 input and output connectors, where output follows the RS 422 control from the main ARENA DM module and toward others, for ARENA D10 channel expansion modules. Pin-to-pin connection (the cable furnished with each module can be used), since the pin layout is inverted in the equipment. Pin layout, from right to left, with the tongue facing up:
 3. TX +.
 4. RX +.
 5. RX -.
 6. TX -.
 7. S clk +: V+ phase of the synchronizing signal.
 8. S clk -: V- phase of the synchronizing signal.
- 4. Dip-Switch module. These switches are used to assign a different address to each ARENA D10 module that hangs from a ARENA DM, to prevent communications from colliding. Make sure, therefore, that in each ARENA D10 the position of the set of dip-switches is different from all the rest of the dip-switches.

8. TITAN. Router concentrator 5080 x 5080 audio channels.

General description.

TITAN concentrator is a high capacity (5080 x 5080 audio channels) digital audio router equipped with five bi-directional optical fiber ports, working each one at 2Gbps to transport 1016 24bits audio channels and 8 additional channels reserved for control and CRC checksum, using a non-blocking architecture.

All elements of the concentrator are hot-swappable, without having to power down the entire system, in a timely and efficient manner without removing the equipment from the rack:

- Any of the two power supplies (redundant, switching and auto-ranging) are accessible from the removable and hinged front panel. They have independent line AC connectors so they can be fed from two distinct electrical power distribution sources.
- The ventilation fans are also accessible from the front panel and, if necessary, can be removed from there.
- Any of the two controlling modules (also redundant), as well as the audio switching core module, are accessible from the back panel of the system.

Functional description.

As with the rest of the BC2000D system, the control system is based on a TCP/IP architecture, with 2 controller boards working in a cluster mode, giving the control interface access via a single virtual IP address.

Audio connections are made within the BC2000D system by means of five bi-directional optical fiber ports, which are directly compatible with the **BC2213** mode (see section 1.18 of this manual). By using this design, the 1024 x 1024 audio channels sub-routers can be connected to create a higher audio channel concentration (up to 5080 x 5080), while still maintaining the non-blocking characteristics.

Front Panel Description.

System **ventilation** grilles, with 2 ventilation fans installed each side.

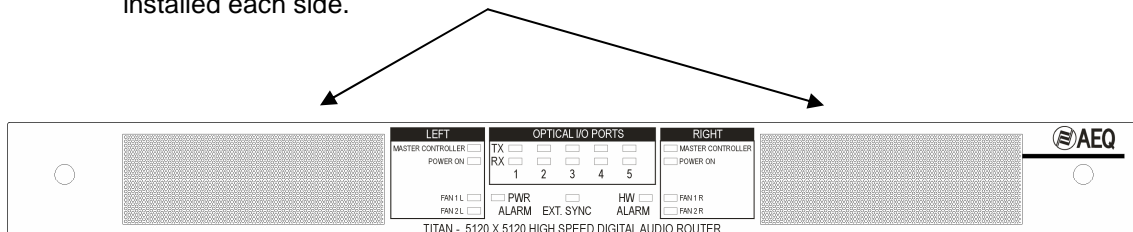

LEDs front panel for system status information.
See detailed description on the next page.

'MASTER CONTROLLER' LEDs: indicate which controller module (left or right) is working as **master** (LED on) or **slave** (LED off).

'POWER ON' LEDs: indicate the presence of feed power from each power supply.

'FAN 1L', 'FAN 2L', 'FAN 1R' y 'FAN 2R' LEDs: indicate a failure in one of the 4 system ventilation fans when turning to red.

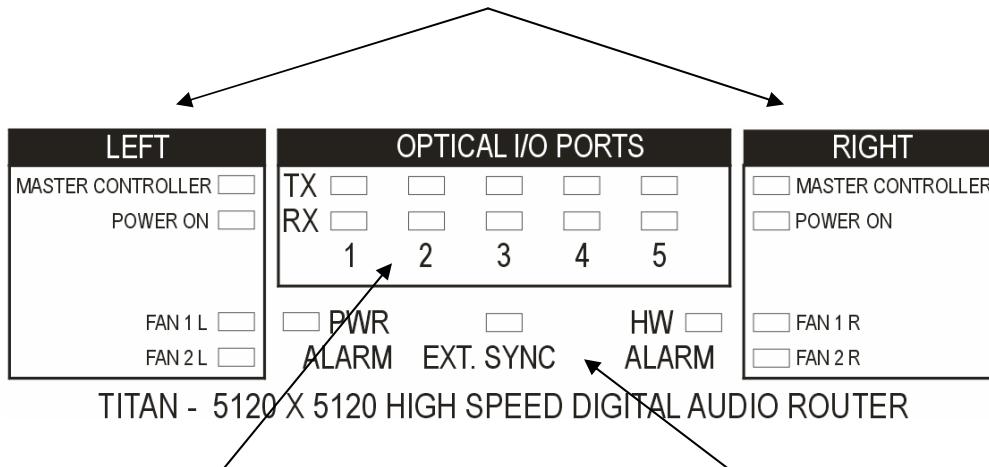

'TX' and 'RX' LEDs: when lighted in green indicate communication between each one of the 5 bi-directional optical fiber ports and the associated BC2213 module.

When 'TX' LED turns to red indicates an alarm in the corresponding optical fiber transmitter.

When 'RX' LED turns to red indicates an alarm in the optical fiber receiver because no reception signal is detected.

'POWER ALARM' LED: indicates a power supply failure (for instance, one of the two power supplies is not working or is switched off).

'EXT. SYNC' LED: indicates that the system synchronism clock is external.

'HW ALARM' LED: indicates that the audio router is not working, that the hardware configuration for its correct operation has failed.

Rear Panel Description.

Controller modules

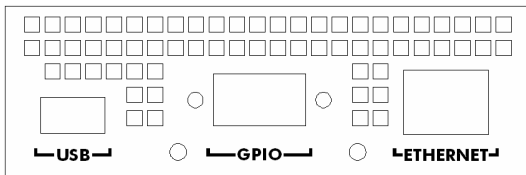

Standard USB connector: host port, A type connector.

'GPIO' DB9 type connector: 4 general purpose inputs and 3 general purpose outputs with a common ground.

'ETHERNET' connector: allows to connect the controller module through a switch (or directly, by means of a crossed network cable) to the computer (with the setup and real time control software).

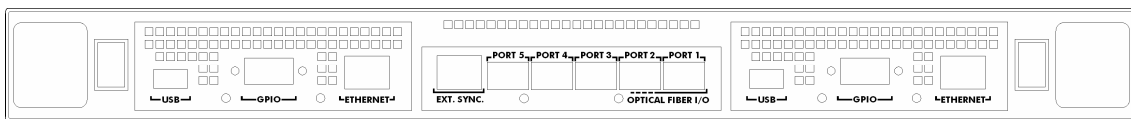

Audio communications ports module

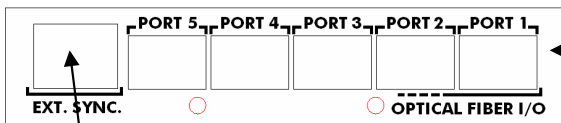

'EXT. SYNC.' RJ45 type connector: external synchronism interface able to accept and generate synchronizing signals in AES11 formats. The AES11 synchronism output is follower of the input.

LC 'PORT 1' to 'PORT 5' connectors: SFP (Small Form Pluggable) optical fiber transceiver, removable and interchangeable without tools, with a range of 150 meters (for 62.5/125 μ m MULTIMODE fiber) or 300 meters (for 50/125 μ m MULTIMODE fiber). For MONOMODE fiber and its corresponding SFP transceivers much higher distances can be reached (>10km).

Firmware modules.

At the firmware level, this board is made up of the following modules:

- **PIC microcontroller:** manages board communications and start-up.
- **FPGA programmable device:** manages the alarms and the audio channels of the 5 high speed links (including its routing).

The firmware versions can be brought up to date by using the "**BC2000 Firmware Upgrade**" software application.

TITAN technical characteristics.

External synchronism: AES11.

GPI inputs:

- Inputs protected by optocoupler (4N35).
- Maximum input current: 60 mA.
- A voltage ranging between 5 V and 30 V will be applied.

GPO outputs:

- By bistable relay (contact closing).
- Maximum current: 1 A @ 30 V DC, 0.5 A @ 125 V AC.
- Maximum voltage: 110 V DC or 125 V AC.
- Maximum power: 30 W, 62.5 VA.

Optical fiber interface:

- Type: SFP (Small Form Pluggable). Package style duplex LC.
- Nominal range:
 - 150 meters for 62.5/125µm MULTIMODE fiber (MMF).
 - 300 meters for 50/125µm MULTIMODE fiber (MMF).
 - >10 Km for 1310nm MONOMODE fiber (SMF).
- Transmission: LED, 850 nm.

Power supplies:

- 2 redundant power supplies, working in parallel mode with independent inputs.
- Input voltage: from 90 to 250 VAC, 50/60Hz.
- Output voltage: 48 volts DC.
- Maximum power: 40VA per module.

General characteristics.

- Approximate consumption: 28 watts.
- Height: 1U.
- Depth: 320 mm.

Characteristics are subject to change without notice.

9. Additional information.

NOTE: This equipment complies with the limits for a Class A digital device, pursuant to part 15 of the **FCC** Rules. These limits are designed to provide reasonable protection against harmful interference when the equipment is operated in a commercial environment. This equipment generates, uses, and can radiate radio frequency energy and, if not installed and used in accordance with the instruction manual, may cause harmful interference to radio communications. Operation of this equipment in a residential area is likely to cause harmful interference in which case the user will be required to correct the interference at his own expense.