



AEQ PHOENIX ALIO

Portable IP Audiocodec that is easy to configure and use
Optimized for OPUS encoding algorithms



USER'S MANUAL

ED. 02/23

V. 1.1 - 13/03/2023

Firmware Versions:
Software Version:

CPU 10.30 / DSP 3.36 / FPGA 5.54 or higher
AEQ ControlPHOENIX 2.2.2.1 or higher

CONTENTS

1. INTRODUCTION.....	5
1.1. General description.....	5
1.2. Technical characteristics.....	5
1.3. Available encoding algorithms.....	6
1.4. Block diagram.....	7
1.4.1. Internal diagram.....	7
1.4.2. Audio matrix.....	8
1.5. Compatibility with other AEQ codecs.....	10
1.6. Compatibility with third-party codecs.....	10
2. PHYSICAL DESCRIPTION OF THE UNIT.....	11
2.1. Description of the right panel and connections.....	11
2.1.1. Headphone 1 and 2 outputs.....	11
2.1.2. Line inputs ("LINE IN").....	11
2.1.3. Line outputs ("LINE OUT").....	12
2.2. Description of the back panel and connections.....	12
2.2.1. Microphone inputs ("MIC1", "MIC2", "MIC3" and "MIC4").....	12
2.2.2. Ethernet port.....	13
2.2.3. Power supply.....	13
2.2.3.1. Using an external powerbank as an UPS.....	14
3. USER INTERFACE DESCRIPTION. MANUAL CONTROL.....	16
3.1. OLED Screen.....	17
3.2. Navigation / Channel encoder ("NAVI / Ch").....	18
3.3. Vumeters.....	18
3.4. Alphanumeric keyboard and call buttons.....	19
3.5. Inputs control.....	20
3.6. Outputs control.....	21
3.7. Function keys.....	23
3.7.1. MODE keys ("IP" and "SIP").....	23
3.7.2. "AUTO" key.....	24
3.7.2.1. SmartRTP / AutoAnswer.....	24
3.7.2.2. Auto Hang-Up.....	24
3.7.2.3. Permanent call.....	24
3.7.3. "CODEC" key.....	25
3.7.4. "HELP" key.....	26
3.7.5. "MENU" key.....	26
3.7.5.1. "PRESETS" submenu.....	27
3.7.5.2. "ETHERNET" submenu.....	27
3.7.5.3. "COMMUNICATIONS" submenu.....	28
3.7.5.4. "MAINTENANCE" submenu.....	29
3.7.5.5. "SPECIAL FEATURES" submenu.....	31
4. CONFIGURATION AND OPERATION FROM REMOTE CONTROL SOFTWARE.....	32
4.1. Individual codec control window.....	32
4.1.1. CONFIG Menu.....	33
4.1.2. Mixer control window.....	36
4.1.3. Vumeters window.....	37
4.2. Connection modes.....	38
4.2.1. RTP Point to Point (RAW).....	38
4.2.2. PROXY SIP.....	39
4.2.3. DIRECT SIP.....	41
4.2.4. Sending audio to multiple destinations: Broadcast, Multicast and Multi-unicast.....	43
4.3. NAT TRAVERSAL.....	46
4.3.1. Operation without NAT: "OFF (there is no NAT)".....	47
4.3.2. Manual NAT: "MANUAL (router configuration)".....	47
4.3.3. AUTO 1 (local network audio).....	48

4.3.4. AUTO 2 (local network audio).....	48
4.3.5. AUTO 3 (audio over internet).....	48
4.3.6. AUTO 4 (audio over internet).....	49
4.4. FEC modes and reception buffer configuration.....	49
4.5. Coding algorithm selection.....	50
4.6. Ethernet Port configuration.....	51
4.7. SNMP configuration.....	51
4.8. Password configuration.....	53
4.9. User interface lock.....	54
5. QUICK USER'S GUIDE. LOCAL OPERATION.....	56
5.1. Connecting the unit.....	56
5.1.1. Power supply.....	56
5.1.2. Audio.....	56
5.1.3. Communications interface.....	56
5.2. Turning the unit on.....	56
5.3. Establishing a communication.....	56
5.3.1. Establishing an IP communication in RTP mode using <i>SmartRTP</i>	57
5.3.1.1. Ending an IP communication in RTP mode.....	58
5.3.2. Establishing an IP call in PROXY SIP mode.....	59
5.3.2.1. Ending an IP call in PROXY SIP mode.....	60
5.3.2.2. Receiving and accepting an IP call in PROXY SIP mode.....	60
5.3.3. Establishing an IP call in DIRECT SIP mode.....	61
5.3.3.1. Ending an IP call in DIRECT SIP mode.....	62
5.3.3.2. Receiving and accepting an IP call in DIRECT SIP mode.....	62
6. QUICK START GUIDE. REMOTE CONTROL.....	64
6.1. Equipment connections.....	64
6.1.1. Power supply.....	64
6.1.2. Communications interface.....	64
6.2. Turning the unit on.....	64
6.3. Setting up a computer to control the unit.....	64
6.4. Audio.....	65
6.5. Establishing an IP communication.....	65
6.5.1. Establishing an IP communication in RTP mode using <i>SmartRTP</i>	65
6.5.1.1. Ending an IP communication in RTP mode.....	67
6.5.2. Establishing an IP call in PROXY SIP mode.....	67
6.5.2.1. Ending an IP call in PROXY SIP mode.....	70
6.5.2.2. Receiving and accepting an IP call in PROXY SIP mode.....	70
6.5.3. Establishing an IP call in DIRECT SIP mode.....	71
6.5.3.1. Ending an IP call in DIRECT SIP mode.....	73
6.5.3.2. Receiving and accepting an IP call in DIRECT SIP mode.....	73
7. CONTROL TERMINAL OVER WEB BROWSER.....	75
7.1. Upgrading system firmware.....	75
7.2. Configuring the IP parameters and the MAC address associated with the Ethernet interface.....	77
7.3. Technical Service and on-line manuals.....	77
7.4. Saving and loading configurations.....	77
7.5. Screen capture.....	78
7.6. Status menu.....	78
7.7. SNMP.....	79
7.8. Remotely rebooting the equipment.....	80
8. TECHNICAL SPECIFICATIONS.....	81
9. A.E.Q. WARRANTY.....	82
APPENDIX A: GENERAL CHARACTERISTICS OF ENCODING MODES.....	83
APPENDIX B: PROTOCOLS ASSOCIATED WITH IP COMMUNICATIONS.....	85

B1. Circuit switching versus packet switching.	85
B1.1. Circuit switching.....	85
B1.1.1. Advantages:.....	85
B1.1.2. Disadvantages:.....	86
B1.2. Packet switching.....	86
B1.2.1. Switching modes.....	86
B1.2.2. Advantages:.....	86
B1.2.3. Disadvantages:.....	87
B2. IP protocol.....	87
B2.1. IP addressing.....	88
B2.2. Unicast vs. Multicast.....	88
B3. RTP protocol.....	89
B3.1. Default PHOENIX ALIO configuration.....	90
B4. SIP protocol.....	90
B4.1. Working modes.....	90
B4.2. Possible work scenarios.....	92
B4.3. PHOENIX ALIO default SIP configuration.....	92
B5. STUN protocol.....	93
APPENDIX C: PORTS USED BY PHOENIX EQUIPMENT.....	95
APPENDIX D: APPLICATION NOTES GUIDE.....	96
D1. Internet connection using standard cable access.....	96
D2. Special applications using different kinds of Internet physical accesses, or point to point connections.....	96
APPENDIX E: ADDITIONAL INFORMATION.....	97

1. INTRODUCTION.

1.1. General description.

AEQ PHOENIX ALIO is a stereo IP audiocodect for mobile applications. It is easy to configure and operate, and integrates a digital mixer with 4 analog inputs.

It features independent bass and treble control for each input, adapting the characteristics of each speaker's voice, or correcting the defects of external signals.

It has been specifically designed for sports reporting applications, but it has also been optimized to make it easy to use in the most varied scenarios, even musical events.

Its IP connectivity allows the user to choose among a wide variety of connection modes: dedicated networks, DSL, cable - modem, fiber optic, WiFi, Wig-MAX, Inmarsat satellite, etc. The application notes listed at the end of this manual provide information about how to operate the unit in each case. AN-5B stands out among them, describing a simple and effective way to connect the audiocodect to 3G and 4G networks, as well as to WiFi hotspots through a router and modem that can be provided by AEQ or obtained locally.

PHOENIX ALIO is optimized for OPUS encoding algorithms, but it is also compatible with other AEQ and third-party audiocodects, as it also features AEQ LD Extend modes and the mandatory algorithms according to EBU-TECH 3326 specification from EBU N/ACIP work group.

When connecting to another AEQ codect, users can take advantage of an exclusive set of tools that makes initiating communications and control of the unit a simple task:

- The "**SmartRTP**" proprietary call-initiation protocol that simplifies connection to compatible codects.
- "**AEQ ControlPHOENIX**", remote control Software that allows for the remote operation and adjustment of the unit from your station. ControlPhoenix allows you to control everything related to the call initiation process and also the adjustment of all audio parameters and the local audio routing of ALIO.
- "**HELP**" function, that allows the journalist to use the system to request for assistance from the station when facing an unexpected situation.

By default, PHOENIX ALIO offers a stereo or mono channel for the **program** signal with its corresponding return. A second bidirectional, mono or stereo channel for **coordination** or redundancy purposes can be activated by purchasing its **license** (that activation can be accomplished from "AEQ ControlPHOENIX" application and is detailed in section 6.4.7 of the application user's manual).

PHOENIX ALIO is powered from mains. Optionally, it can be equipped with an UPS that is mains-charged and can provide more than 120 minutes of autonomy, and can also feed a 3G/4G router – modem set and even charge mobile devices.

We recommend you reading this manual and "AEQ ControlPHOENIX" application user's manual carefully and completely before using the unit, although chapters 5 and 6 offer a quickstart user's guide.

1.2. Technical characteristics.

- 4 female XLR-3 microphone inputs. Low noise preamplifier and switchable Phantom power supply. 2 K Ω input impedance.
- 2 female XLR-3 line inputs, with 9 K Ω impedance, 0dBu, nominal level, max. 20 dBu.
- 2 male XLR-3 outputs. Output impedance: < 100 Ω , nominal level, 0dBu, max. 20 dBu.
- 2 - 1/4" Jack stereo headphone outputs, with volume control and TX/RX balance adjustment from front panel.

Communications interface:

- IP Ethernet port interface, RJ45 connector. The **default IP address** for PHOENIX ALIO is **192.168.1.88**.
- Two independent links can be established (when an optional 2nd channel is purchased) using the same interface.
- Satellite: an external satellite interface can be connected to the IP interface.
- 3G / 4G telephony: a 3G or 4G modem can be connected to the IP interface.
- Wireless data links: a "wireless bridge", WiMax or WiFi antenna can be connected to the IP interface.

Other features:

- Front user panel with keyboard and rotary encoders.
- OLED graphic display.
- 2 stereo LED VU-meters.
- Operating temperature range: -10 to +45 ° C (14 to 114 ° F).
- Dimensions: 242 x 210 x 60 mm (9.5 x 8.3 x 2.4 inches).
- Power supply: 15V DC (9 to 18V DC).
- Power consumption: 14W max.
- External adapter: universal 90-263V input.
- Optional UPS with 12V output for the audiocodec and two USB ports for router supply and/or mobile devices charging.

AEQ offers the "SmartRTP" call initiation protocol in order to greatly simplify the operation of the audiocodec.

AEQ also offers two SIP servers free of charge as a standard service for the users of Phoenix ALIO. One of them is configured as main and the other is provided as a backup. More information can be found in **Appendix B**.

1.3. Available encoding algorithms.

- **OPUS** with $F_s=48$ KHz, mono, stereo, with 4 mono and 3 stereo presets. Bit rates between 12 and 192 Kbps, very low delay and audio bandwidth between 6 and 20 KHz.
- **G711** A-law, u-law (64 Kbps, low delay, 3.5 KHz audio bandwidth).
- **G722** (64 Kbps, low delay, 7 KHz audio bandwidth).
- **AEQ-LD** with $F_s=16, 32$ or 48 KHz, mono or stereo. Available bit rates between 64 and 384 Kbps, audio bandwidth between 7 and 19 KHz.
- **MPEG 1 and 2 - LII**, with F_s between 16 and 48 KHz, mono, stereo, dual channel and Joint stereo. Binary bit rate between 64 and 384 Kbps. Audio bandwidth between 10.5 and 16.5 KHz.
- **PCM (linear)**: very low delay, transparent quality. $F_s=48$ or 32 KHz with 12, 16, 20 or 24 bits/sample, mono or stereo (bit rates between 576 and 2304 Kbps), audio bandwidth between 16 and 20 KHz.

Additional encoding modes can be considered according to each customer's specific needs, such as:

- **AAC-LC***:
 - Mode: Mono / stereo / MS stereo. Sampling frequency: 24 / 32 / 48 KHz
 - Bitrate: 32 / 64 / 96 / 128 / 192 / 256 Kbps
- **AAC-LD***:
 - Mode: Mono / stereo / MS stereo. Sampling frequency: 48 KHz
 - Bitrate: 32 / 64 / 96 / 128 / 192 / 256 Kbps

* Operation with two AAC simultaneously not supported.

Please contact AEQ Sales Department or authorized dealers for more information.

1.4. Block diagram.

1.4.1. Internal diagram.

The unit's internal design is organized in several functional modules that make Phoenix ALIO audiocodec a complete IP communications platform. The unit is provided with a professional quality analog audio input and output system and a versatile audio matrix with processing capabilities. A simplified view of the distribution of these modules into the equipment's motherboard is presented below, as well as a brief description of each module's functionality:

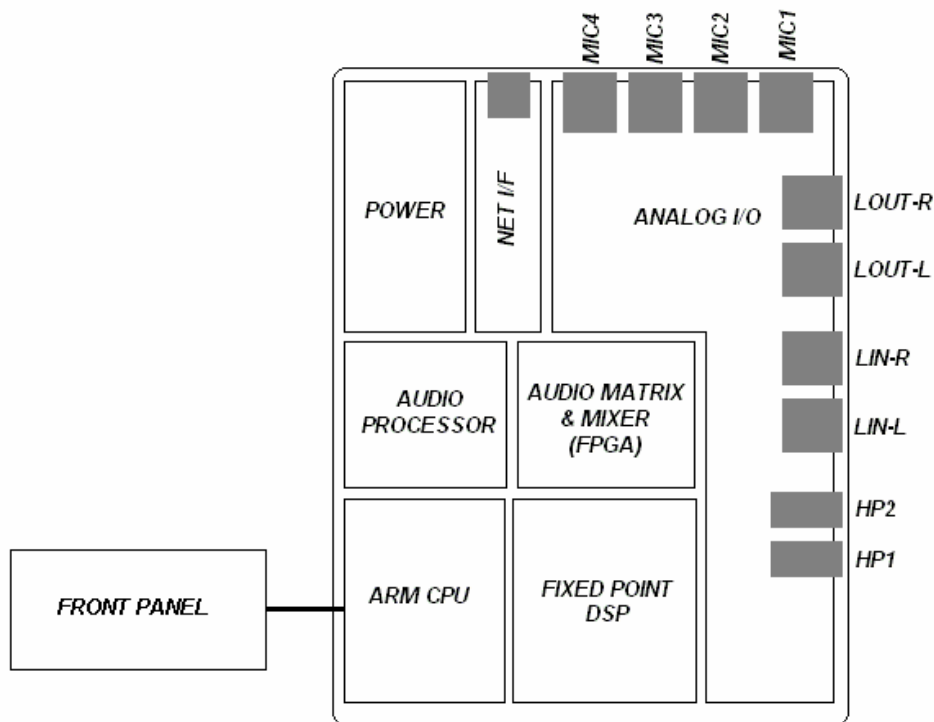

Internal Phoenix ALIO layout detail

- The audio part (ANALOG I/O) integrates 4 microphone preamplifiers featuring programmable digital gain as well as the line level balanced inputs and outputs together with two stereo headphone outputs able to drive both high and low impedance sets.
- The power supply section (POWER) converts the DC input (12V/1A) to the different DC voltages required inside the unit.
- The FRONT PANEL is connected to the CPU, and consists in an OLED display where the control and configuration menus are displayed, as well as a set of keys and indicators associated to the operation of the unit such as the alphanumeric keyboard, rotary encoders and four high-resolution LED vumeters.
- The CPU is a high-performance and low-power ARM processor in charge of several tasks such as the user interface, configuration of the other programmable elements (DSP, FPGA, audio processor, preamplifiers, etc.) and the management of IP communications, etc.
- The DSP (FIXED POINT DSP) is a high-performance fixed-point processor that carries out the encoding and decoding of up to two stereo channels using different compression algorithms and as later described in this manual.
- The audio matrix (AUDIO MATRIX & MIXER) is implemented using a new-generation low power FPGA, with 6 inputs + 2 stereo receiving buses / 6 outputs + 2 stereo transmitting buses. The FPGA can perform any crosspoints combination with great dynamic range and is controlled by the CPU. It also relies on a specialized co-processor (AUDIO PROCESSOR) that provides individual low and high frequency adjustment for each input.

- The network interface (NET I/F) is an Ethernet 10/100 Mbps interface that allows for both audio transmission / reception and remote control of the unit through a single port. The functionality of this port can also be for the connection of standard equipment to access Wi-Fi, 3G/4G and satellite networks as described in specific application notes available on AEQ's website aeq.eu or aeqbroadcast.com.

1.4.2. Audio matrix.

The different audio sources are first converted to digital format (24 bits / 48 KHz sampling rate) to be processed by a digital audio matrix. Once the outputs are obtained, they are converted back to analog format:

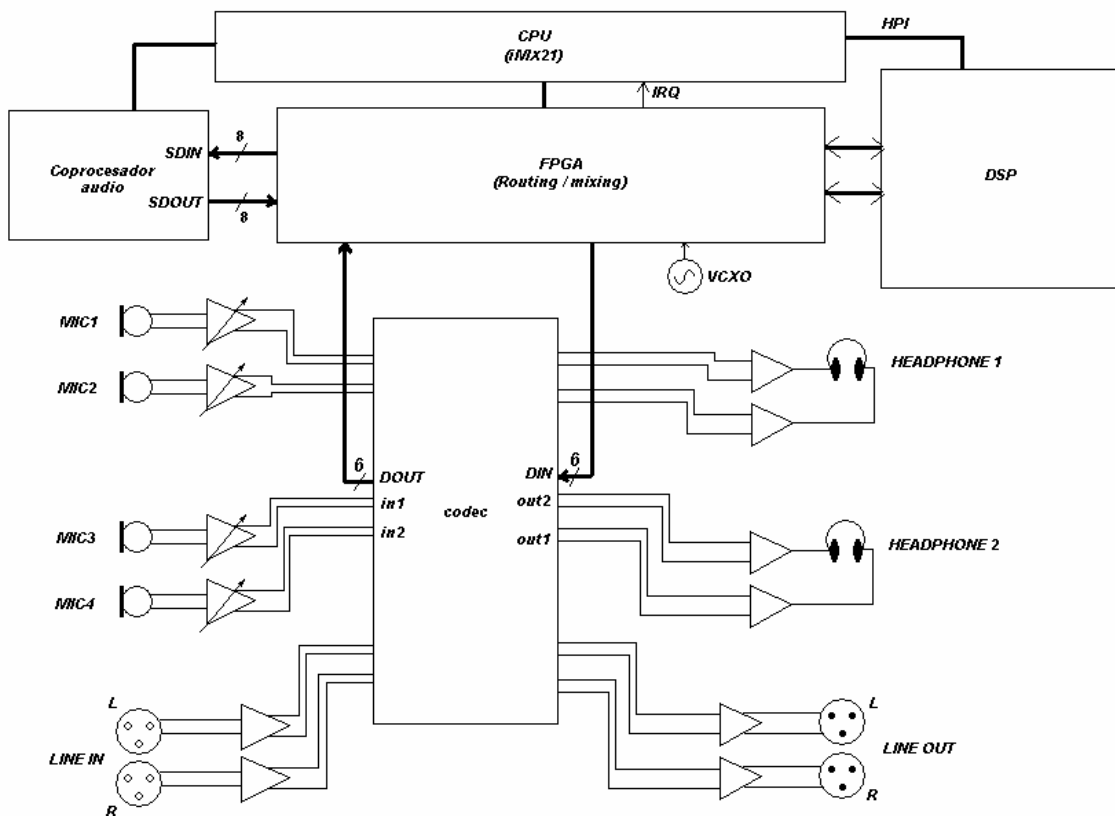

Audio inputs/outputs structure

The following figure shows the internal buses for transmission, reception and CUE of both communications channels that are calculated in the audio matrix, so the user can better understand what can be done with the different audio sources and what can be listened at the different outputs.

As can be seen, each input (4 microphones or 3 microphones + LINE IN) can be routed to any of the transmit buses (program or coordination) or to CUE pre-listen bus. At the same time, we can select what to listen at any of the outputs (LINE OUT + 2 stereo headphones), Program or Coordination buses (choosing the mix level between send and return directions) or the local CUE pre-listen bus.

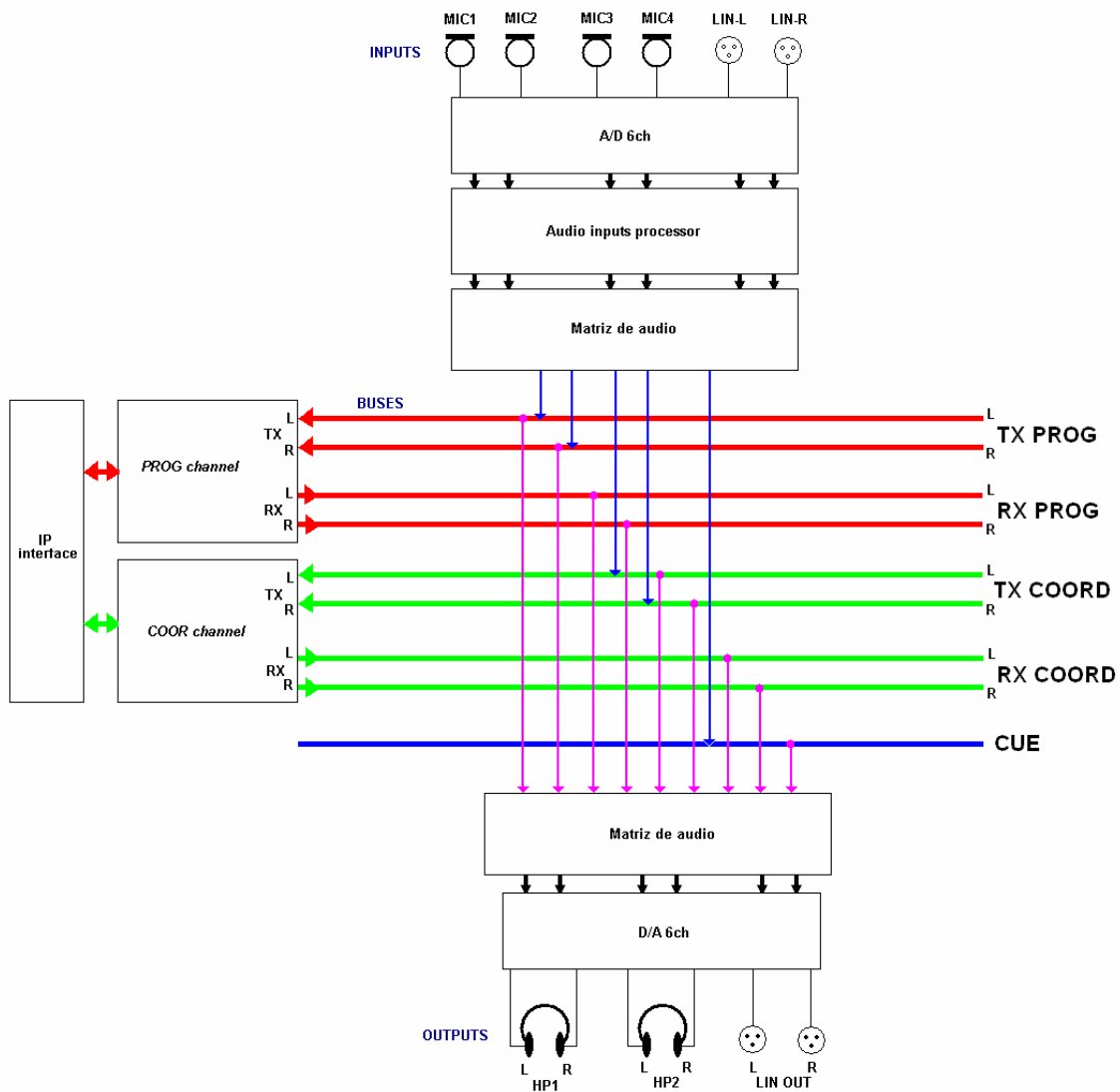

Audio matrix structure

The assignment of mono and stereo signals is performed automatically (for example, if MIC 2 is routed to the transmit bus of a channel where a stereo coding algorithm has been selected, the unit will make a crosspoint to both L and R. However, if the line input is sent to a mono channel, a crosspoint creating a L + R sum (attenuated by 6dB) will be accomplished. Just in the same way, if we want to listen to a mono-encoded channel in the headphones, the signal will be routed to both sides.

The send buses are accessed through back-lit keys and their colour also denotes to what SEND-bus the corresponding audio input routed (RED=Program, GREEN=Coordination, off=CUE). The same colour convention is used for the outputs. The user can select what bus to monitor by simply pressing on the corresponding rotary encoder. The control of the listening level is done with the associated rotary encoder and is also visible through level bars on the OLED display. TX / RX mixing level is controlled with potentiometers associated to each output.

1.5. Compatibility with other AEQ codecs.

PHOENIX ALIO offers the possibility to connect to other AEQ codecs.

It is compatible with AEQ TALENT, Phoenix MERCURY, STUDIO, VENUS, VENUS V2, VENUS V3, VENUS V4, VENUS V4+, STRATOS and MOBILE.

The "**SmartRTP**" mode and **OPUS** encoding algorithm can be used with AEQ TALENT, Phoenix MERCURY, STUDIO, VENUS, VENUS V2, VENUS V3, VENUS V4, VENUS V4+ and STRATOS updated to latest CPU firmware versions.

1.6. Compatibility with third-party codecs.

PHOENIX ALIO is a portable IP audiocodec compatible with EBU-TECH 3326 technical specification from EBU N/ACIP workgroup. This technical specification was developed to guarantee compatibility between equipment from different manufacturers in applications for professional-quality audio contribution over IP networks. Therefore it is possible to connect PHOENIX ALIO with any codec from other manufacturer over IP provided that this unit has been developed according to N/ACIP (please check third-party codecs technical specifications).

2. PHYSICAL DESCRIPTION OF THE UNIT.

Before anything else, it is necessary to become familiar with the connectors and other elements present in the back, right and front panels of the unit in order to understand the wiring and installation required for the PHOENIX ALIO.

2.1. Description of the right panel and connections.

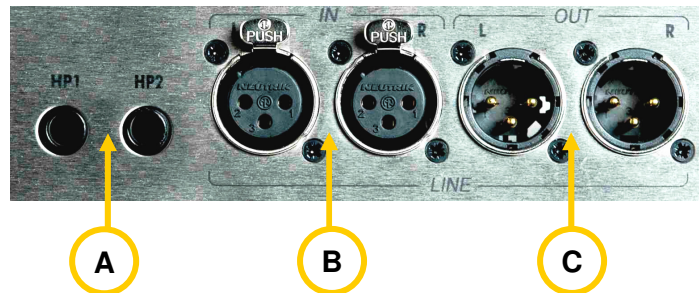

2.1.1. Headphone 1 and 2 outputs ("HP1" y "HP2"). **A**

1/4" Headphone Jack. Unbalanced connection.

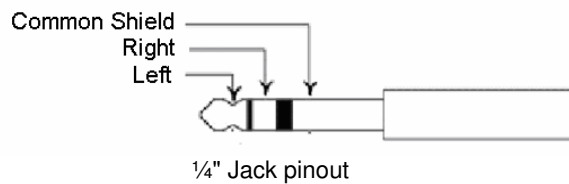

2.1.2. Line inputs ("LINE IN"). **B**

XLR-3 female connector. Balanced connection.

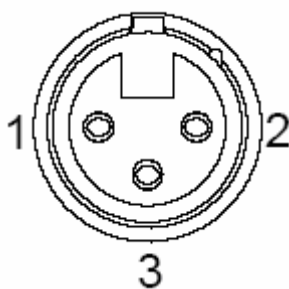

L input - Female

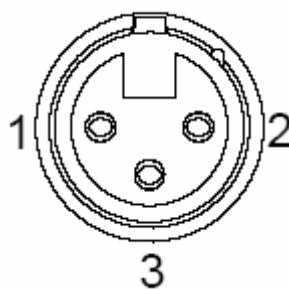

R input - Female

(Connectors as seen from the soldered side)

XLR-3 pinout

- Pin 1 → Ground
- Pin 2 → + Input
- Pin 3 → - Input

2.1.3. Line outputs ("LINE OUT"). C

XLR-3 Male connector. Balanced connection.

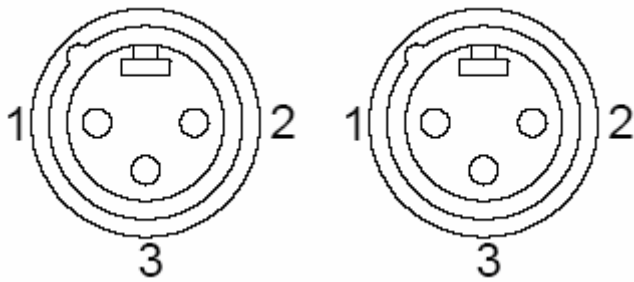

(Connector as seen by the soldered side)

L output - Male

R output - Male

XLR-3 pinout

- Pin 1 → Ground
- Pin 2 → + Output
- Pin 3 → - Output

IMPORTANT NOTE: If you want to connect any of the outputs to an unbalanced input, you must unbalance the output, using the corresponding positive and GND (ground) pins and leaving the negative pin unconnected. Also keep in mind that unbalancing the output will reduce its level by 6dB.

2.2. Description of the back panel and connections.

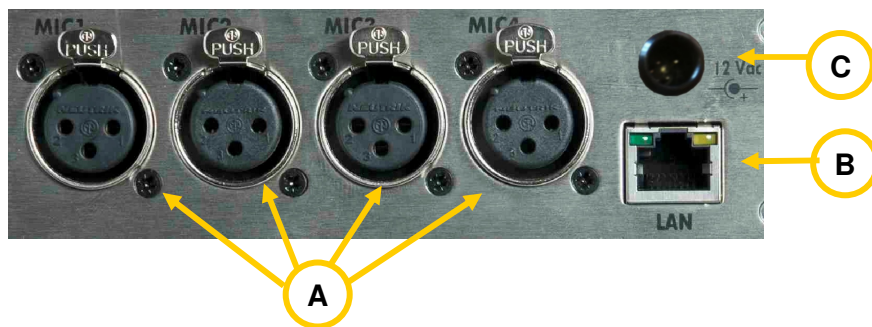

2.2.1. Microphone inputs ("MIC1", "MIC2", "MIC3" and "MIC4"). A

XLR-3 female connector. Balanced connection.

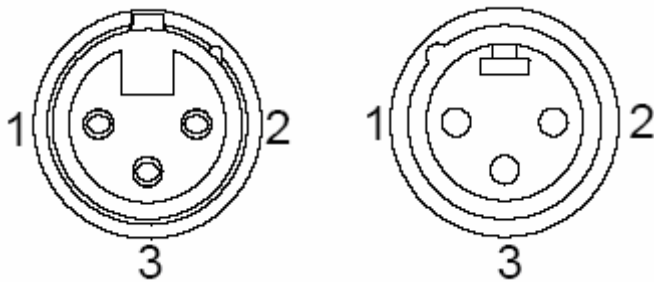

(Connector as seen by the soldered side)

Input - Female

Male plug - cable

XLR-3 pinout

- Pin 1 → Ground
- Pin 2 → + Input
- Pin 3 → - Input

All microphone inputs (MIC1, MIC2, MIC3 and MIC4) feature low-noise preamplifiers and are able to provide Phantom supply (+12 V DC / 10 mA). These can be enabled from each input's menu (see section 3.5), in order to offer compatibility with both dynamic or condenser microphones. The range of the preamplifier gain is wide range (0 to 65dB) making it suitable for a large range of microphone models available on the market.

2.2.2. Ethernet port. **B**

PHOENIX ALIO features one Ethernet port. Using this port, the unit can be connected to a LAN or WAN network and send / receive audio over IP. This port is also used to configure and administrate the unit from one or more computers using the remote control software. The **default IP address** for PHOENIX ALIO is **192.168.1.88**.

Please refer to "AEQ ControlPHOENIX" application manual.

The connector is a standard RJ45 10/100 BT, type, with the following pin assignment:

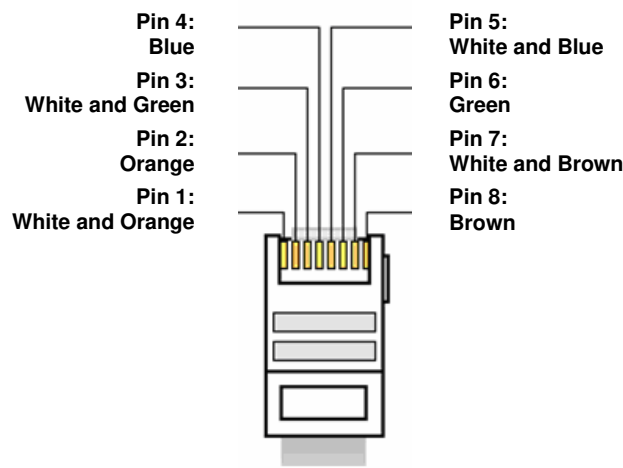

RJ45 connector pinout

2.2.3. Power supply. **C**

PHOENIX ALIO can be powered by an external, specifically designed 15V DC (or 12V DC) power supply. The unit can be connected to the provided charger either directly or using an optional UPS in cascade. It cannot be connected directly to a vehicle battery without connecting the mentioned optional UPS or an equivalent voltage stabilizer.

The power cable termination is fitted with a special connector featuring a locking mechanism to prevent accidental disconnections. Depending on the unit edition, the power connector may be different: the power supply provided with the unit will always include the right connector.

2.2.3.1. Using an external powerbank as an UPS.

An external, small and portable battery has been homologated as an optional accessory to Phoenix ALIO. It can operate as an UPS and also provide a certain degree of portability to the unit, as it can provide supply for full operation during about 4 hours when fully charged.



The recommended model is **XT-16000QC2** from **XT Power**.

In order to use this powerbank as an UPS, a specifically designed adapter must be used. This adapter can be purchased from AEQ and allows for charging of the battery at the same time as the PHOENIX ALIO gets power using the same AC/DC power adapter supplied with the unit (**15V DC**). In case that a mains cut happens, no operation interruption will be produced as long as the battery has enough charge.

IMPORTANT NOTE: Depending on the unit edition, there are 2 editions of the adapter where both the connector that goes to the unit (**1**) and the one that goes to the power supply (**2**) are different:

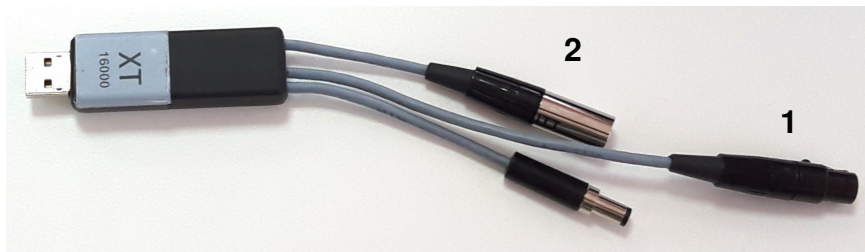

The way to connect it is as follows:





Configure the powerbank's output voltage to 12V by means of its lateral key and check this configuration in its display, where also the percentage of charge and the current charge status are displayed. If it is deeply discharged, please provide charge for some minutes without ALIO connected until at least a 10% percentage of charge is displayed.

This device also features additional USB ports. One of them remains free even when using AEQ UPS adapter, and can be used to charge phones (producing a logical reduction in the duration of the battery) or to power an external 4G modem-router. Please check application note AN-5 for more details.

NOTE: If this powerbank is purchased locally, please contact AEQ to obtain the special UPS adapter for ALIO.

IMPORTANT NOTE: There is another homologated powerbank model (**MP-10000**, also from XT Power) with a different adapter associated and that requires to use the **12V DC** power supply of PHOENIX ALIO. Please make sure that you're using the right combination of powerbank, adapter and power supply. In case of doubt, please consult AEQ Technical Service (support@aeq.es).



CAUTION: Due to risk of fire or explosion, avoid exposure of the powerbank to shocks, temperatures above 45°C, liquid pouring, etc.
The unit should be opened **ONLY** by qualified personnel.
(Please read the manufacturer's recommendations for more details)

3. USER INTERFACE DESCRIPTION. MANUAL CONTROL.

Configuration and operation of the Phoenix ALIO unit can be done either using the equipment front panel controls featuring an OLED screen and associated controls and indicators, or **remotely** using the "AEQ ControlPHOENIX" application (Control and Configuration software for AEQ TALENT, Phoenix ALIO, STRATOS, STUDIO, MERCURY, VENUS, VENUS V2, VENUS V3, VENUS V4 and VENUS V4+ audiocodescs). This chapter describes the first mode.

Functional areas or sections of the user interface are described next:

CONTROL SURFACE

The control surface has been designed bearing in mind that, quite often, it is not possible to send a qualified technician to accomplish an outside broadcast. It can be totally controlled from the station, and also locally operated by choosing among several simple options, that are further simplified when connected to another AEQ Phoenix audiocodec. A more detailed configuration can be carried out by setting up the parameters under the MENU key.

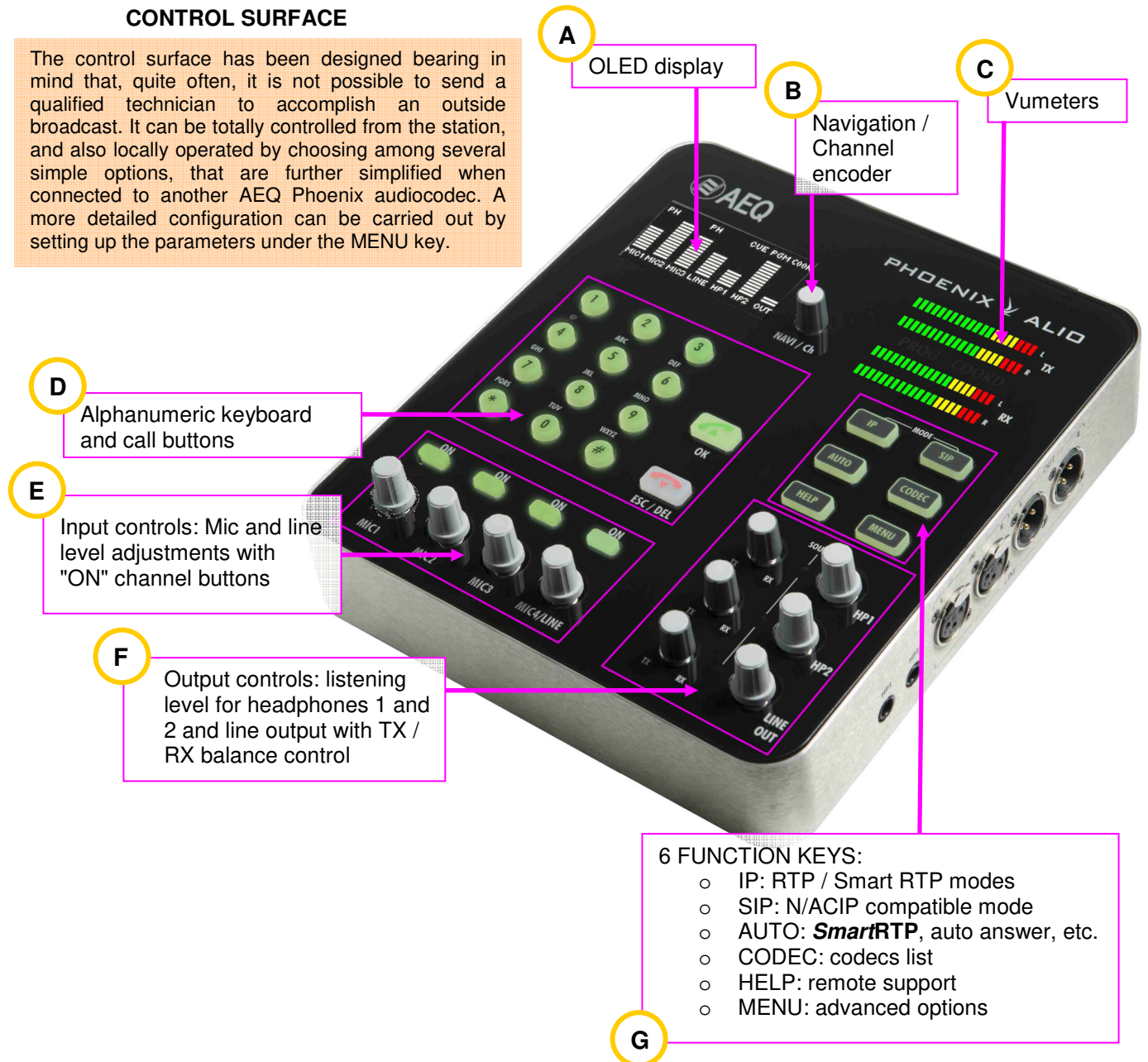

USER INTERFACE LOCK: From CPU version **6.80**, it is possible to **lock** certain functions of the user panel from the control software. These functions are disabled in groups and, this way, improper operation of the unit by users with little experience can be avoided. In order to get more details about which functions can be locked, check section 4.9 of this manual.

3.1. OLED Screen. A

High-contrast OLED screen with wide viewing angle and 128 x 64 pixels resolution in yellow and black. Depending on the screen model mounted on the unit, there may be small esthetic differences in some menus, although the functionality remains the same.

When Phoenix ALIO is powered-up, after a delay of approx. 15 seconds (that doesn't indicate any malfunction in the unit), two welcome screens will appear sequentially; the first one shows AEQ logo and the second one displays the audiocodec model:

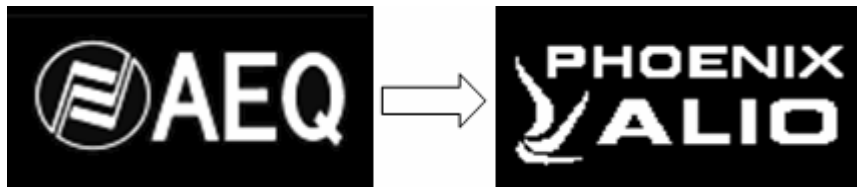

Detail of welcome screens

After a while, the display changes to show the MAIN STATUS screen, where the configuration of the different inputs and outputs is presented:

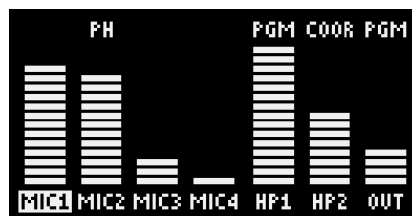

Detail of MAIN STATUS screen

This screen is divided in 7 columns. From left to right, the first 4 correspond to the 4 active inputs. The first three ones are always MIC1, MIC2 and MIC3. The fourth can correspond to MIC4 or LINE IN. This can be selected through the MIC4/LINE menu or through the "#" shortcut key in the numeric keyboard (the label under the level bar will change accordingly between "MIC4" and "LINE"). Finally, the three last columns correspond to the outputs (HP1, HP2 and OUT, as indicated under each level bar).

Each bar represents a relative mix level or output volume.

Each MIC input can also display a "PH" legend above the level bar, indicating that the input has its corresponding 12V Phantom power supply activated.

Also, the input names can appear highlighted as MIC1 in the above example screen. This indicates that a process (equalization) is applied to the input signal or that a value different to center is selected for the panorama/balance control.

Above each output level bar there is a label showing "PGM", "COOR" or "CUE". These are indicating what program bus is being monitored on each of the outputs. The label "MIX" is displayed when, while distribution mode is active, the PROG+COORD sending is activated.

This display can also display the different operation and configuration menus that are accessed and browsed through the navigation ("NAVI / Ch") rotary encoder and the rest of keys and encoders. Details will be provided later on in this chapter. The display also provides detailed information about active calls, if any. In case that any function of the user interface is locked and you try to access to this function, the display will show the "LOCKED - ACTION DISABLED" indication for a few seconds (see section 4.9 of this manual).

To save power and if the unit is "idle", the intensity of the display is dimmed after a while; normal brightness will be immediately recovered when any control is touched.

3.2. Navigation / Channel encoder ("NAVI / Ch"). B

This rotary encoder allows the user to browse through the different menus of the OLED multifunction screen. Turning it changes the selection among the options presented, moving the highlighting up and down. When the encoder is turned clockwise, the option selected is moved down, and turning it anti-clockwise, the option selected is moved up.



Pressing its button is equivalent to ENTER, validating the highlighted selection at that moment.

This rotary encoder has a second use. If the second optional channel (coordination COORD) is activated and no menu is being presented on the display, pressing the encoder will make the user interface change between PGM and COORD.

The modification of any of the parameters pertaining to the selected channel does not affect the selected operation of the other channel; if we are modifying the configuration for program (PROG), the status for coordination (COORD) will remain the same, with its communication, operating modes, etc. unaltered.

The active channel is clearly indicated by the "PROG" and "COORD" labels located between the vumeters. When a call or communication is established in the channel that is not active, the label will blink while the other remains steadily lit.

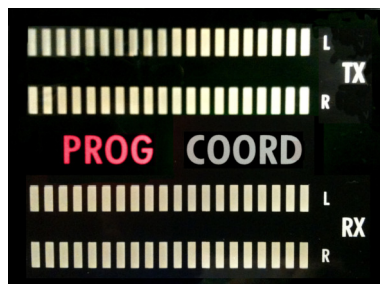

3.3. Vumeters. C

The unit is equipped with two stereo vumeters. From above, the first one is indicating the level of the TX signal. The second indicates the level of reception, RX. If the unit has the second optional coordination channel activated the vu meters will follow the "NAVI / Ch" encoder and will display the levels corresponding to the active channel and with the labels "PROG" and "COORD" between the vumeters and as explained above.

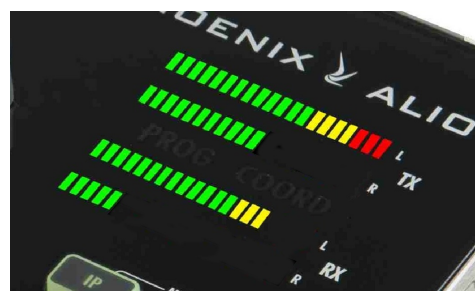

Each of the 4 vumeters consists in 2 bars of 20 LEDs each. From right to left, the three first LEDs are red followed by four orange coloured ones. The remainders of the LEDs are green. The scale applied has higher resolution around the transition between green and yellow colors.

Please note that the presence of audio is denoted at -36 dBV when the first green LED is illuminated. Transition from green to yellow is at 0 dBV, from yellow to red is at +7 dBV and, when all 3 red LEDs are on, displayed level corresponds to +13 dBV or higher.

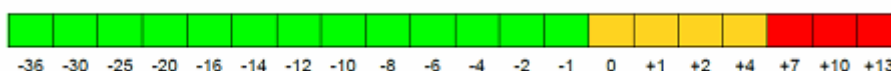

3.4. Alphanumeric keyboard and call buttons. D

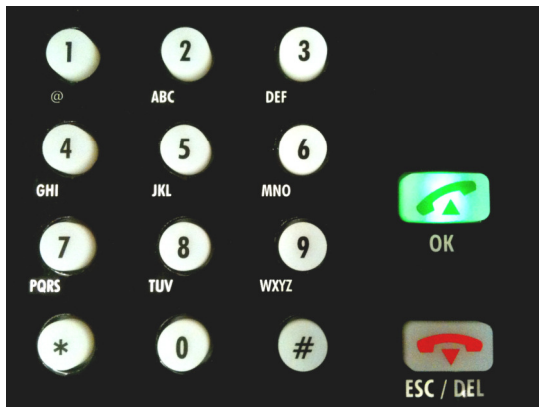

Standard numeric keyboard with 12 keys that, among many other functions, allows the user to dial IP addresses and port numbers in when calling in RTP mode, or to type letters and symbols when in SIP (Session Initiation Protocol) mode.

It can also be used to type text: just press each key repeatedly to switch between the different letters available for the same key, just like you would do to type an SMS on a mobile phone.

Depending on the status, the "OK" key (with a green telephone) allows the user to initiate a call or accept an option within a menu. On the other hand, the "ESC / DEL" key (with a red telephone) can hang up a communication, delete or go back in a menu (it will also light in red for around 15 seconds when the unit is turned on, until the welcome screens appear).

When the "OK" key is pressed from the idle screen to make a call, the alphanumeric keyboard gets illuminated in red when the call is to be made in PROG, or in green when the current channel is COORD.

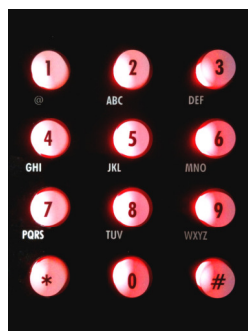

Dialing in PROG



Dialing in COORD

The keys are illuminated laterally; this way it is possible to determine whether the channel is PROG or COORD even by colour-blind people

NOTE: The * key shifts between capitals, lower case and numbers. When you are typing, keys 1 and # allows you to enter special characters (@ and ". among them) and key 0 can generate number "0" or spaces.

The # key is also a shortcut to switch between MIC4 and LINE (provided that we are not typing into a text menu).

3.5. Inputs control. E

Each input has an associated rotary encoder with pushbutton and an activation/routing key (ON). If the rotary encoder is turned, the mix gain to the selected bus is altered for that input, between mute (-infinity) and +18 dB. The level bar at the display shows an indication of this level.



The ON buttons allow the user to select which bus the associated input will be sent to. When it is off, pressing it will turn the button RED-illuminated, indicating that the input is sent to PROGRAM transmission channel. One more pressing and the key will be illuminated in GREEN, indicating that the channel is sent to COORDINATION transmission. If it is pressed once again, it will be off again, and the input will only be available locally in the CUE pre-listen bus.

The selection is cyclic for each input:

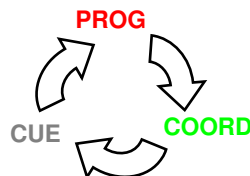

When several inputs have their ON button illuminated in the same colour, they will be mixed (each source according to the selected mix level) to the selected bus (PROG, COORD or CUE).

IMPORTANT NOTE: There is an alternative working mode in which those inputs are sent in a different way. Instead of that cyclic PROG - COORD - CUE selection, it goes to a cyclic PROG - CUE - PROG or COORD - CUE - COORD selection, switching from one to the other by a long press of the ON button when it's off. You can switch to that mode by activating the "LONG-PRESS SWAP" option in the "SPECIAL FEATURES" submenu. See section 3.7.5.5 of this manual.

If additionally the "ALLOW PRG+CRD" option is activated, the distribution mode (MIX) is implemented, in which the cyclical selection becomes PROG - CUE - PROG, COORD - CUE - COORD or PROG+COORD - CUE - PROG+COORD (you can also switch from one to another by a long press of the ON button when it's off). When the PROG+COORD (MIX) send is activated, the ON button lights up in red and green at the same time.

When the encoder button is pressed, access to the associated input's configuration menu is provided. Here the user can configure the corresponding gain, equalization (bass/treble), activation of the 12V Phantom supply and panorama control. In the case of MIC4 / LINE input, the user will also be able to select which input is used (microphone 4 or the line input at the right panel); when working in line mode, panorama control changes to balance control.

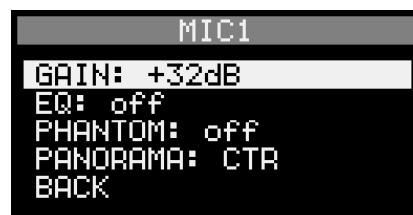

WARNING: DO NOT turn Phantom power on or off for a microphone unless the Microphone Gain is set to minimum. Depending on the microphone model and its specifications, the negative of observing this procedure may result in very high level and high pitched noise that could be routed to the units communication buses and the headphone outputs.

The corresponding input encoder can be used to navigate within the menu, or alternatively, the "NAVI / Ch" rotary encoder can also be used. The "BACK" option in each menu or the "ESC / DEL" key can be used to cancel and go back.

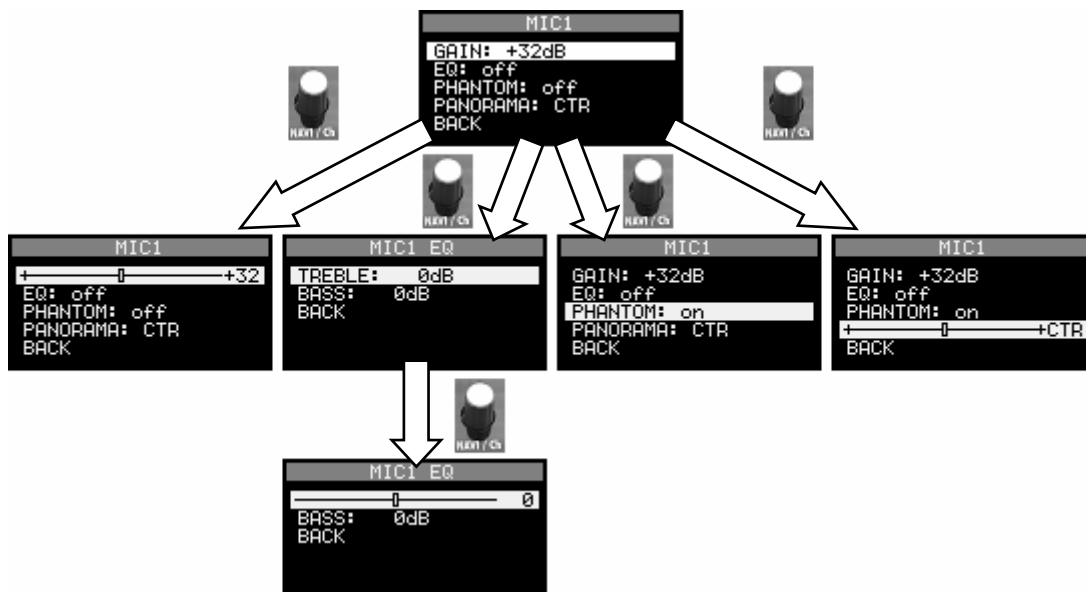

The "EQ" indication in the main screen (input name highlighted) will become active whenever a value different to 0 dB is selected for either the bass or treble controls, as previously explained. The same happens (input name highlighted) when a value different to center is selected for the panorama/balance control; the panorama/balance setting is temporary: it returns to its center value when you restart the unit.

As previously indicated, The "MIC4/LINE" input menu is slightly different, as there is an additional option to select between MIC4 and LINE IN. In the following image, the selected input is the line one, so the Phantom option becomes unavailable and "BALANCE" appears instead of "PANORAMA":

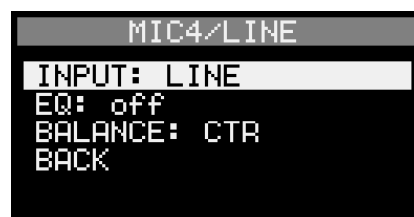

NOTE: When browsing an input menu, the user can quickly change to configure another input by simply pressing the corresponding encoder button. From now on, the modifications made correspond to the newly selected input.

3.6. Outputs control. **F**

The unit has 3 stereo outputs: 2 for headphones, able to drive both high and low impedance models with 1/4" TRS or jack connectors and 1 balanced line output with 2 male XLR connectors. All of them are located in the right panel of the unit.

Each output has a labelled control section ("HP1", "HP2" and "LINE OUT"), located at the bottom right area of the front panel.

TX / RX level balance potentiometer: Allows the user to continuously adjust which ratio of the corresponding output comes from the channel local transmission (TX, send) and what from the same channel reception (reception, RX). When in the central position, equal levels of RX and TX will be listened to, both with 6dB attenuation.

Output level encoder: Adjusts the listening level of the corresponding output. It will be displayed on the OLED with level bars.

Pressing the **output level encoder button** cyclically selects the source bus for that output bus, between CUE (SOURCE LED off), PROG (SOURCE LED illuminated red) or COORD (SOURCE LED illuminated green). The display will show a label above the corresponding level bar:

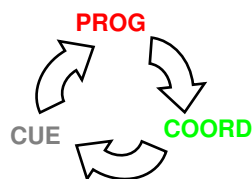

IMPORTANT NOTE: There is an alternative working mode in which the sending of audio to those outputs is done in a different way. Instead of that cyclic PROG - COORD - CUE sending, it goes to a cyclic PROG - CUE - PROG or COORD - CUE - COORD sending, switching from one to the other by a long press of the encoder button when the associated LED is off. You can switch to that mode by activating the "LONG-PRESS SWAP" option in the "SPECIAL FEATURES" submenu. See section 3.7.5.5 of this manual.

If additionally the option "ALLOW PRG+CRD" is activated, the distribution mode (MIX) is implemented, in which the cyclical sending becomes PROG - CUE - PROG, COORD - CUE - COORD or PROG+COORD - CUE - PROG+COORD (you can also switch from one to another by a long press of the encoder button when the associated LED is off). When the PROG+COORD (MIX) sending is activated, the LED besides the encoder lights up in amber and the label "MIX" is displayed above the output level bar: in this case, you can hear PROGRAM on the left side and COORDINATION on the right. In this case, the balance between send (TX) and reception (RX) for that output is applied on both channels.



In the main screen, the display will show the level and source selected for each output.

Operation is the same for the potentiometers, encoders, SOURCE LEDs and main display for all HP1, HP2 and LINE OUT outputs.

NOTE: Adjust the volume with caution; excessive listening levels can damage your hearing.

3.7. Function keys. G

The units operational keys are completed by 6 illuminated function keys located at the right area of ALIO front panel. Some of these keys ("IP", "SIP", "AUTO", "CODEC") configure parameters or operating modes for the currently active channel only. "HELP" and "MENU" keys are associated to functions that are common for the unit.

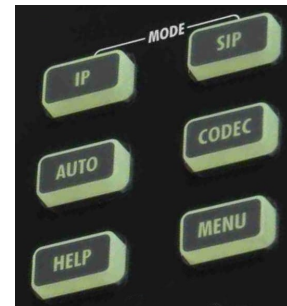

The detailed description of the function for each key is described below.

3.7.1. MODE keys ("IP" and "SIP").

These keys are labelled as "IP" and "SIP" and their operation are exclusive (only one of these can be enabled at any given time). These keys affect the currently selected channel only (PROG or COORD and provided licensed). They allow the user to communicate with other



select how Phoenix ALIO equipment.

IP mode: RTP / SmartRTP

When the "IP" key is pressed, the unit will establish all communications in RTP mode, without using SIP. In order to establish a communication in this mode, the destination IP address must be known as well as the receiving audio port.

The standard operation, compatible with other manufacturers, requires that both sides of the communication initiate the call (call the IP and the active audio port of the remote equipment) and that both have selected the same encoding algorithm for the communication.

However, thanks to the "**SmartRTP**" functionality from **AEQ**, the task of making an RTP call is greatly simplified. When operating Phoenix family of AudioCodecs with this mode activated, it is only required that the "caller" launches the call. The remote equipment will automatically answer and send its audio stream to the callers IP and port. Further, the AudioCodec will also detect and automatically select the encoding algorithm that the calling unit is using to initiate the communication. The call does not need to be manually accepted and the hang-up event (from any end) will also be signaled to either unit.

NOTE: The illumination of the key will flash whenever the associated channel is unavailable because the Ethernet link is down or because there is no IP configuration after activating DHCP option. Once the flashing of the key stops, communications can be initiated.

Please refer to chapters 3.7.2, 4.2.1 and 5.3.1 for more details.

SIP mode: N/ACIP compatible

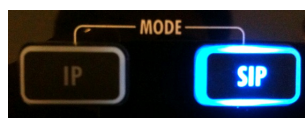

SIP (Session Initiation Protocol) is an alternative to RTP for making a call. The SIP key configures the unit so all communications made with the currently active channels use this signaling protocol, compatible with other codecs following N/ACIP standard from EBU. It can be used directly between audiocoders (DIRECT SIP) or taking advantage of an external Proxy (PROXY SIP). Its function is to maintain a database of all registered codecs with their IP addresses and listening ports making it possible to establish a connection between audiocoders located in different networks. This allows the user to "forget" about the IP address and port of the remote unit.

SIP mode will alternatively change between DIRECT SIP and PROXY SIP when pressing the "SIP" key repeatedly. Depending on the selected mode, the communications menu options (MENU→COMMUNICATIONS→SIP) may vary slightly so the user only needs to configure the required options.

NOTE: Calls cannot be made when the illumination of the key is flashing. This is indicating that the Ethernet link is down, that there is no IP configuration after activating DHCP option or that there are issues with the registration process with a SIP server (when in PROXY SIP mode). Communications can be established once the key stops flashing.

Please read chapters 4.2.2, 4.2.3, 5.3.2 and 5.3.3 for more details.

3.7.2. "AUTO" key.

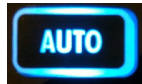

This key opens a menu where several automation options are available that simplifies the operation of the unit and automatic call management. The adjustments made and displayed apply to the currently active channel only.

The "AUTO" button will be illuminated whenever at least one of the options is activated.

3.7.2.1. *SmartRTP* / *AutoAnswer*.

First, we can select whether to activate or not the "**SmartRTP**" function (available only in RTP mode), that allows, as explained before, to signal call establishment and hang up from a single end of the call without using higher level negotiation protocols such as SIP.

When the operating mode for the currently selected channel has been set to SIP, this option is substituted by "**Autoanswer**", which makes the unit automatically accept the incoming calls. On the contrary and if in manual answer mode, incoming calls are signaled on the screen and the user must press the "OK" key to accept them or the "ESC / DEL" key to reject them.

3.7.2.2. *Auto Hang-Up*.

Next, the "Auto Hang-Up" option is available in the "AUTO" menu. This option makes the unit hang up a call whenever the incoming stream can't be synchronized (either because it is not received, in this case the call status will be "CONNECTED - NO DATA", or because some incoming packets are damaged or lost, or because the encoding algorithm is not the one expected. In this case, the call status will be "CONNECTED - NO SYNC"). In both cases, the call will be disconnected or hung up once the set out time for synchronization has been completed - timeout.

This is useful and avoids leaving a unit busy indefinitely or when it is needed to force re-dialling from the other end (in SIP mode).

3.7.2.3. *Permanent call*.

This option configures the unit so that it automatically does what is necessary to maintain the active connection even after temporary line drops or power outages. It is recommended that this option is activated in one of the communicating codecs only, except when using RTP with "**SmartRTP**" mode deactivated. In this case, this option must be enabled at both sides to guarantee the operational efficiency.

3.7.3. "CODEC" key.



This key allows the selection of:

- A encoding algorithm, among those supported by the unit, for RTP calls
- A encoding profile (list of prioritized preferred modes, used when negotiating calls with other units), for SIP calls.

The same way as the other function keys (except "HELP" and "MENU"), the selection is accomplished for the currently active channel: PROG or COORD (the latter only if license is activated).

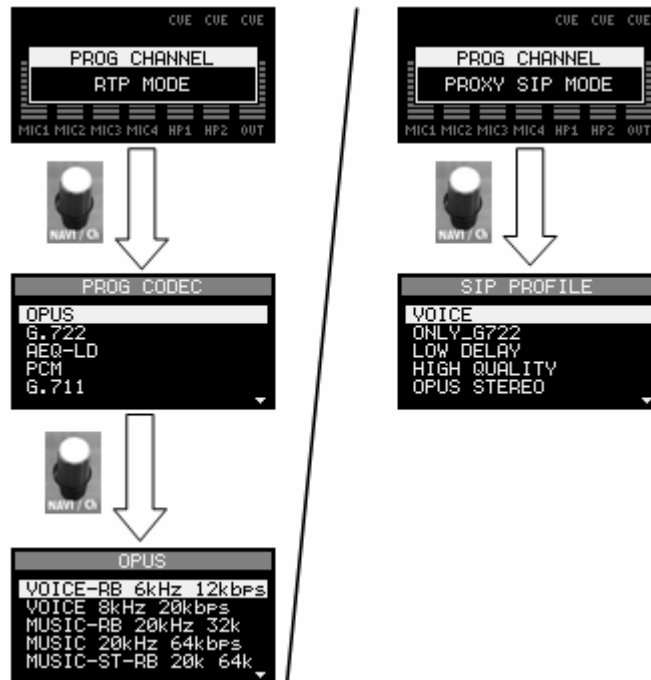

As can be noticed in the above sequence of screen captures, when in RTP mode the encoding algorithms are presented grouped by families (OPUS, G.722, AEQ-LD, PCM, G.711, etc), and several particular modes are available within each family (A/u law, mono, stereo, different bitrates, sampling frequencies, etc). When a particular mode is selected, successive calls will be made using that algorithm, and the remote codec must be configured just in the same way, unless "**SmartRTP**" mode is activated: in this case, the encoding algorithm will be automatically notified to the remote audiocodec.

In SIP mode, however, a list of encoding profiles is presented. Each profile is basically a list with a name, including one or more precise encoding algorithms, and in order of preference. When a unit calls another in SIP mode, it proposes this list, and the first one supported by both audiocodecs will be the one finally adopted.

Management of the existing profiles can only be done by the control software and they remain stored in the unit. The profiles are stored in the non-volatile part of the ALIO's memory. From the front panel of the ALIO the user can only select among a list of stored profiles.

When the user press and hold the "CODEC" key for more than 1 second, an informative screen will show up describing the currently selected codec or profile for the active channel, without making any modifications to it. Whenever a SIP call is established, the indicated codec will be the one that is actually used.

3.7.4. "HELP" key.



This key, that is independent on the active channel, is not following the active channel and it sends a notification to the remote control software provided that this is in use. This way, a Phoenix ALIO user that requires assistance or has doubts can ask the operator that is remotely controlling or monitoring the unit with the "AEQ ControlPHOENIX" software for help.

When the "HELP" key is pressed, a notification will appear on the OLED screen of the ALIO and the key will start to flash in red. On the remote control software a pop-up notification will appear asking the operator to get in touch with the ALIO user.

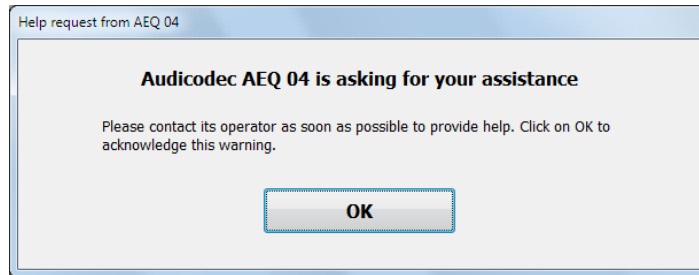

Once this notification is confirmed by the remote operator, the ALIO's "HELP" key will stop flashing and the user will be notified through the OLED display that the remote operator has acknowledged the call for assistance:



The notification can be cancelled at any moment by pressing the "HELP" key again:



3.7.5. "MENU" key.

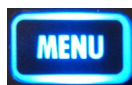

This key is not following the active channel and provides access to the configuration menu of the ALIO. This menu also contains more advanced or less frequently used options such as access to presets, Phoenix ALIO IP configuration, communications parameters (RTP, SIP and NAT parameters), test options (loops, tones, etc.) or maintenance operations (firmware version, time/date adjustment, system reboot, buzzer).



3.7.5.1. "PRESETS" submenu.

The first available option is "PRESETS". By entering this submenu (pressing on the encoder button when the option is highlighted), we can access to the presets list previously defined in the "AEQ ControlPHOENIX" application (see section 5.1.8 of the application user's manual):



By turning and pressing the encoder it's possible to select and load any of the presets of the list. Then the following message appears:



You can also access the list of presets and activate any of them from the "AEQ ControlPHOENIX" application (see section 5.1.8.5 of the application user's manual).

When any of the defined presets has been loaded from the equipment or from the application, the last loaded preset is indicated in the list with a > symbol in front of it, as follows:



If any subsequent change is made to the equipment in at least one of the parameters configured by the last loaded preset, it's indicated in the list with the ! symbol as follows:



3.7.5.2. "ETHERNET" submenu.

The next available option is "ETHERNET" configuration. By entering this submenu (pressing on the encoder button when the option is highlighted), we can access the IP configuration of the unit, where we can specify whether it gets the configuration automatically (DHCP ON, requires a DHCP server active in the local network). When there is no connection to the DHCP server or the IP configuration process fails the active MODE key ("IP" or "SIP") will flash in order to indicate it (see section 3.7.1).

```

ETHERNET
DHCP: off
IP: 192.168.1.88
BACK
  
```

If DHCP is not used, we need to select the second line in this list and where the current IP address is shown. Click on the rotary encoder and this will open all the available fields for the correct IP configuration of the ALIO and allows the user to change the settings for the IP address, mask, gateway and DNS server:

```

IP CONFIG
IP: 192.168.1.88
MSK: 255.255.255.0
GW: 192.168.1.100
DNS: 8.8.8.8
BACK
  
```

There are two ways to modify each IP: clicking on the rotary encoder when the IP we want to change is highlighted will allow us to change the value for each of the four sections of the IP address between 0 and 255. We can increment or decrease by turning the rotary encoder. Clicking on the rotary encoder when we have the desired value selected will set the value and jump to the next section and so on until we have completed the IP address that is required. It is also possible to enter the numbers with the numeric keypad of the ALIO always completing the 3 digits. For example, if we want to type "6", we should type "0", "0", "6", then confirm each number clicking on the rotary encoder.

The **default** IP address for PHOENIX ALIO is **192.168.1.88**.

If any of the IP or mask is altered (either by selecting DHCP or manually changing it), the unit will ask the user for **confirmation** before **rebooting** and applying the new configuration when leaving the "ETHERNET" submenu.

3.7.5.3. "COMMUNICATIONS" submenu.

Advanced parameters related to RTP audio protocol (used in both IP and SIP communication modes) can be configured here:

```

COMMUNICATIONS
RTP
SIP
BACK
  
```

- **RTP:** Generic parameters that are always necessary for IP audio transmission using standard UDP type RTP (Real Time Protocol) are configured in this menu. Note that this protocol is always used, even when a higher level protocol such as SIP is active, so its configuration will be always available and required even if the channel is configured in SIP mode.

```

RTP (PROG)
BUFFER: fixed
SIZE: 100ms
SYMMETRIC RTP: off
LOCAL PORT: 5004
FEC: off
  
```

The parameters that can be configured in this menu are:

- Receiving **BUFFER** type (FIXED or ADAPTIVE size), as well as its **SIZE** in milliseconds, between 10 and 2000ms. A fixed size buffer is recommended whenever possible, unless the opposite is indicated by AEQ for a certain application. The size to select depends on the network performance, in particular, on the variation of the delay in packet delivery (jitter). The size specified for the buffer must be higher than the maximum variation. Note that a certain network may have a long delay, but quite constant (low jitter), as is the case in good satellite links. In this case, the buffer size can still be short.

Large buffer sizes results in unnecessarily long added delays. We recommend to start with a value around 100 ms, that the user should increase only in case that drops or occasional losses of synchronization is experienced. Such occasional loss is most likely due to that the network jitter at times may be larger than those 100ms. In order to diagnose network jitter, we recommend that the IP statistics available in the Web Server are used (read section 7.6 of this manual).

- Activation or deactivation of **SYMMETRIC RTP** mode, that sends the transmitted audio stream to the same IP and port that the unit is receiving from, independently from the setting of destination port (this option doesn't appear when "**SmartRTP**" mode is active, as it is no longer necessary).
- We must also specify the local audio port here (port where the unit expects to receive audio RTP traffic at). This **LOCAL PORT** is 5004 by default for program channel, and 5008 for the (optional) coordination channel. It must be a multiple of 4 and can be typed in with the numeric key-pad (always with 5 digits) or modified with the "NAVI / Ch" rotary encoder.

IMPORTANT NOTE: When audio local port is changed the **unit must be restarted** in order to make and receive calls correctly.

- Last, we can define here whether to use **FEC** (Forward Error Correction) or not. If enabled, the protection level (and consequently, increased overhead) must be specified among the 4 available options (LOWEST / LOW / MID / HIGH). Please refer to section 4.4 of this manual for more details about FEC.

- **SIP:** Next option in the communications menu corresponds to SIP configuration of the currently active channel. This option provides to display and modify information about the configured SIP user: user, password and active SIP PROVIDER, when the channel is configured in PROXY SIP mode (those parameters need to be setup in advance using remote control software) or just the user when it's configured in DIRECT SIP mode.

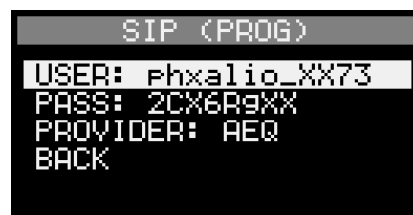

3.7.5.4. "MAINTENANCE" submenu.

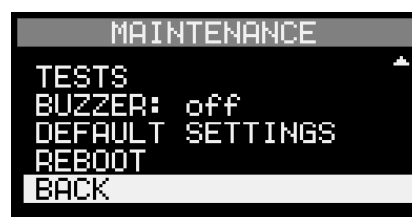
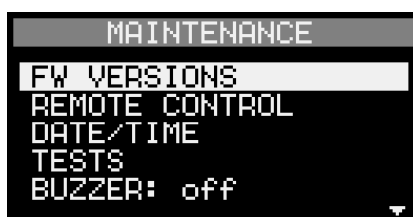

- **FW VERSIONS:** This menu can be accessed to check, for informative purposes only, the currently installed firmware versions (with their dates) of the different programmable devices within the unit (CPU, DSP and FPGA). The audio processor code is included in the CPU firmware file.

If, following indications from AEQ SAT, any device version must be updated; this operation must be done by using the equipment's Web Server, as explained in section 7.1 of this manual.

NOTE: Firmware updates don't modify (unless explicitly stated by AEQ) the current configuration of the unit and, in particular, its IP setup.

- **REMOTE CONTROL:** This option allows you to configure the parameters related to the outgoing control connection. If the "MODE" field is configured as "automatic", the unit will try to connect to the IP address and port indicated in the "SERVER" and "PORT" fields. This eases the control of units connected behind firewalls, for instance.
- **DATE/TIME:** It is possible to know the unit's date and time by selecting this option.

In order to adjust the date, connect a PC and use the "CONFIG" → "Miscellaneous" → "Equipment date and time" menu option in "AEQ ControlPHOENIX" software.

- **TESTS:** We can find some test functions under this menu, such as activation of audio loops for each channel, and test tone insertion (that substitute the corresponding input) for inputs MIC1 and MIC2, that we can route to the desired channel or CUE in order to make level adjustments, check audio connectivity, etc.

- The first and second lines allow for the activation of an audio loop in PROGRAM and COORD channels. This loop is linear (no compression). Audio entering the TX bus will be reflected back in the receive (RX) bus. This will also be shown in the corresponding vumeters and can be useful to measure audio performance, adjust levels, check connections, etc.

NOTE: LINEAR LOOP will become automatically deactivated when leaving the TEST menu, to avoid that it is accidentally left active.

- The third line option enables / disables the substitution of MIC1 input by a 1 KHz tone at 0 dBV level (adjustable between -inf and +18 dBV by means of the MIC encoder). The mentioned tone will be sent to the bus where MIC1 is routed, and the microphone will remain muted, if it is connected.
- The fourth line enables / disables the substitution of MIC2 input by a 2 KHz tone at 0 dBV level (adjustable between -inf and +18 dBV by means of the MIC encoder). The mentioned tone will be sent to the bus where MIC2 is routed, and the microphone will remain muted, if it is connected.

- **BUZZER:** The unit buzzer signals incoming calls and can be activated or deactivated through this function (it will sound once as a test whenever its status is changed from OFF to ON in this menu).
- **DEFAULT SETTINGS:** The systems factory settings can be restored at any time through this option. However, the units IP configuration will remain unchanged avoiding the loss of connectivity and remote control. **Confirmation** will be required before resetting the unit's adjustments.

IMPORTANT NOTE: The **SIP users** configuration of the unit will be lost when this option is activated. It's important to take note of these parameters before activating it in order to reconfigure them afterwards.



- **REBOOT:** The unit can be reset or rebooted in the event of unexpected or incorrect performance. **Confirmation** will be required before rebooting the unit.

3.7.5.5. "SPECIAL FEATURES" submenu.

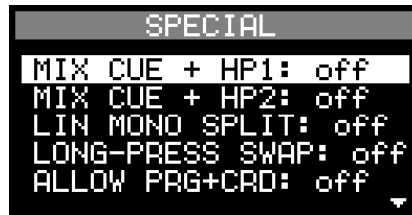

- **MIX CUE + HP1:** If this option is activated, regardless of the listening selection in HP1 (PROG or COORD), everything that is sent to CUE is mixed in that listening. Logically, if the selection in HP1 is CUE, everything that is sent to CUE will be heard regardless of the configuration of the MIX CUE + HP1 option.
- **MIX CUE + HP2:** If this option is activated, regardless of the listening selection in HP2 (PROG or COORD), everything that is sent to CUE is mixed in that listening. Logically, if the selection in HP2 is CUE, everything that is sent to CUE will be heard regardless of the configuration of the MIX CUE + HP2 option.
- **LIN MONO SPLIT:** If this option is activated, the line input will be sent in mono format as follows: if the sending to the PROGRAM channel is activated by means of the ON button, the R channel of the input will be sent, while if the sending to the COORDINATION channel is activated the L channel will be sent. If this option is disabled, the line input will be sent in stereo to the selected channel.

If the distribution mode is activated, that is, if "LONG-PRESS SWAP" and "ALLOW PRG-CRD" are activated, when activating the "MIX" on the line input by means of the ON button, the R channel will be sent to PROGRAM and the L channel to COORDINATION simultaneously.

- **LONG-PRESS SWAP:** If this option is activated, a new mode is implemented in the inputs and outputs control. A short press of the ON button of an input allows you to activate/deactivate the sending of that input to the current channel (by default, when turning on the equipment, to the PROGRAM channel), while a long press of that button when it's off allows to change to the other channel (COORDINATION if we started from PROGRAM). Once the change is made, a short press allows you to activate/deactivate now the sending of that input to the COORDINATION channel. The same happens with the press of the encoders associated to the outputs.

This way, when this mode is activated, if a commentator is on program for example and wants to mute its audio, there will be no need to go through coordination to do so. This mode, as indicated before, affects the 4 inputs and the 3 listening/outputs.

- **ALLOW PRG+CRD:** If this option is activated (in order to do this, the "LONG-PRESS SWAP" option must be previously activated), a third sending mode is implemented (distribution mode), which can be activated by long pressing of the ON button after turning off the sending to the COORDINATION channel: then the 2 lights of the ON button (red and green) turn on and the corresponding input is distributed to both PROGRAM and COORDINATION (MIX).

In the case of the outputs, it is also possible to use this mode, which allows listening to the PROGRAM signal on the left side and the COORDINATION signal on the right: when that sending is activated, the LED besides the encoder lights up in amber and the label "MIX" is displayed above the output level bar. In this case, the balance between send (TX) and reception (RX) for that output is applied on both channels. If additionally the "MIX CUE + HPx" option is activated, the signal that is sent to CUE will also be heard on both sides.

4. CONFIGURATION AND OPERATION FROM REMOTE CONTROL SOFTWARE.

Configuration and operation of Phoenix ALIO can be carried out remotely by means of the application "AEQ ControlPHOENIX" (AEQ TALENT, Phoenix ALIO, STRATOS, STUDIO, MERCURY, VENUS, VENUS V2, VENUS V3, VENUS V4 and VENUS V4+ Audiocodex Configuration and Control Software).

The version that is provided together with the equipment (2.2.2.1 or higher) can control up to **2 units** per software instance. If you need to manage more than 2 Phoenix audiocodexes at the same time, please contact AEQ sales department to purchase a multicodec-license for "AEQ ControlPHOENIX".

Furthermore, from version 2.2.1.50 of the application is **NOT** possible to control units with CPU version 5.50 or higher and units with previous versions **SIMULTANEOUSLY**. In that case, these last ones should be upgraded to version 5.50 or higher.

Please have the user manual of this application at hand. Install and configure it and add the equipment to the controlled equipment list in order to follow the explanations provided in this and following chapters step by step. This manual will describe particular ALIO options only, as well as some important procedures, while the detailed operation is detailed in "AEQ ControlPHOENIX" user's manual.

4.1. Individual codec control window.

The individual codec control window is thoroughly described in chapter 6 of "AEQ ControlPHOENIX" user's manual. The screen corresponding to Phoenix ALIO is as follows:

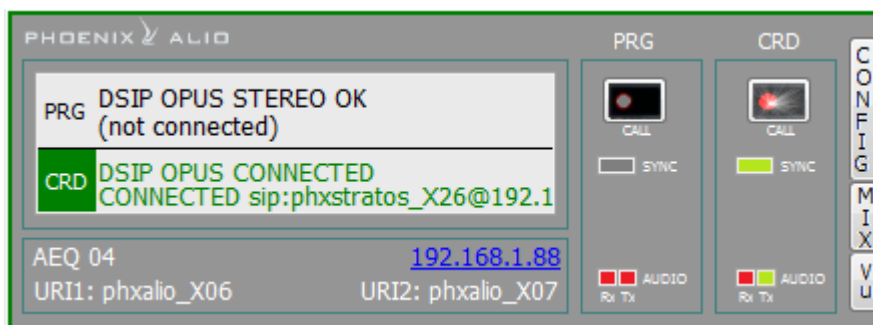

The name assigned to the device can be seen in the lower area of the window ("AEQ 04" in this example), as well as the URI corresponding to both channels (URI-1 → PROGRAM, URI-2 → COORDINATION)

Additionally, a blue link is presented with the equipment's IP address. By clicking on this link, an Internet browser will pop up showing Phoenix ALIO Web management window allowing, among other things, to update firmware and obtain real-time IP traffic statistics when the channel/s is/are connected.

When the unit has no license for COORDINATION channel activation, the screen will look slightly different, as the control area for that channel will appear deactivated:

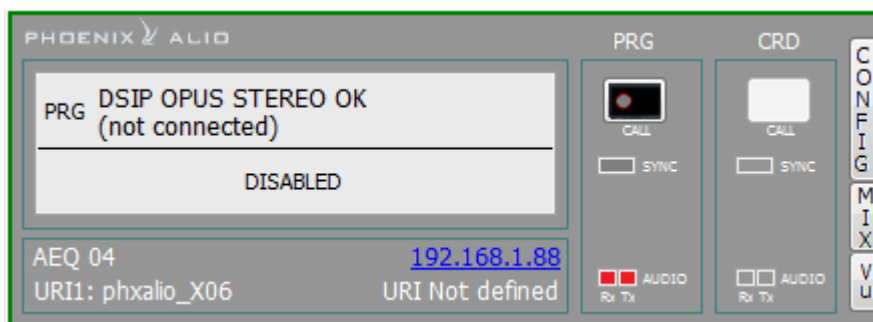

The left zone shows the general status of both communications channels, PROGRAM (PRG) and COORDINATION (CRD) (CONNECTED, OK, REGISTERING, etc), as well as the configured working mode and encoding and the remote equipment's data (IP address and port or name) in case it is connected. We can click in any of both areas in order to show a window that provides all the details of the channel we have clicked on:

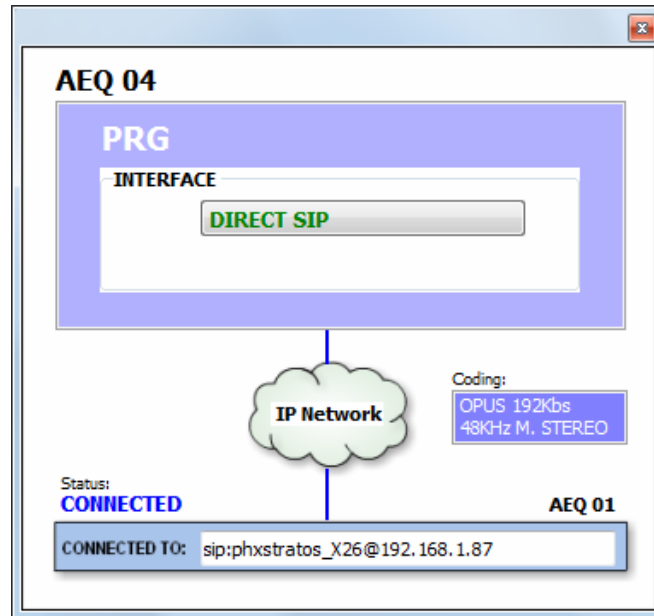

- **INTERFACE:** indicates the operating mode of the channel (RTP Raw, DIRECT SIP or Proxy SIP)
- **Coding:** indicates the coding algorithm or profile: OPUS, G711, G722, MPEG L2, <SIP CODEC PROFILE>... This section also indicates **binary rate** (128 Kbps for example), the **sampling frequency** (48 KHz, for example) and the **mode** (Mono, Stereo, Dual, JStereo or MS Stereo).
- **Status:** SIP registering status for IP connections using Proxy SIP mode ("REGISTERING", "REGISTRATION_ERROR", "REGISTERED") or interface status ("OK", "CONNECTED", "CONNECTED_NO_DATA / NO_SYNC").
- **CONNECTED TO:** calling/called equipment's name or number (identifier, number or Unknown when ID is not provided) or "not connected" when there is no established communication.

The lower part of the individual codec window identifies each unit by its given name, IP address and each channel URIs (identifier for SIP calls) for each of both channels:



On the right part, for both channels, PROGRAM and COORDINATION, we can find the "CALL" button/indicator and the "SYNC" indicator, as well as two audio presence indicators for both directions: transmission ("Tx") and reception ("Rx").

4.1.1. CONFIG Menu.

At the right side, "CONFIG" button gives access to a configuration menu with the following options: "General", "Contacts", "Ethernet", "Miscellaneous" and "Network".

Just click on "CONFIG" button again in order to close this menu.

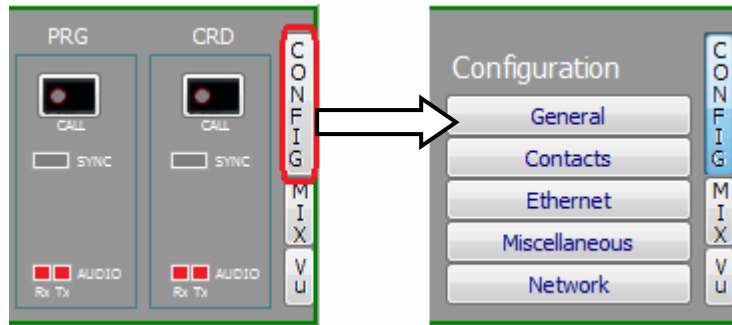

The "General" option is the most important of the ones associated to "CONFIG" button: you can configure the audio routing and levels from/to the equipment, the selected audio encoding algorithm, the interface to be used (from "INTERFACE" drop-down menu) and access to "Advanced" channel configuration and IP interface configuration ("I/F Setup" button).

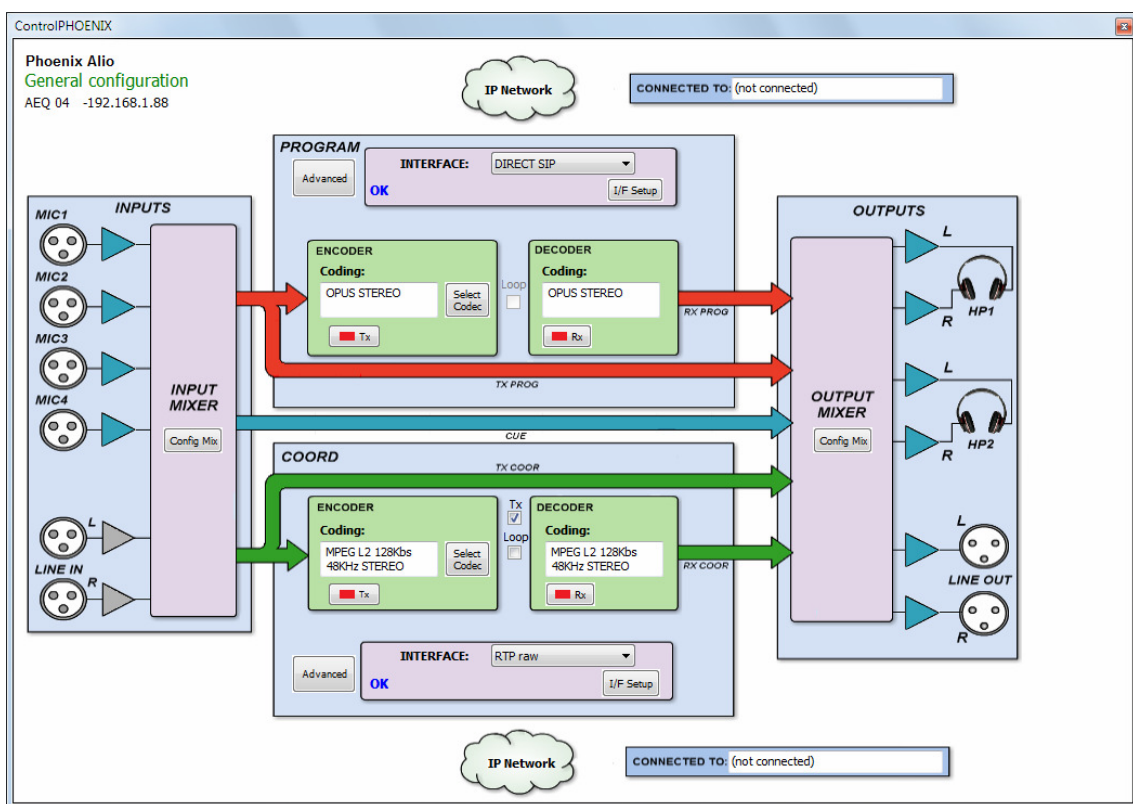

If the unit doesn't have a valid COORDINATION channel activation license, the appearance will be slightly different, as the control zones for that channel will appear deactivated:

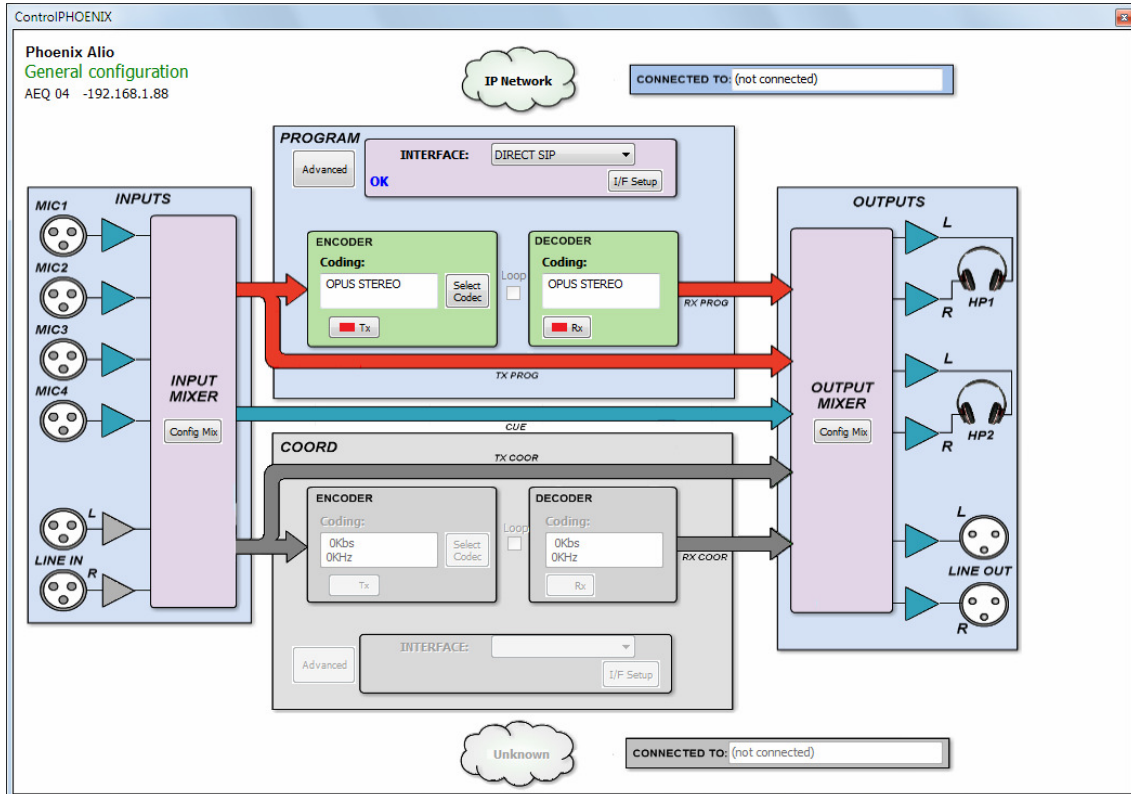

The general view offers a graphic display of the audio flow inside the unit. The equipment's inputs are shown at the left, entering the input mixer (that can be opened by clicking on the "Config Mix" button –see paragraph 4.1.2).

This mixer outputs three buses: PROGRAM send (depicted in red), COORDINATION send (depicted in green) and CUE prelisten (represented in blue).

The first bus is sent to the PROGRAM block where several aspects related to communications (communication type, ports, etc), coding algorithms, etc. can be configured.

The second bus is sent to the COORDINATION channel that, if licensed, allows the same configuration as PROGRAM.

The CUE bus is routed directly to the outputs block, as explained below.

The output block is presented at the right, where two stereo headphones and a stereo line output appear. PROGRAM and COORDINATION send and receive buses, as well as CUE, arrive to this block in order to be able to output or monitor them.

The "OUTPUT MIXER" block allows for the configuration of the assignment of buses to outputs, level control and send/receive balance adjustment for each one.

The amplifier symbols at the inputs are filled with the colour corresponding to the bus they are being routed to, in order to ease a quick identification of the routing at a glance. Each output, on the other hand, is colored with the colour code of the bus that is being routed to it.

NOTE: The "Config Mix" button opens the complete mixer that controls both the inputs and the outputs, just the same as the "MIX" button located at the right side of the individual codec window, as you can see in section 4.1.2.

Other available options within the "CONFIG" menu are "Contacts" (call book management), "Ethernet" (IP configuration of the device), "Miscellaneous" (various adjustments) and "Network" (auxiliary network functions configuration). The details of these menus are described in **chapter 6** of "AEQ ControlPHOENIX" user's manual. The "Miscellaneous" option allows you to **activate** the **COORDINATION** channel, if the corresponding **license** has been purchased.

Just click on the "CONFIG" button again to close this menu.

4.1.2. Mixer control window.

Also at the right side, the "MIX" button opens a window where all parameters of the ALIO mixer can be controlled: level and gain for all inputs, input routing, tone adjustments, indication of MIC4 or LINE IN selection, output routing and level, etc.

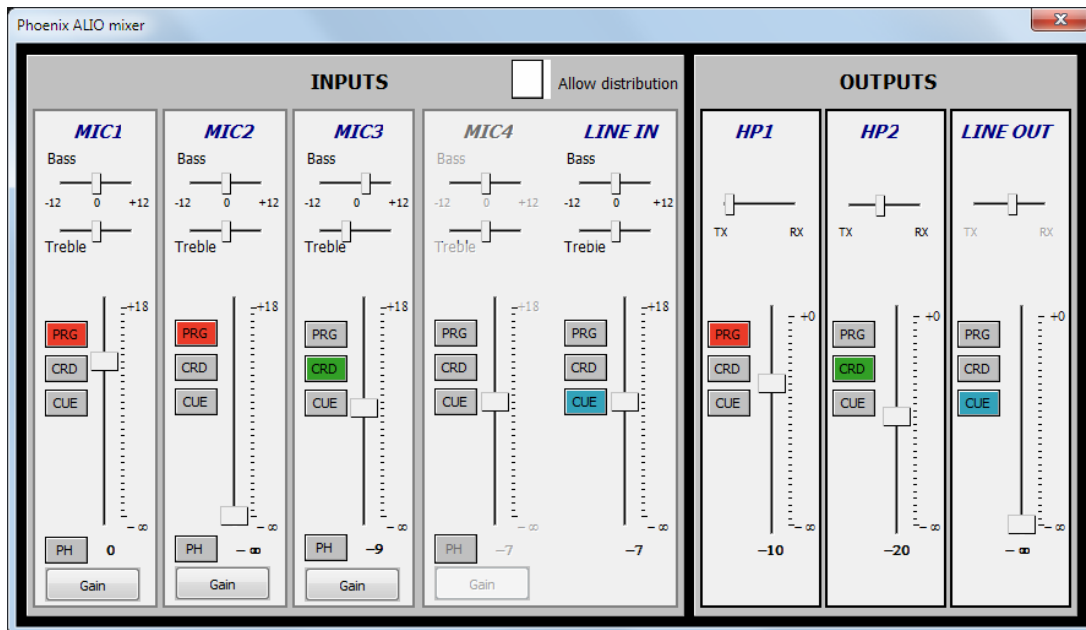

Audio can be controlled in real-time from this screen, alternatively or in parallel with the unit front panel, from the control PC, that can be located either at the side of the unit or remotely.

MIC1, 2 and 3 input channels feature the following controls:

- Send assignments: allow the user to select which bus the corresponding input is sent to (PROGRAM, COORDINATION or CUE). These buttons are mutually exclusive, and when activated, they will be filled in the colour assigned to the corresponding bus (red, green or blue, respectively), as well as the input amplifier symbols in the General view, allowing for a quick identification of the inputs routing at a glance.
- Mix fader: allows adjustment of the corresponding input mix to the selected bus between -infinity (mute) and +18dB. The selected value is shown below the fader, at the right of "PH" button.
- Tone controls: bass and treble, permitting an adjustment between -12 and +12dB, individually for each input.
- "PH" (Phantom) button: activates or deactivates Phantom supply (12V / 10mA) for the corresponding microphone.
- Gain: clicking this button opens a window to control the gain of each preamplifier in a range from 0 to +65dB (for microphone inputs only).

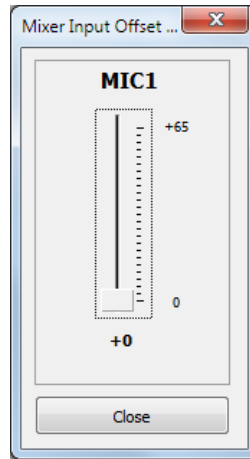

MIC4 and LINE IN inputs are mutually exclusive, what means that, once the bus send assignment is changed from one of them, the other will become inactive.

The right area of the Mixer window allows control of the three outputs (2 headphones + LINE out) in a similar way: the source can be selected for each output from CUE, PROG or COORD buses. These buttons are mutually exclusive, and when activated, they will be filled in the colour assigned to the corresponding bus (red, green or blue, respectively), as well as in the output amplifier symbols in the General view, allowing for a quick identification of the outputs outing at a glance.

Each output's volume can be varied between 0dB and -infinity (mute). The balance between transmission and reception that the ALIO operator has adjusted on the front panel can be viewed as well, but only for informative purposes (this adjustment cannot be remotely controlled).

The **"Allow distribution"** checkbox allows you to temporarily (while the mixer control window remains open) activate the distribution mode in order to simultaneously activate the send of inputs to PROGRAM and COORDINATION or the send of those buses to the outputs from the mixer of ControlPHOENIX itself. If the window is closed, that simultaneous sending remains active. When opening the mixer window again, the "Allow distribution" checkbox appears disabled by default. This option works regardless of whether or not the distribution mode is activated on the unit itself from the "SPECIAL FEATURES" submenu (see section 3.7.5.5 of this manual).

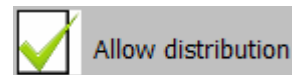

4.1.3. Vumeters window.

Last, you can access to the equipment's remote vumeters by clicking on the "VU" button located below "MIX" one. They will appear into a floating window that you can move to the desired position. **By default**, it is possible to open up to **2 vumeters windows** in the application (for example, to check audio transmission between two connected equipments under the application's control). If you try to open a third vumeter window, the first one will be closed. Click on the right top cross in order to close a vumeters window.

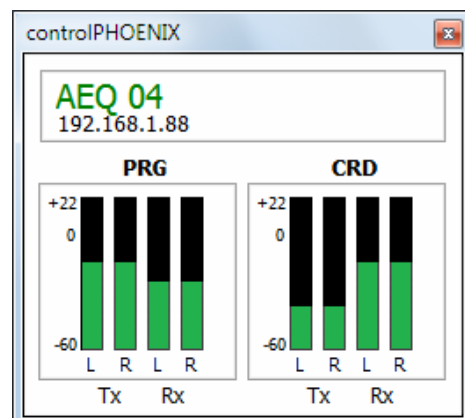

The **maximum number of vumeters** that can be simultaneously displayed can be altered in the "Remote connection" tab of "General Application Values" (see section 5.1.10.1 of "AEQ ControlPHOENIX" user's manual).

The represented vumeters correspond, for both channels (PRG=PROGRAM, CRD=COORDINATION), and from left to right, to audio transmitted to the channel (L and R) and received from it (also L and R).

4.2. Connection modes.

In order to establish an IP communication using PROGRAM or COORD channels, first we need to choose one of the three available connection modes: "PROXY SIP", "DIRECT SIP" and "RTP Point to Point (RAW)" from the "INTERFACE" drop-down menu of the desired channel. This is the same as selecting the communications mode with the front panel "SIP" / "IP" and the use or not of an external Proxy under MENU → COMMUNICATIONS → SIP.

We can access the IP configuration submenu by clicking on "I/F Setup". This menu is described in sections 6.1.4.2 and 6.1.4.3 of "AEQ ControlPHOENIX" user's manual.

It is important to know the details of each type of connection, so they are explained below.

4.2.1. RTP Point to Point (RAW).

This type of connection is selected when the connection over IP will be an RTP type link with calling of the (IP address:port) to (IP address:port) type. Obviously there is no advanced signaling protocol in this scenario and you will need to established, set parameters and disconnect communication from both ends. Audio encoding must be the same (and explicitly specified) in both ends of the communication.

In order to avoid that hassle, making the calling, hanging up and coding selection tasks easier, as it will be necessary to do it from one end only, "**SmartRTP**" can be activated in both involved audiocoders (provided that they are AEQ Phoenix compatible with this mode).

If the operating mode required for a contact is "**RTP raw**", the only valid equipment identifier is:

<IP_address>:<destination port>, for example: "**172.26.33.28:5008**"

The specified destination port must match the Local port set up for the remote equipment. That is, in order to make a RTP call, we must know the IP address and local port of the remote unit even if "**SmartRTP**" is used.

When you create a Call Book, these fields describing a contact can be modified in the Call Book that can be accessed from a codec individual control window through the "Contacts" option in "Configuration" (see section 5.1.7 of "AEQ ControlPHOENIX" user's manual).

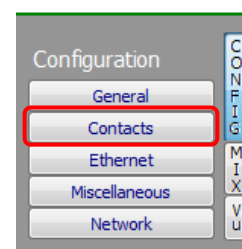

You can access the IP configuration submenu for RTP Raw mode by clicking on "I/F Setup" button, and that it is explained in section 6.1.4.3 of "AEQ ControlPHOENIX" user's manual.

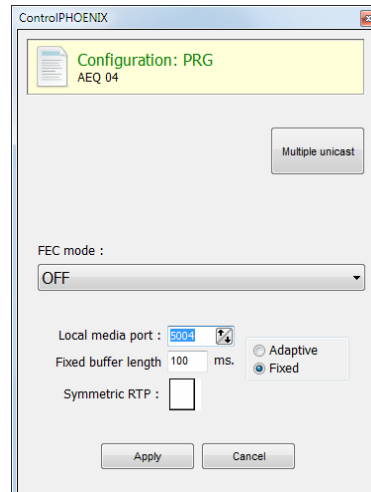

The parameters to be configured are:

- **FEC mode:** this option allows you to configure whether FEC (Forward Error Correction) is used or not (there is a trade-off for a bigger binary rate). See section 4.4.
- **Local media port:** this option allows you to configure the value of the IP port selected to transmit audio at origin over IP. Minimum value 1,024. Maximum value 65,534. Default values: 5004 (PROG) and 5008 (COORD).
- **Adaptive / Fixed and Adaptive buffer max/min / Fixed buffer length:** this option allows you to configure the type and size of reception buffer. See section 4.4.
- **Symmetric RTP:** when "**SmartRTP**" mode is not activated, this advanced option at least allows the user to force the local unit to send audio to the same IP and port from which it is receiving audio. The destination port specified when making the call will be ignored when we receive packets from the remote equipment. This option will allow you to connect to an audiocodec with unknown IP and/or port (because it's behind a router with NAT, for instance).

Please notice that "RTP Point to Point" is a complex configuration mode, suitable for permanent connections that some equipment may not support. Specifically, it can't be used to connect to Phoenix Mobile. However, it becomes an easy and effective way to operate with the aid of "**SmartRTP**".

4.2.2. PROXY SIP.

This type of connection is selected when the Phoenix ALIO is used working together with an external SIP server that will provide connection with remote unit through any network, even Internet, without knowing its IP address. Both units (local and remote) must be registered in SIP server, which function is to maintain a database with the registered codecs, storing their connection parameters (IP address, audio ports...) in order to ease the task of making calls between them even when connected to different networks.

In order to make a call in Proxy SIP mode, you must take into account that for the **URI** or SIP identifier of the equipment in question you can use any of the following syntaxes:

- **<unit_name>**, for instance: "phxalio_231" o "phoenixMaster"
- **<unit_name>@<realm_SIP_server>**, for instance: "phxalio_231@sip.aeq.es" or "phoenixMaster@sip.aeq.es"
- **<unit_name>@< SIP_server_IP>**, for instance: "phxalio_231@232.168.1.2" or "phoenixMaster@232.168.1.2" (where 232.168.1.2. is the AEQ's SIP server "sip.aeq.es")

- **<unit_name>@<SIP_server_IP>:<Port>**, when the SIP port of SIP server is not the 5060 (SIP Standard port) the identifier must include the used port, for instance: phxalio_231@sip.aeq.es:5061

When you create a Call Book, these fields describing a contact can be modified in the Call Book that can be accessed from a codec individual control window through the "Contacts" option in "Configuration" (see section 5.1.7 of "AEQ ControlPHOENIX" user's manual). In order to call a same contact using different IP modes (as defined in "INTERFACE" drop-down menu), different contact entries must be created.

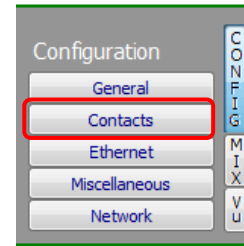

You can access the IP configuration submenu for PROXY SIP mode by clicking on "I/F Setup" button, and that it is explained in section 6.1.4.2 of "AEQ ControlPHOENIX" user's manual.

- In "**SIP Parameters**" submenu you can find the following parameters (the first 3 only appear when pressing the "**Advanced**" button):

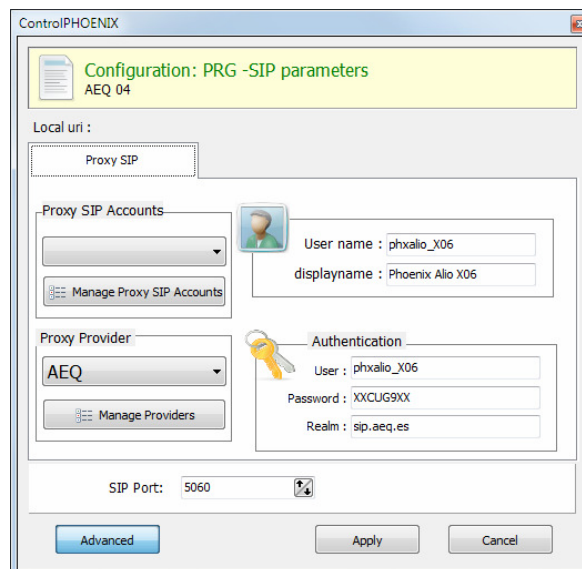

- **User Name:** enables you to edit the name of the unit and how it will be reflected in the diverse internal menus of the unit. For a start we recommend you not to change the configured default User Name, "phxalio_231" for instance.
- **Display Name:** editable name. This is the public name of the equipment that will be used in SIP server, so you can recognize the equipment with this identifier externally to the system.
- **Proxy SIP Account:** enables you to select a Proxy SIP account from a previously created and stored list. In case an account is selected, the parameters described next would be automatically loaded (confirmation is requested).
- **Proxy Provider:** enables you to select the external SIP server with which the unit will work from a previously stored list. By default, AEQ server will be selected.
- **Authentication:** enables you to edit the password and security information for the user profile associated with the unit in the previously selected SIP server. By default, the data configured in this field in order to use AEQ server are the following:
 - **User:** the "User Name" configured in Factory, "phxalio_231" for instance.
 - **Pwd:** the Password associated to that user.

- **Realm:** the domain where the SIP Server is located, by default: sip.aeq.es.
- **SIP Port:** enables you to configure the SIP port. If this parameter is modified, it is recommended to restart the unit to ensure that the configuration takes effect.
- You can find the NAT mode selection at "**NAT Traversal**" submenu.

NAT Traversal is a set of tools used by the equipment in order to surpass the NAT (Network Address Translation) performed by some routers. We can select among several modes depending on the kind of network the unit is connected to.

Phoenix ALIO offers a total of six different operating modes when traversing devices with NAT (routers, firewalls...). Each one of those modes is suitable for a different scenario. For instance, when the units that are establishing communication are in the same local network, the internal working way will be different than when it's done through the Internet.

See more details in section 4.3 of this manual.
- The rest of options to be configured are:
 - **FEC mode:** this option allows you to configure whether FEC (Forward Error Correction) is used or not (there is a trade-off for a bigger binary rate). See section 4.4.
 - **Local media port:** this option allows you to configure the value of the IP port selected to transmit audio at origin over IP. Minimum value 1,024. Maximum value 65,534. Default values: 5004 (PROG) and 5008 (COORD).
 - **Adaptive / Fixed** and **Adaptive buffer max/min / Fixed buffer length:** this option allows you to configure the type and size of reception buffer. See section 4.4.
 - **Symmetric RTP:** this option allows you to force the local unit to send audio to the same IP and port from which it is receiving audio. The destination port specified when making the call will be ignored when we receive packets from the remote equipment. This option will allow you to connect to equipment with unknown IP and/or port (because it's behind a router with NAT, for instance).

Each unit will send audio to the "Local media port" of the remote equipment automatically, thanks to the SIP signaling protocol. That signaling also accomplishes coding profile negotiation and call establishment / release from any of both sides of the communication once the remote equipment has been identified by its IP address and reached.

4.2.3. DIRECT SIP.

This type of connection is selected when you have a connection with SIP protocol in the signaling phase prior to connection but without the presence of an external SIP server. It is necessary to know the IP address of the equipment you want to call in advance, but not necessarily the audio ports.

In order to call in Direct SIP mode, you must take into account that for the **URI** or SIP identifier of the equipment the right syntax is "<unit_name>@<unit_IP_address>" type (for instance, "phxalio_231@172.26.5.57").

When the correspondent **SIP port** is not the 5060 (SIP Standard port) the identifier must include the used port. For instance: "phxalio_231@172.25.32.11:5061".

When you create a Call Book, these fields describing a contact can be modified in the Call Book that can be accessed from a codec individual control window through the "Contacts" option in "Configuration" (see section 5.1.7 of "AEQ ControlPHOENIX" user's manual). In order to call a same contact using different IP modes (as defined in "INTERFACE" drop-down menu), different contact entries must be created.

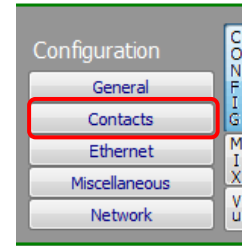

You can access the IP configuration submenu for DIRECT SIP mode by clicking on "I/F Setup" button, and that it is explained in section 6.1.4.2 of "AEQ ControlPHOENIX" user's manual.

- In "SIP Parameters" submenu you can find:
 - **User Name:** enables you to edit the name of the unit and how it will be reflected in the diverse internal menus of the unit. For a start we recommend you not to change the configured default User Name, "phxalio_231" for instance.
 - **Display Name:** editable name. This is the public name of the equipment, so you can recognize the equipment with this identifier externally to the system.
 - **SIP Port:** enables you to configure the SIP port. If this parameter is modified, it is recommended to restart the unit to ensure that the configuration takes effect.

- You can find the NAT mode selection at "NAT Traversal" submenu.

NAT Traversal is a set of tools used by the equipment in order to surpass the NAT (Network Address Translation) performed by some routers. We can select among several modes depending on the kind of network the unit is connected to.

Phoenix ALIO offers a total of six different operating modes when traversing devices with NAT (routers, firewalls...). Each one of those modes is suitable for a different scenario. For instance, when the units that are establishing communication are in the same local network, the internal working way will be different than when it's done through the Internet.

See more details in section 4.3 of this manual.

- The rest of options to be configured are:
 - **FEC mode:** this option allows you to configure whether FEC (Forward Error Correction) is used or not (there is a trade-off for a bigger binary rate). See section 4.4.
 - **Local media port:** this option allows you to configure the value of the IP port selected to transmit audio at origin over IP. Minimum value 1,024. Maximum value 65,534. Default values: 5004 (PROG) and 5008 (COORD).
 - **Adaptive / Fixed and Adaptive buffer max/min / Fixed buffer length:** this option allows you to configure the type and size of reception buffer. See section 4.4.
 - **Symmetric RTP:** this option allows you to force the local unit to send audio to the same IP and port from which it is receiving audio. The destination port specified when making the call will be ignored when we receive packets from the remote equipment. This option will allow you to connect to an audiocodec with unknown IP and/or port (because it's behind a router with NAT, for instance).

Each unit will send audio to the "Local media port" of the remote equipment automatically, thanks to the SIP signaling protocol. That signaling also accomplishes coding profile negotiation and call establishment / release from any of both sides of the communication once the remote equipment has been identified by its IP address and reached.

4.2.4. Sending audio to multiple destinations: Broadcast, Multicast and Multi-unicast.

It is possible to send the same audio RTP stream to several different destinations in "RTP raw" mode (see section 4.2.1). There are several possibilities to do so (see "AEQ ControlPHOENIX" manual):

a) Broadcast: the audio stream can be sent to all the equipments within a local network, only by specifying a special address in the destination address field. This address is calculated as the network address with the equipment part filled with 1's. For instance: if the IP address of our codec is 192.168.20.3 and network mask is 255.255.255.0, the corresponding broadcast address is 192.168.20.255. However, if the network mask was, for example, 255.255.0.0, then the broadcast address would be 192.168.255.255. The audio will be sent to a given port, so the receiving equipments should have "local media port" set up to this same port so they are able to receive the RTP stream.

This mode is not recommended for big networks and is usually blocked by the switches and routers, so its use is restricted to small, well managed local area networks.

b) Multicast: it is also possible to send the audio stream to a special "multicast" address, for example, 239.255.20.8. If the receiving equipments call to that same IP, they will receive the audio that is being sent provided that their "local media port" matches the one the transmitter is sending the packets to. Phoenix ALIO implements IGMP (Internet Group Management Protocol) in order to subscribe to multicast group. Similarly to broadcast, multicast traffic is usually blocked by switches and routers, so its use is restricted to local area networks too.

c) Multiple-unicast: Phoenix units can send the same RTP stream to several different IPs by replication of the encoded audio. This can traverse switches and routers in the same way it would do if it was a simple (unicast) RTP Raw stream, although it is limited to a certain number of destination IPs depending on the type of coding algorithm.

That parallel streams or "replicas" at nothing more than IP address + port pairs, where audio copies are to be sent normally. When a contact is created or edited, it is also possible to specify whether particular replicas use FEC (forward error correction) if it is enabled for that channel, or disable it for certain streams (because they use stronger links, for example). If the above list is empty, the audio stream will be sent to the IP + port specified when making the call (main address in the contact).

In order to send replicas, a new advanced contact must be created first in the General agenda where a main IP address and port is specified and a list of additional replicas is provided. In order to do that, click on the "Contacts" button at the top menu bar, select "New Contact" (make sure that the agenda selected at the left column is "General" and proceed with the creation of the new contact:

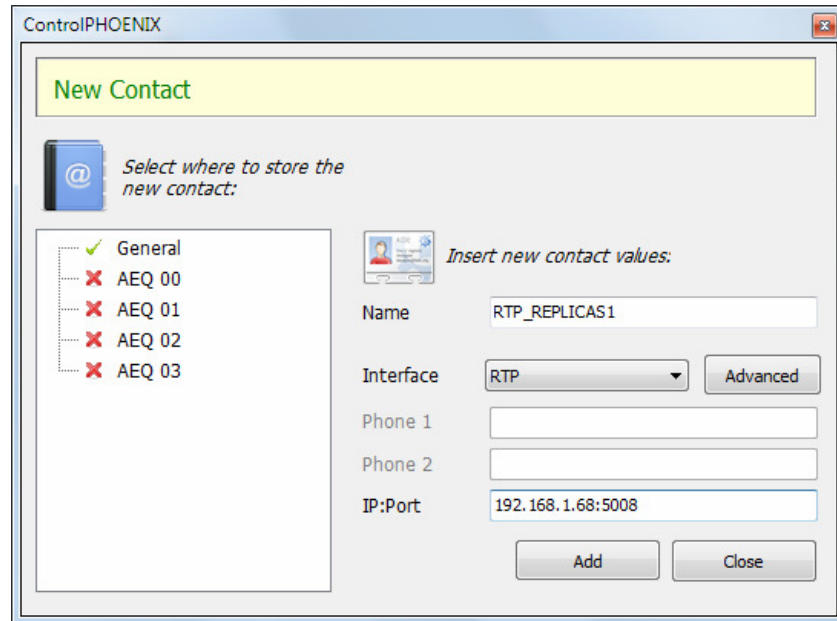

Give the new contact a name (i.e: "RTP_REPLICAS1"), select RTP as the interface mode, specify the main destination IP address and port (192.168.1.68:5008, respectively, in this example) and click on the "Advanced" button to specify the selected coding method and add replicas to the list.

The OPUS MUSIC STEREO 48 KHz / 64 Kbps mode will be used in this example, configuring the contact to issue replicas to 2 different IP/Port pairs (we have used the "New Replica" button in order to do that).

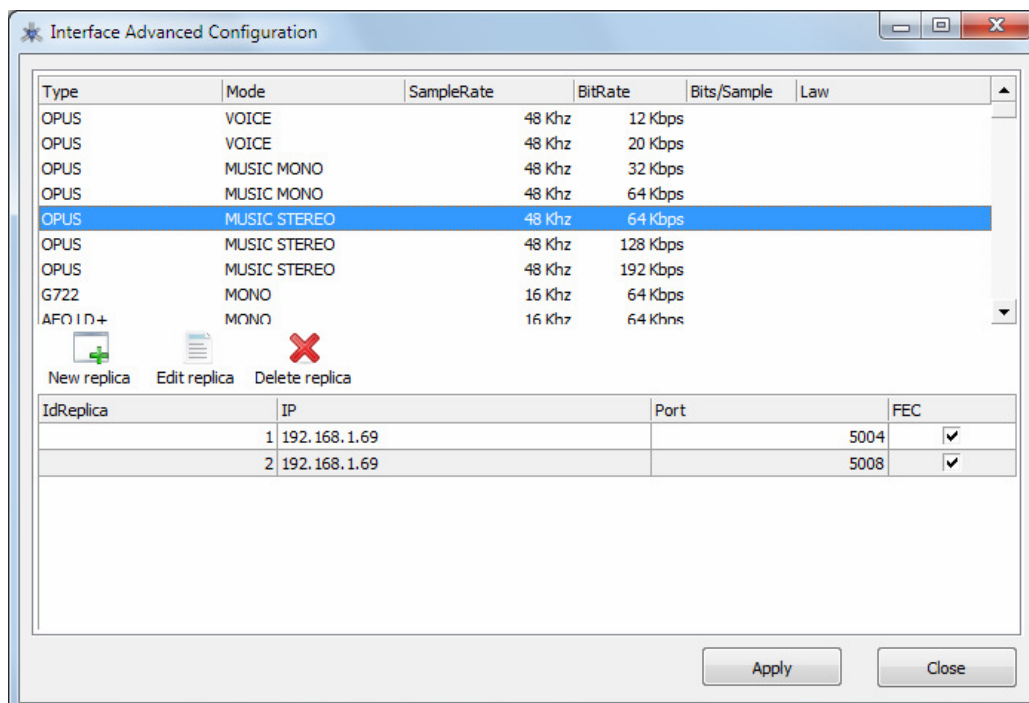

Detail of the creation o RTP replicas within a General agenda contact

Please check chapter 5.1.7.1 of "AEQ ControPhoenix" User's manual for more details.

We need to select this contact that includes replicas from the call window when making a call.

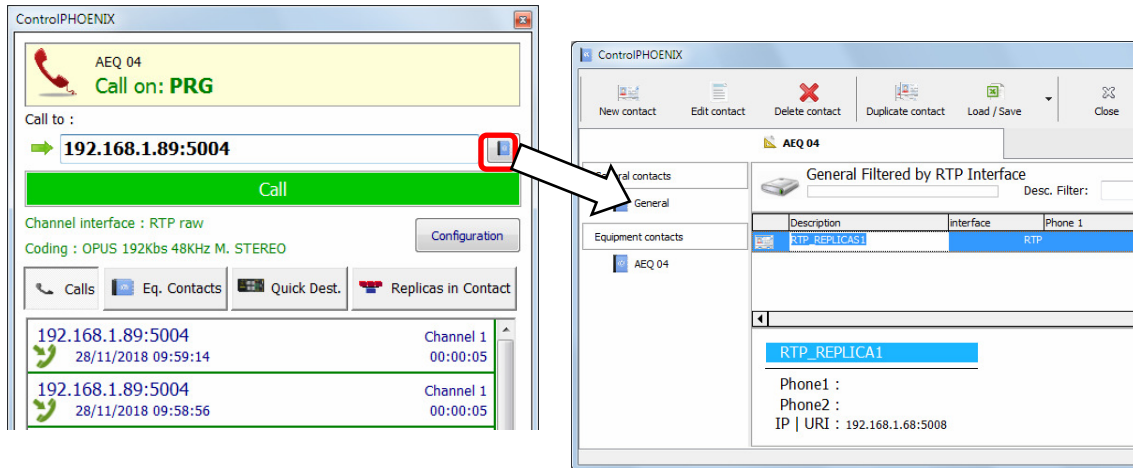

Once the available contacts are displayed, select the one we are interested in ("RTP_REPLICAS1" in this example), by double-clicking its name, and we will be returned to the call window.

At this moment we are able to check that the specified main IP address and port fields fill the "Call to" field, and we can also check that the replicas are going to be loaded into the unit, by clicking on the "Replicas in Contact" before actually making the call:

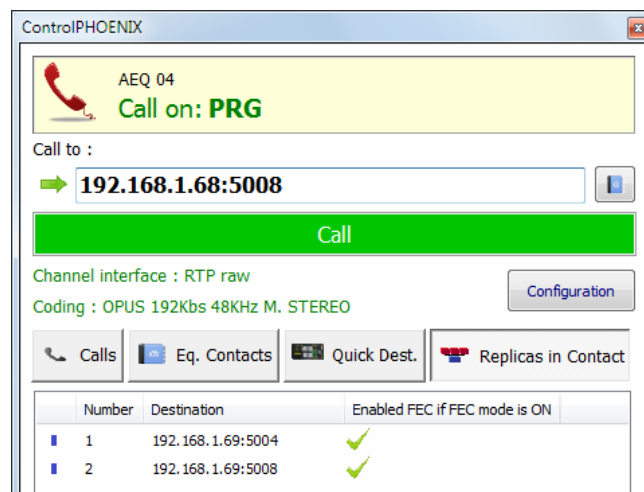

Once we click on the green "Call" button, the unit will start emitting the audio streams to the main address and to the specified replica addresses.

ALIO will stop sending replicas as soon as the call is hung. The list will be erased from the unit and the only way to send them again is to call selecting the same contact.

However, if the Permanent Call mode is activated and there is a mains cut, for example, the unit WILL send all configured replicas when rebooting.

NOTE 1: When audio is transmitted to several destinations, it can be received from only one of them (or none) In order to establish which of the units sends the audio back, and only in RTP Raw mode, a control will appear in the general configuration window that allows for the activation / deactivation of the transmitted stream to the IP channel. Make sure that only one of the units connected to the multicast transmitter has this checkbox activated.

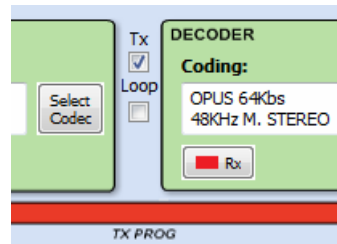

Channel transmission activated

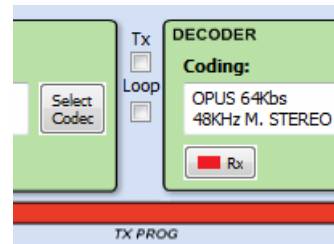

Channel transmission inhibited

NOTE 2: Advanced contacts (those allowing specification of the communication mode, coding algorithm/profile, replicas, etc) can only be stored in the General agenda, that is saved in a database in the control PC. These contacts can however be copied to the different devices, but the advanced fields (interface, coding algorithm, SIP account / provider and replicas) will be lost, so only the contact name and contact data (main IP:port or destination URI) will be stored.

NOTE 3: It is possible to use multiple-unicast transmission with "**SmartRTP**" active. The transmitter unit must be the one that generates the calls, and when it hangs up, it will send notifications to the MAIN destination only (not in the replicas). As a consequence, only this one will hang-up. If the user needs that all receivers hang-up too, the "Auto Hang-Up" option can be activated on them defining a reasonable time (let's say, 5-10 seconds). If, on the other hand, we need to cut the call from a receiver, only that with transmission enabled will make the others hang-up (even if it is not the main receiver).

Please read the application notes published by AEQ regarding IP connectivity for more information on IP communications in particular scenarios.

4.3. NAT TRAVERSAL.

NAT Traversal is a set of tools used by the equipment in order to overcome the issues caused by NAT (Network Address Translation), performed by some routers. We can select among several modes depending on the kind of network the unit is connected to.

For IP connections using SIP protocol, Phoenix ALIO offers a total of six different operating modes when traversing devices with NAT (routers, firewalls...). Each one of those modes is suitable for a different scenario. For instance, when the units that are establishing communication are in the same local network, the internal working way will be different than when it's done through the Internet.

Four of the six modes are automatic (AUTO 1 - AUTO 4), another one is manual (MANUAL - router configuration) and the last one (OFF - there is no NAT) is used when no devices with NAT are crossed (the unit is in a local network or connected to the Internet with a single workstation router). In automatic modes the unit tries to find out its public IP and ports without the user help, while in manual mode the unit gets those data directly from user (and user gets it from network administrator).

Due to the technical complexity inherent in most of the parameters involved in this NAT TRAVERSAL menu and the importance that any modification has in the final operation of the unit, we recommend that only highly qualified personnel in possession of all the technical documentation and manuals work on this NAT configuration menu. For additional information, see **APPENDIX B5**.

The NAT traversal options of a codec are accessed by following this sequence from the involved individual codec control window: "Configuration" → "General" → "I/F Setup" → "NAT Traversal".

Next we will describe the operation without NAT and the other five modes supported by Phoenix ALIO.

4.3.1. Operation without NAT: "OFF (there is no NAT)".

The unit uses no mechanism to traverse devices with NAT. This mode will be used only to operate in the local network (all of the SIP participants are in the same local network, including the Proxy SIP, if we use it).

4.3.2. Manual NAT: "MANUAL (router configuration)".

This mode will be used when the unit is connected to a local network with shared Internet access, through a router that will work as NAT (Network Address Translation). In order to use this mode no DHCP must be used and you need to have access to router configuration (and the knowledge to do it) or to the Network Administrator that will give us some data to be configured in the unit and configure the router to open and redirect some IPs and ports (port forwarding).

The procedure is described in detail in the following Application Note (we recommend you to read it when you decide to use this working mode):

AEQ PHOENIX AUDIOCODECS. APPLICATION NOTE 0 - C

(Connecting AEQ Phoenix units through Internet. Complex scenario configuration. Through LOCAL network(s), DHCP not used, manual NAT. Making use of AEQ Proxy SIP).

The eight parameters to be configured in the dialog for this mode are:

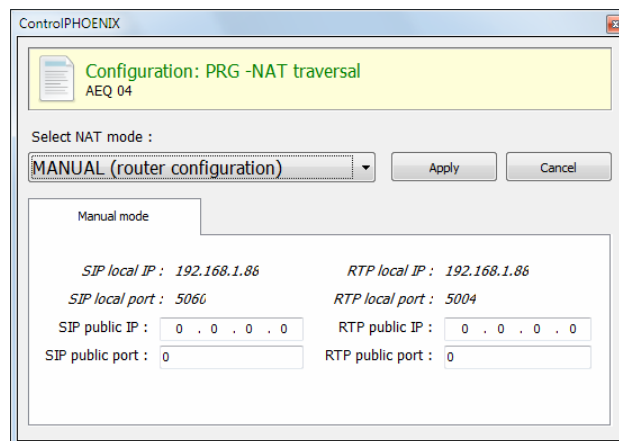

1. **SIP LOCAL IP:** read-only parameter that tells you the IP of the IP interface of the unit as regards SIP, so that the latter can, in turn, convey this to the router or firewall administrator when it is configured. For instance [192.168.1.88](#). It can be set in order to adapt it to network necessities in menu: "Configuration" → "Ethernet".

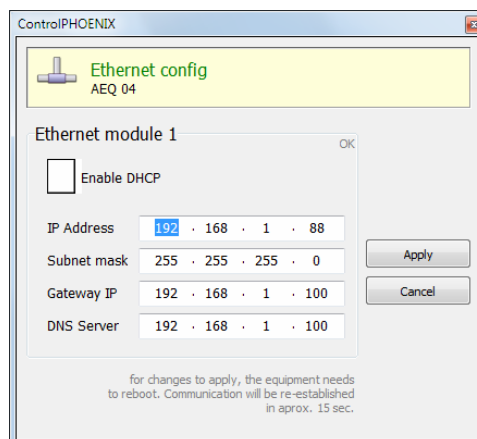

2. **SIP LOCAL PORT:** read-only parameter that tells you the port of the IP interface of the unit used for SIP signaling, so that the latter can, in turn, convey this to the router or firewall administrator when it is configured. Before checking the value of this parameter you should have configured previously whether you want to work with Proxy or not and restart the unit.
3. **SIP PUBLIC IP:** parameter that will tell the unit which public IP will correspond to it, so that it can include the said IP in its SIP messages. The router or firewall administrator must tell you the value of this parameter. For instance [212.170.180.177](#)
4. **SIP PUBLIC PORT:** parameter that will tell Phoenix which public port it will have corresponding to its local SIP port. The router or firewall administrator must tell you the value of this parameter in order to make the required port-forwarding. For instance: 8001.
5. **RTP LOCAL IP:** read-only parameter that tells you the IP of the IP interface of the unit as regards RTP, so that it can, in turn, convey this to the router or firewall administrator when it is configured. You will usually configure the same network interface as for SIP, so it will be the one configured in point number 1: for instance [192.168.1.88](#)
6. **RTP LOCAL PORT:** read-only parameter that tells you the port of the IP interface of the unit as regards RTP, so that the latter can, in turn, convey this to the router or firewall administrator when it is configured. Usually the shown port is 5004.
7. **RTP PUBLIC IP:** parameter that will tell the unit which public IP will correspond to the RTP of its IP interface, so that it can send the said IP in its SIP messages. The router or firewall administrator must tell you the value of this parameter. Usually the administrator will take out SIP traffic and RTP using the same public IP configure in point number 3. For instance [212.170.180.177](#)
8. **RTP PUBLIC PORT:** parameter that will tell the Phoenix ALIO which public port will correspond to the RTP of its IP interface, so that it can send the said port in its SIP messages. The router or firewall administrator must tell you the value of this parameter in order to make the required port-forwarding. For instance: 8002

In the aforementioned note the detailed configuration and need of port-forwarding is explained.

4.3.3. AUTO 1 (local network audio).

This mode will be used primarily when two units that are in the same local network need to communicate with each other, when the Proxy SIP is on the Internet and it's the one provided by AEQ (sip.aeq.es).

4.3.4. AUTO 2 (local network audio).

This mode will be used primarily when two units that are in the same local network need to communicate with each other, when a Proxy SIP on the Internet is used, it's not the one provided by AEQ (sip.aeq.es) and only if the AUTO1 mode doesn't work properly.

4.3.5. AUTO 3 (audio over internet).

This mode will be used mainly when you wish to put two units in communication with each other through the Internet, working with no Proxy (DIRECT SIP mode) or using the Proxy SIP provided by AEQ (sip.aeq.es) (PROXY SIP mode). The two configuration parameters available on screen for this mode are:

1. **STUN SERVER:** parameter that tells the unit the STUN server that will be used. On the Internet there is multitude of public STUN servers. By default, the IP address of stun.sipgate.net server is configured: 217.10.68.152.
2. **STUN PORT:** parameter that tells the unit the STUN server port assigned by the administrator. By default: 3478.

NOTE: in this mode the Phoenix ALIO behaves in the exact same way as the Phoenix Mobile unit when it is using a STUN server.

4.3.6. AUTO 4 (audio over internet).

This mode is equivalent to AUTO3 but it will be used the SIP server is not the one provided by AEQ and there are problems with AUTO3 mode. The configuration parameters are the same as for AUTO3 (STUN server specification).

4.4. FEC modes and reception buffer configuration.

- **FEC error correction mode.** Error correction is performed by sending redundant information that allows the receiver to recompose the lost data in case of not-perfect transmissions.

Forward error correction always generates a higher binary rate, and this in turn can generate more and more losses in very narrow transmission channels, as well as delays. It is recommended that the communication is started with no FEC (OFF) and, once established, experiment with the different available modes in case of problems and check if the results are better with some of them.

- **LOWEST:** generates a 40% higher binary rate and produces a 575 ms additional delay.
 - **LOW:** generates a 50% higher binary rate and produces a 375 ms additional delay.
 - **MIDDLE:** generates a 66% higher binary rate and produces 225 ms additional delay.
 - **HIGH:** duals the binary rate producing 125 ms additional delay.
- **Adaptive / Fixed:** you can set up the **reception buffer** as adaptive or fixed. In the first case, its size will vary according to the network transmission quality. In fixed mode, its size will be steady according to manual configuration.
 - **Adaptive Buffer max/min / Fixed buffer length:** these are the maximum y minimum size of the reception buffer. When it is defined as adaptive, Phoenix ALIO will start to adjust it from these values as the network's transmission quality allows. If it is defined as FIXED, this value will remain, as the buffer's size won't be varied during the connection. This value must be set in milliseconds. The longer the buffer is, packet misses will be less likely, but base delay will also be longer, especially if the buffer is set to FIXED mode.

In order to help you select the best option for each application, we recommend to use a Fixed buffer, with a low value (around 100ms) in applications where optimal audio quality is the main concern (mainly when using PCM modes in suitably sized networks). If the received audio quality is as expected, and the network allows for it, you can continue adjusting the buffer to lower values in order to minimize delay, until you find that audio is compromised (as the buffer size reaches the network maximum jitter value). At this point, just increase the buffer a little bit to have some margin.

In high-quality PCM connections, you can start using highest quality modes (48 KHz, 24 bits, mono or stereo only if required), and if you can't obtain the desired quality and/or stability (no noises present) and good delay, you can lower quality progressively until, for example, 16 bit (CD quality audio).

On the other hand, for applications where lowest possible delay is the main goal, but transparent audio is not necessary (for example, in voice connections with commentators), it is better to select the Adaptive Buffer mode, starting from a 1000ms maximum size, approx. If the network is not too bad, the unit won't increase the buffer to highest values from the network's jitter value, and it will try to minimize delay continuously. Please not that if the network has very variable delay, the adjustments required to increase or decrease the buffer size can produce noticeable effects in the received audio, so this method is not recommended for PCM modes where maximum quality is required, in this case a fixed buffer setting is preferred, as stated above.

4.5. Coding algorithm selection.

See section 6.1.3.1 ("Coding selection") at "AEQ ControlPHOENIX" user's manual.

Although AEQ recommends the use of OPUS coding algorithms for most uses (several different modes are available to match almost any need), a coding selection window can be accessed by clicking on the "Select codec" button located inside the "ENCODER" area of the general configuration window, where both OPUS modes and others provided for compatibility can be found.

Note that the "DECODER" will be automatically configured for the same coding algorithm and mode.

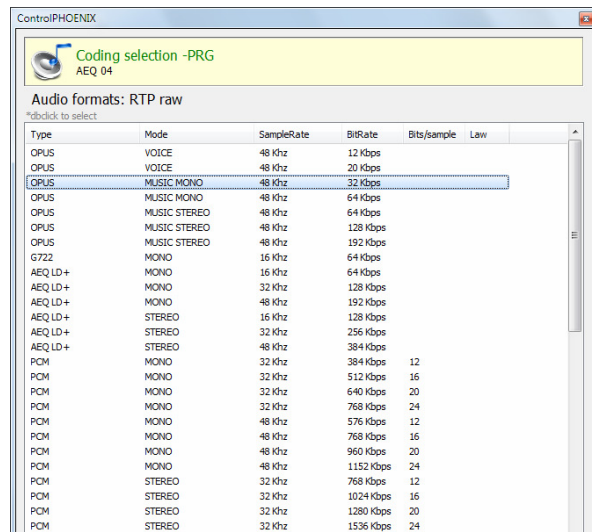

However, when the interface is IP and configured in any of the SIP modes ("DIRECT SIP" or "PROXY SIP"), particular coding algorithms won't be selected and connection "profiles" will be defined instead, containing one or more modes. This is like that because SIP allows the participants in a communication to negotiate the coding algorithm, so the one to be finally used will be limited to those included in the selected profile.

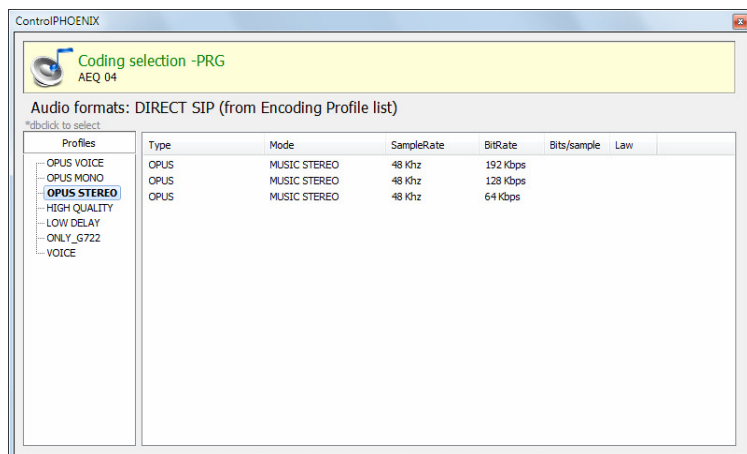

This possibility allows the configuration of the parameters associated to the coding to be used in Audio over IP networks basing on SIP protocol (Proxy SIP and Direct SIP modes). This option simplifies the selection of the algorithm to be used in a communication, because most of the codecs have several tens of encoding algorithms in order to have the higher compatibility with other equipments.

When a communication is established using SIP signaling, the codec negotiates the use of the first compatible encoding algorithm included in a list called SIP CODEC PROFILE. That's why you should put these algorithms in order of preference.

Each one of the stored entries includes an alphanumeric identifier and a list of algorithms to use, organized in order of preference. There several preset profiles in the unit, grouped by delay, quality... etc.

Profiles can be added, modified or deleted in the "Encoding Profile Management (SIP)" screen, accessible from the "Tools" menu in the upper Menu bar, described in paragraph 5.1.9 of "AEQ ControlPHOENIX" user's manual.

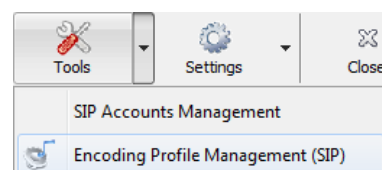

4.6. Ethernet Port configuration.

The "**Ethernet config**" menu allows you to configure the IP parameters of the Ethernet interface in the unit.

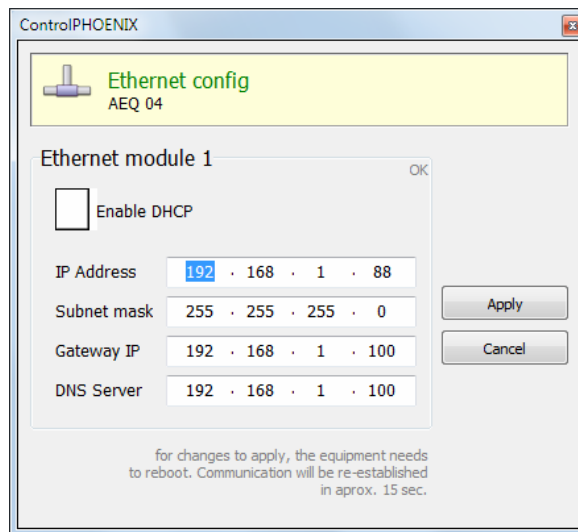

The parameters to be configured are:

- **Enable DHCP:** enables the activation or deactivation of the automatic configuration of IP addresses, masks and gateways. There must be a DHCP server in the network the unit is connected to in order to make this option work. When "Enable DHCP" is validated, the following parameters will be filled automatically; when "Enable DHCP" is not validated you will be able to change them manually.
- **IP Address:** valid IP address associated with that interface.
- **Subnet mask:** valid subnet mask associated with that interface.
- **Gateway IP:** valid gateway or network gateway address associated with that interface.
- **DNS Server:** IP address of the external addresses resolution server, valid in the geographic zone where codec is placed, or internal server (inside the local network) authorized to translate alphanumeric URL identifiers into IP addresses.

Once those parameters are configured, and after pressing the "Apply" button, a confirmation window will appear. After confirming, the equipment reboots and the communication re-establishes in approximately 15 seconds.

If you have any doubts, please consult your IT network technician or directly contact the AEQ or authorized distributors' technical support department.

4.7. SNMP configuration.

This unit can be remotely managed using SNMP (Simple Network Management Protocol) using one of the many client pieces of software available in the market, even for free. SNMP allows monitoring of the status of several pieces of equipment from very diverse manufacturers and natures, as well as elaborating reports, generate e-mail alerts, etc.

You can access the configuration menu in "Configuration" → "Network".

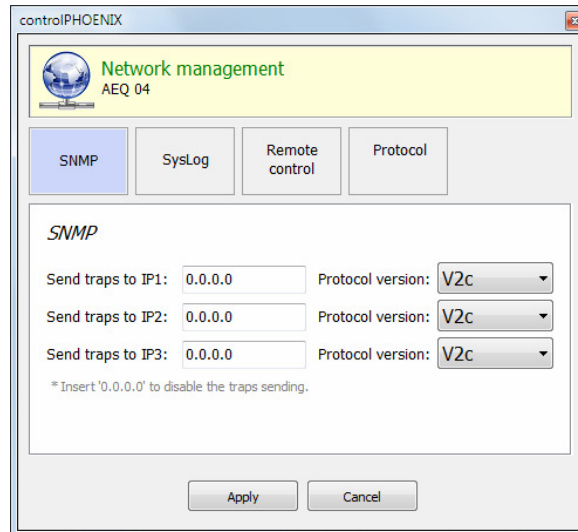

AEQ Phoenix audiocodex family can connect to **up to 3 SNMP clients**, installed in remote PCs, by simply configuring their IP addresses in the "SNMP" tab of previous menu. Once one or more SNMP clients are connected and the corresponding "MIB" descriptive file has been loaded (it can be downloaded from the equipment's Web Interface: see section 7.7 of this manual), the audiocodex will send/accept different types of information to/from each client:

1. Alarms (TRAPS): Provide information relating to certain equipment's events that can be considered as alarms. They usually have two possible states: Active or Inactive. The list of alarms defined for Phoenix ALIO is as follows:

- phxCh1NoTxAudioAlarm (Audio detection event at Channel 1's input)
- phxCh1NoRxAudioAlarm (Audio detection event at Channel 1's output)
- phxCh2NoTxAudioAlarm (Audio detection event at Channel 2's input)
- phxCh2NoRxAudioAlarm (Audio detection event at Channel 2's output)
- phxCh1NoAudioSyncAlarm (Sync event at Channel 1 while connected)
- phxCh2NoAudioSyncAlarm (Sync event at Channel 2 while connected)
- phxCh1CallEndAlarm (Call ended on Channel 1 due to incoming RTP traffic loss)
- phxCh2CallEndAlarm (Call ended on Channel 2 due to incoming RTP traffic loss)
- phxOtherAlarm (Other alarms, see name) -> Fail to register in SIP PROXY server, activation / deactivation of BACKUP interface for Ch1 and/or Ch2.
- coldStart alarm (Starting from unit off. This is a standard SNMP alarm, it appears only one time and has no activation or deactivation).

These alarms are sent whenever they change, but we can choose from the SNMP client which ones are shown / treated and which not.

The first 4 audio alarms are configurable and they are activated whenever the incoming or outgoing (depending on the particular alarm) audio level is below a certain threshold for a given time, parameters that are set either by means of the Control Phoenix software, or using the following SET commands. For example, alarm "phxCh1NoTxAudioAlarm" will become Active whenever audio from ch1 input has a level below the threshold defined by "phxCh1TxAudioThreshold" during a longer time than specified by "phxCh1TxAudioInterval".

2. Configurations (SET): adjustments related to some of the above defined alarms (the SNMP client will configure them by means of "SET" commands, although in the case of Phoenix units, they can also be modified by means of "AEQ ControlPHOENIX" remote control software):

- phxCh1TxAudioThreshold (Audio threshold for channel 1's input)
- phxCh1TxAudioInterval (Audio interval for channel 1's input)
- phxCh1RxAudioThreshold (Audio threshold for channel 1's output)
- phxCh1RxAudioInterval (Audio interval for channel 1's output)
- phxCh2TxAudioThreshold (Audio threshold for channel 2's input)

- phxCh2TxAudioInterval (Audio interval for channel 2's input)
- phxCh2RxAudioThreshold (Audio threshold for channel 2's output)
- phxCh2RxAudioInterval (Audio interval for channel 2's output)

3. Information messages (GET): showing a status, they don't arrive spontaneously or are activated/deactivated like the Alarms, but they are requested by the SNMP client by means of "GET" messages:

- phxCh1Status (Channel 1's status) --> (OK, CONNECTED, CONNECTING, DISCONNECTING, CALLING, NO LINK, REGISTER ERROR, REGISTERING, CALL ERROR)
- phxCh2Status (Channel 2's status) --> (OK, CONNECTED, CONNECTING, DISCONNECTING, CALLING, NO LINK, REGISTER ERROR, REGISTERING, CALL ERROR)
- phxCh1TxAudio (Ch1's audio input indicator status). Indicates the status of the virtual LED indicating audio presence, according to the corresponding configured parameters.
- phxCh1RxAudio (Ch1's audio output indicator status). Indicates the status of the virtual LED indicating audio presence, according to the corresponding configured parameters.
- phxCh2TxAudio (Ch2's audio input indicator status). Indicates the status of the virtual LED indicating audio presence, according to the corresponding configured parameters.
- phxCh2RxAudio (Ch2's audio output indicator status). Indicates the status of the virtual LED indicating audio presence, according to the corresponding configured parameters.
- phxCh1OnAir (Ch1's ON AIR option activated or not)
- phxCh2OnAir (Ch2's ON AIR option activated or not)
- phxCh1Synced (Ch1's audio synchronized or not)
- phxCh2Synced (Ch2's audio synchronized or not)
- phxCh1BackupInterfaceActive (Whether or not Ch1's backup interface is being used on a call)
- phxCh2BackupInterfaceActive (Whether or not Ch2's backup interface is being used on a call)
- mib2.system (sysUpTime, sysContact, sysDescr, sysServices,...): Standard SNMP commands indicating things such as equipment's turn on time, etc. For more information, please check MIB-II specification in RFC1213 (<http://tools.ietf.org/html/rfc1213>)

For more information, please consult section 7.7 of this manual and section 6.5.1 of "AEQ ControlPHOENIX" application manual.

4.8. Password configuration.

Version **2.2.1.1** (or higher) of the application allows you to configure for the unit a numerical **password** of up to 4 digits by clicking on "User Password" checkbox (in "Remote Control" tab of "Network management" menu).

That password will be requested whenever you try to **add** the unit to the application, whether it's done by autodiscovery or manually (once the unit is added, the password won't be requested again although you close and reopen the application, but it will be requested if you delete the unit and try to add it again or if you add it from another PC where the application is also installed).

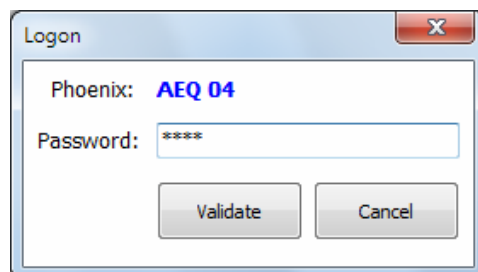

For more information, please consult section 6.5.3 of "AEQ ControlPHOENIX" application manual.

4.9. User interface lock.

From CPU version **6.80**, it is possible to lock certain functions of the user panel from "**AEQ ControlPHOENIX**" software (version **2.2.1.20** or higher). The only way to recover local control on the disable functions is to connect to the unit from the application and re-enabling them.

When you try to access to a locked function, the display will show the following indication for a few seconds:



By means of "**User Interface permissions**" option of "**Miscellaneous**" window (see section 6.4.8 of "AEQ ControlPHOENIX" user's manual), the window that allows you to enable/disable those permissions will be accessed:

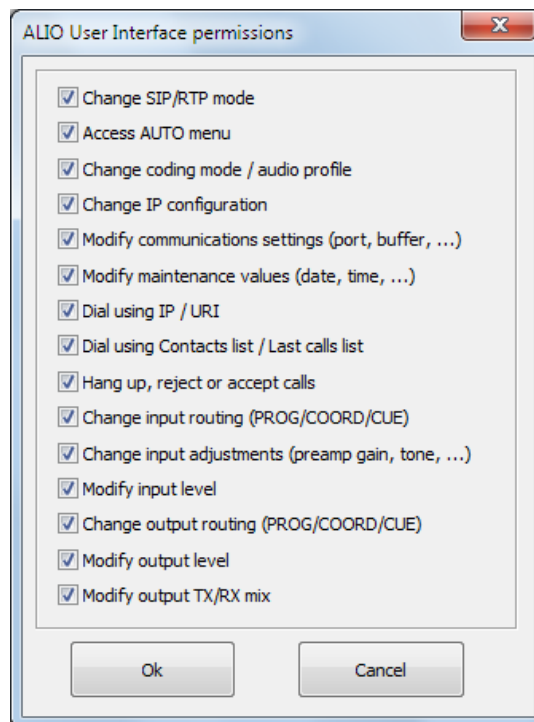

All the permissions are active by default. In order to deactivate any of those permissions, locking the associated function of the unit's user interface, you just have to deselect the corresponding checkbox and press "Ok". In order to reactivate any of them, you just have to select the corresponding checkbox and press "Ok".

These settings are stored on the device, so if it is controlled from another PC, they will still apply.

These are the groups of actions that can be enabled/disabled:

- "**Change SIP/RTP mode**": allows or forbids the user to change between RTP, Direct SIP and Proxy SIP operating modes using the "IP" and "SIP" keys.
- "**Access AUTO menu**": allows or forbids the user access to the call automation functions ("SmartRTP", "AutoAnswer", "Auto Hang-Up", etc.) using the "AUTO" key.

- **"Change coding mode / audio profile"**: allows or forbids the user to change the encoding mode for next call (or the profile, when operating in SIP modes) using the "CODEC" key. However, the actual coding for the selected channel can always be checked by means of a long press on that key.
- **"Change IP configuration"**: allows or forbids the user to change the unit's IP address, mask, gateway or DNS, as well as changing from manual to DHCP mode or vice-versa ("ETHERNET" submenu options).
- **"Modify communications settings (port, buffer, ...)"**: allows or forbids the user to alter certain communication parameters such as the kind and size of the receiving buffer, local RTP port, SIP parameters, etc. ("COMMUNICATIONS" submenu options).
- **"Modify maintenance values (date, time, ...)"**: allows or forbids the user to alter certain parameters such as date and time, activate loops or test tones, etc. ("MAINTENANCE" submenu options).
- **"Dial using IP / URI"**: when activated, the local user can make calls by manually dialing <IP:Port> pair or a URI (when operating in SIP modes). Otherwise, calls can only be made from the agenda or calls history list (provided that next option is enabled).
- **"Dial using Contacts list / Last calls list"**: when activated, the local user can make calls by selecting a contact from the agenda or a call from the calls history. If the former option is also disabled, the user cannot make calls from the front panel (but he/she will be able to answer incoming calls and, in any case, calls can be sent from "AEQ ControlPhoenix" application by a remote operator).
- **"Hang up, reject or accept calls"**: allows or forbids the user to hang up, reject or accept calls from the unit's interface.
- **"Change input routing (PROG/COORD/CUE)"**: allows or forbids the user to change which bus each input is routed to (PROG / COORD / CUE) by means of the corresponding "ON" key. The restriction affects all 4 inputs.
- **"Change input adjustments (preamp gain, tone, ...)"**: allows or forbids the user to make adjustments on the configuration of any of the 4 inputs, such as preamp. gain, equalization, Phantom power supply or shift from line to mic (adjustments accessed by pressing the corresponding encoder).
- **"Modify input level"**: allows or forbids the user to modify the send level of the inputs by turning the associated rotary encoder.
- **"Change output routing (PROG/COORD/CUE)"**: allows or forbids the user to change the audio source for the headphone / line outputs by pressing the associated encoder.
- **"Modify output level"**: allows or forbids the user to change the headphone and line output level by turning the associated rotary encoder.
- **"Modify output TX/RX mix"**: allows or forbids the user to adjust the ratio of transmission and reception of the corresponding output by turning the associated TX/RX potentiometer.

5. QUICK USER'S GUIDE. LOCAL OPERATION.

In order to deeply know the operation of Phoenix ALIO unit, it is **strongly recommended** that the previous chapters are thoroughly read. In this chapter the basic actions to **manually** operate the unit are described. If more detail is needed, please check the information provided in the previous chapters.

5.1. Connecting the unit.

5.1.1. Power supply.

Power supply to the unit is provided by the provided AC/DC adapter unit or by means of a homologated UPS. In any case, connection to the unit is made by means of the special latching connector at the back as described in chapter 2.2.3 of this manual.

5.1.2. Audio.

Chapter 2 in this manual describes the physical connections present in the back and side panels of the audiocodec in detail, but in a nutshell, this is the simplified procedure:

- Connect the required microphones to inputs MIC1 to MIC4 at the back panel.
- Select an adequate gain (usually around 40dB) using each input's configuration menu, accessible by simply pressing the corresponding encoder button (MIC1-MIC4/LINE).
- Activate Phantom supply where necessary (check the microphone manual).
- If required, connect the line input source to the XLR connectors at the right side of the unit labeled as IN (L & R).
- Connect one or two headphones to the HP1 and/or HP2 outputs at the right side of the unit.
- If required, connect the line output to the XLR connectors at the right side of the unit labeled as OUT (L & R).

5.1.3. Communications interface.

- Connect an Ethernet cable (CAT5 or better) finished in an RJ45 10/100 BT to the LAN connector provided at the unit's back panel. The selected cable must be straight when the connection is made from the unit to a communications device (switch, router...). For more information about the pinout of this port please check section 2.2.2 of this manual. The **default IP address** for PHOENIX ALIO is **192.168.1.88**.

5.2. Turning the unit on.

- Once the unit is connected to the power supply through its adapter, the OLED screen will turn on after around **15 seconds***, showing AEQ logo and the audiocodec model name.
- Check that audio routing and levels are correct; if they are not, just operate the controls to establish the desired configuration.
- The unit is ready to be used.

* The "ESC / DEL" key (with a red telephone) will light in red for around 15 seconds when the unit is turned on, until the welcome screens appear.

5.3. Establishing a communication.

Several operating modes are available, depending on the protocol used for the communication initiation.

The simplest –yet still very effective- mode, that we recommend for a start, is IP mode (RTP Raw) with the "**SmartRTP**" option activated (this option can be found under the AUTO menu), as it will be adequate for most cases, together with the OPUS family of encoding algorithms.

When operating with audiocoders from other manufacturers, you can use either IP mode without "**SmartRTP**" (almost every codec out there can operate in RTP mode) or, alternatively, a SIP-based mode. When the IP address of the counterpart unit is not known (mobile connections, dynamic IP, etc) the PROXY SIP mode is recommended, as it relies on an external server to resolve IP addresses. On the other hand, if IP and ports are well-defined, it is better to use DIRECT SIP. Select any of the N/ACIP recommended encoding algorithms, such as G722 or MPEG-1 /2, depending on the quality required, acceptable delay and available bandwidth.

5.3.1. Establishing an IP communication in RTP mode using **SmartRTP**.

- Check that the unit is ON.
- Check that the RJ45 cable is connected and latched.
- Check that the amber LED, integrated in the RJ45 port, is flashing.
- Verify the status of the communications interface. Activate the "IP" button, which will remain steadily illuminated. If it blinks, there is some problem with the Ethernet connection (or there is no IP configuration after activating DHCP option) and the unit won't allow you to make calls.
- Press the "AUTO" button and make sure that "**SmartRTP**" option is activated.
- Establish the desired audio configuration (inputs routing, mix level, MIC4 / LINE IN mode, and outputs).
- If the coordination channel license is activated, select the channel we want to call from by means of the "NAVI / Ch" button. The corresponding legend will get illuminated between the vumeters (**PROG** or **COORD**).
- Configure the coding algorithm according to the desired quality and network capabilities by pressing the "**CODEC**" button. Choosing one of the OPUS modes included in the unit is recommended, depending on the communication needs (voice, mono music, stereo music) and network connection quality.
- Press the "**OK**" button. The numeric keyboard will become illuminated in a colour that depends on the active channel: red (PROGRAM) or green (COORDINATION).
- Using the "NAVI / Ch" encoder, select whether you want to call from an agenda contact (CONTACT LIST), select one of the LAST CALLS or manually dial an IP / Port. If manual mode is selected, go to the "IP" line and fill the numbers moving the encoder and confirming each one by means of its pushbutton:

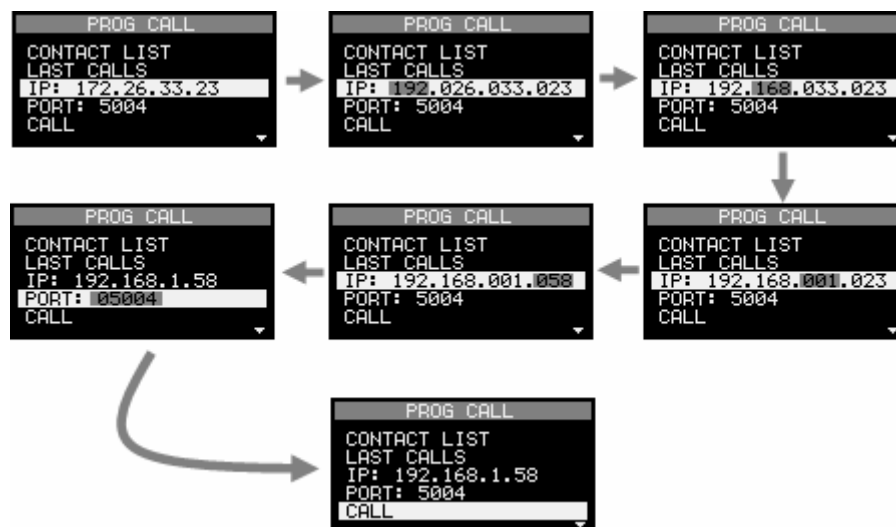

Alternatively, you can directly dial the IP address, always typing 3 digits per number, and confirming each number with the "NAVI / Ch" button.

For example: If you want to call to IP 192.26.5.12, just type:

"1", "9", "2", (NAVI/Ch button), "0", "2", "6", (NAVI/Ch button), "0", "0", "5", (NAVI/Ch button), "0", "1", "2", (NAVI/Ch button to finish).

- Go to next line, "PORT", and select the destination port, either with the encoder (they change in steps of 4) or typing it (always with 5 digits).
- Select the "CALL" option or press the "OK" key again.
- Repeat the audio and mode configuration process in the other end. As "**SmartRTP**" option is active, the other codec will automatically connect as soon as it starts receiving RTP traffic, and so there will be no need to dial IP addresses or ports, accept the incoming call or even configuring the encoding algorithm.
- The OLED screen displays the call status, as well as the destination IP and port:
 - **CONNECTING:** The "OK" key will blink when in this status.



- **CONNECTED / NO SYNC / NO DATA:** When the call has been successfully established, data is received but synchronization to it is not possible, or no data at all is received, respectively. The "OK" key will remain steadily illuminated.



If status is NO SYNC or NO DATA and auto-hang up option is enabled, the call will be rejected after the defined time, and the "OK" key illumination will turn off.

Once connected with the remote end, verify that the vumeters in Phoenix ALIO front panel show the presence of send and received audio, and adjust levels as necessary.

5.3.1.1. Ending an IP communication in RTP mode.

- In order to finish the communication, just press the "ESC / DEL" key for a longer time, making sure that the currently selected channel is the one we want to cut. If, as recommended, "**SmartRTP**" is activated in both codecs involved, there is no need to repeat the hang up process in the remote end. The "ESC / DEL" key will blink red during disconnection, and the display will show the "DISCONNECTING" status. Both will disappear only when the call has been completely disconnected.



5.3.2. Establishing an IP call in PROXY SIP mode.

When, for instance, due to compatibility issues with other manufacturers, SIP signaling is required, relying on an external server to abstract from involved IP, ports, etc., the PROXY SIP mode will be used:

- Check that the unit is ON.
- Check that the RJ45 cable is connected and latched.
- Check that the amber LED, integrated in the RJ45 port, is flashing.
- Establish the desired audio configuration (inputs routing, mix level, MIC4 / LINE IN mode, and outputs).
- If the coordination channel license is activated, select the channel we want to call from by means of the "NAVI / Ch" button. The corresponding legend will get illuminated between the vumeters (**PROG** or **COORD**).
- Press the "**SIP**" key until "PROG/COORD CHANNEL - PROXY SIP MODE" is displayed. Press the "**MENU**" key and select "COMMUNICATIONS". Under "SIP" menu, verify that a valid PROVIDER is selected, a valid user is entered and the password is correct; in case they are not, you can edit them (once all is filled in, confirmation is provided by pressing the "NAVI / Ch" button, or cancelled with a long pressing of "ESC / DEL" key; the cursor can be moved using the "NAV / Ch" encoder and characters are erased with "ESC / DEL" key).
- Select a valid SIP PROVIDER (that must have been previously stored in the unit using the remote control software); the default provider is "AEQ", but up to 8 definitions can be saved.
- Verify the status of the communications. Check that the "SIP" key is steadily illuminated. If there is some problem with the Ethernet connection, the access or registration on the Proxy server or there is no IP configuration after activating DHCP option, then the key blinks and the unit won't allow you to make any calls. If this is the case, check connectivity and configuration under the ETHERNET, SIP and NAT menus carefully (all of them accessibly with the "**MENU**" key).
- Select a coding profile according to the desired quality and network capabilities by pressing the "**CODEC**" button.
- Establish the desired automatic options (Auto Answer, auto-hang up and permanent call) by means of the "**AUTO**" button.
- Press the "**OK**" button. The numeric keyboard will become illuminated in a colour that depends on the active channel: red (PROGRAM) or green (COORDINATION).
- Using the "NAVI / Ch" encoder, select whether you want to call from an agenda contact (CONTACT LIST), select one of the LAST CALLS or just type it in manually (URI):

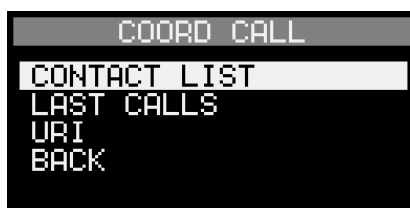

When typing the URI manually, the cursor can be moved by means of the "NAVI / Ch" encoder and characters at its left can be erased with the "ESC / DEL" key. The (*) key shifts the writing mode between numbers (123), lower case (abc) or capitals (ABC). This latest mode is useful to type IP addresses. In alphanumeric mode, the "1" key allows for the insertion of several symbols (@, -, _, ., :).

Once the URI is typed in, press the "**OK**" key to confirm or press the "**ESC / DEL**" key for a **longer time** to cancel.

The URIs must be specified according to one of the following formats:

- <dest_URI> i.e: phoenixMaster
- <dest_URI>@<PROXY_domain> i.e: phoenixMaster@sip.aeq.es
- <dest_URI>@<PROXY_IP> i.e: phoenixMaster@232.168.1.2
- <dest_URI>@<PROXY_domain>:<SIP port> i.e:
phoenixMaster@sip.aeq.es:5060

- Select the "CALL" option or press the "OK" key again.
- Accept, if necessary, the call in the other end (see 5.3.2.2).
- The OLED screen displays the call status, as well as the destination URI address:
 - **CONNECTING** (depending on the communication interface and the network status, this one could be an extremely brief status): The "OK" key will blink during this time.
 - **CONNECTED / NO SYNC / NO DATA:** When the call has been successfully established, data is received but synchronization to it is not possible, or no data at all is received, respectively. The "OK" key will remain steadily illuminated.

If status is NO SYNC or NO DATA and auto-hang up option is enabled, the call will be rejected after the defined time, and the "OK" key illumination will turn off.

Once connected with the remote end, verify that the vumeters in Phoenix ALIO front panel show the presence of send and received audio, and adjust levels as necessary.

The LAST CALLS option displays a list with the latest successful OUTGOING or INCOMING CALLS. Additional information (date, time...) can be obtained by pressing the "NAVI / Ch" button on each entry. The most recent calls are displayed on top. Both lists can be deleted by using the DELETE LAST CALLS option.



5.3.2.1. Ending an IP call in PROXY SIP mode.

- In order to finish the communication, just press the "ESC / DEL" key for a longer time, making sure that the currently selected channel is the one we want to cut. The "ESC / DEL" key will blink red during disconnection, and the display will show the "DISCONNECTING" status. Both will disappear only when the call has been completely disconnected.

5.3.2.2. Receiving and accepting an IP call in PROXY SIP mode.

If the unit interface is correctly configured and the Autoanswer mode is not active (**AUTO → AUTOANSWER OFF**), when a call is received:

- As opposed to "**SmartRTP**" mode, incoming SIP calls ARE signaled, and unless the Autoanswer option is enabled, the user can decide whether to accept or reject the call by means of the "OK" / "ESC/DEL" keys. The unit will emit an acoustic signal. It can, however, be disabled under the **MENU → MAINTENANCE → BUZZER** menu. The "OK" key will simultaneously blink to warn the user.
- Information about the caller will appear in the OLED screen, indicating the channel (PROGRAM or COORDINATION) where the call is coming to.
- The user can accept the call by pressing the "OK" key, or reject it by pressing the "ESC / DEL" key (assuming that Autoanswer option is not enabled).
- If the call is accepted, call status is displayed:
 - **CONNECTING** (depending on the communication interface and the network status, this one could be an extremely brief status): The "OK" key will blink during this time.
 - **CONNECTED / NO SYNC / NO DATA:** When the call has been successfully established, data is received but synchronization to it is not possible, or no data at all is received, respectively. The "OK" key will remain steadily illuminated.

If status is NO SYNC or NO DATA and auto-hang up option is enabled, the call will be rejected after the defined time, and the "OK" key illumination will turn off.

Once connected with the remote end, verify that the vumeters in Phoenix ALIO front panel show the presence of send and received audio, and adjust levels as necessary.

5.3.3. Establishing an IP call in DIRECT SIP mode.

This mode is simply a variation of PROXY SIP, using the same signaling and call establishment protocol, but without the aid of an external server, so that the destination IP needs to be known. Note that since "SmartRTP" mode is offered in Phoenix audiocoders, the DIRECT SIP mode doesn't offer obvious functional advantages, so its use will be typically relegated to cases where operation against third-party or older units is required.

- Check that the unit is ON.
- Check that the RJ45 cable is connected and latched.
- Check that the amber LED, integrated in the RJ45 port, is flashing.
- Establish the desired audio configuration (inputs routing, gains, mix levels, MIC4 / LINE IN mode, and outputs).
- If the coordination channel license is activated, select the channel we want to call from by means of the "NAVI / Ch" button. The corresponding legend will get illuminated between the vumeters (**PROG** or **COORD**).
- Press the "SIP" key until "PROG/COORD CHANNEL - DIRECT SIP MODE" is displayed. Press the "MENU" key, select "COMMUNICATIONS" and verify that the involved channel has been assigned a correct URI name. You can edit that name (confirmation is provided by pressing the "NAVI / Ch" button, or cancelled with a long pressing of "ESC / DEL" key; the cursor can be moved using the "NAV / Ch" encoder and characters are erased with "ESC / DEL" key).
- Verify the status of the communications. Check that the "SIP" key is steadily illuminated. If it blinks, there is some problem with the Ethernet connection (or there is no IP configuration after activating DHCP option) and the unit won't allow you to make calls. If this is the case, check connectivity and configuration under the ETHERNET and NAT menus carefully (all of them accessibly with the "MENU" key).
- Select a coding profile according to the desired quality and network capabilities by pressing the "CODEC" button.
- Establish the desired automatic options (Auto Answer, auto-hang up and permanent call) by means of the "AUTO" key.
- Press the "OK" button. The numeric keyboard will become illuminated in a colour that depends on the active channel: red (PROGRAM) or green (COORDINATION).
- Using the "NAVI / Ch" encoder, select whether you want to call from an agenda contact (CONTACT LIST), select one of the LAST CALLS or just type it in manually (URI):



When typing the URI manually, the cursor can be moved by means of the "NAVI / Ch" encoder and characters at its left can be erased with the "ESC / DEL" key. The (*) key shifts the writing mode between numbers (123), lower case (abc) or capitals (ABC). This latest mode is useful to type IP addresses. In alphanumeric mode, the "1" key allows for the insertion of several symbols (@, -, _, ., :).

Once the URI is typed in, press the "OK" key to confirm or press the "ESC / DEL" key for a **longer time** to cancel.

The URIs must be specified according to one of the following formats:

- <dest_URI>@<dest_IP> i.e: phoenixMaster@172.26.33.15
- <dest_URI>@<dest_IP>:<SIP_port> i.e:
phoenixMaster@172.26.33.15:5061
- Select the "CALL" option or press the "OK" key again.
- Accept, if necessary, the call in the other end (see 5.3.3.2).
- The OLED screen displays the call status, as well as the destination URI address:
 - **CONNECTING** (depending on the communication interface and the network status, this one could be an extremely brief status): The "OK" key will blink during this time.
 - **CONNECTED / NO SYNC / NO DATA:** When the call has been successfully established, data is received but synchronization to it is not possible, or no data at all is received, respectively. The "OK" key will remain steadily illuminated.

If status is NO SYNC or NO DATA and auto-hang up option is enabled, the call will be rejected after the defined time, and the "OK" key illumination will turn off.

Once connected with the remote end, verify that the vumeters in Phoenix ALIO front panel show the presence of send and received audio, and adjust levels as necessary.

The LAST CALLS option displays a list with the latest successful OUTGOING or INCOMING CALLS. Additional information (date, time...) can be obtained by pressing the "NAVI / Ch" button on each entry. The most recent calls are displayed on top. Both lists can be deleted by using the DELETE LAST CALLS option.



5.3.3.1. Ending an IP call in DIRECT SIP mode.

- In order to finish the communication, just press the "ESC / DEL" key for a longer time, making sure that the currently selected channel is the one we want to cut. The "ESC / DEL" key will blink red during disconnection, and the display will show the "DISCONNECTING" status. Both will disappear only when the call has been completely disconnected.

5.3.3.2. Receiving and accepting an IP call in DIRECT SIP mode.

If the unit interface is correctly configured and the Autoanswer mode is not active (**AUTO → AUTOANSWER OFF**), when a call is received:

- As opposed to "**SmartRTP**" mode, incoming SIP calls ARE signaled, and unless the Autoanswer option is enabled, the user can decide whether to accept or reject the call by means of the "OK" / "ESC/DEL" keys. The unit will emit an acoustic signal. It can, however, be disabled under the **MENU → MAINTENANCE → BUZZER** menu. The "OK" key will simultaneously blink to warn the user.
- Information about the caller will appear in the OLED screen, indicating the channel (PROGRAM or COORDINATION) where the call is coming to.
- The user can accept the call by pressing the "OK" key, or reject it by pressing the "ESC / DEL" key (assuming that Autoanswer option is not enabled).
- If the call is accepted, call status is displayed:

- **CONNECTING** (depending on the communication interface and the network status, this one could be an extremely brief status): The "OK" key will blink during this time.
- **CONNECTED / NO SYNC / NO DATA:** When the call has been successfully established, data is received but synchronization to it is not possible, or no data at all is received, respectively. The "OK" key will remain steadily illuminated.

If status is NO SYNC or NO DATA and auto-hang up option is enabled, the call will be rejected after the defined time, and the "OK" key illumination will turn off.

Once connected with the remote end, verify that the vumeters in Phoenix ALIO front panel show the presence of send and received audio, and adjust levels as necessary.

6. QUICK START GUIDE. REMOTE CONTROL.

In order to gain a complete knowledge of the operation of Phoenix ALIO, we **recommend** reading the previous chapters and "AEQ ControlPHOENIX" user's manual carefully. The paragraphs below describe the basic actions you will need to take for **remote** operation of the equipment by means of "AEQ ControlPHOENIX" application.

6.1. Equipment connections.

6.1.1. Power supply.

Power supply to the unit is provided by the provided AC/DC adapter unit or by means of a homologated UPS. In any case, connection to the unit is made by means of the special latching connector at the back as described in chapter 2.2.3 of this manual.

6.1.2. Communications interface.

Connect an Ethernet cable (CAT5 or better) finished in an RJ45 10/100 BT to the LAN connector provided at the unit's back panel. The selected cable must be straight when the connection is made from the unit to a communications device (switch, router...). For more information about the pinout of this port please check section 2.2.2 of this manual.

6.2. Turning the unit on.

- Once the unit is connected to the power supply through its adapter, the OLED screen will turn on after around **15 seconds***, showing AEQ logo and the audiocodec model name.
- Check that audio routing and levels are correct; if they are not, just operate the controls to establish the desired configuration.
- The unit is now ready to be remotely controlled.

* The "ESC / DEL" key (with a red telephone) will light in red for around 15 seconds when the unit is turned on, until the welcome screens appear.

6.3. Setting up a computer to control the unit.

Connect to the same network a computer with "AEQ ControlPHOENIX" software installed with version **2.2.1.50** or higher. Follow what's indicated in chapter 3 of the application's user manual.

Check that your PHOENIX ALIO is automatically discovered after launching the application, according to chapter 4.1 of the software user's manual. Accept the unit and, if you don't find it, please check that the network parameters of both the unit and the computer belong to the same network having in mind the default IP address of the unit (IP: **192.168.1.88**, Mask: 255.255.255.0, GWAY=192.168.1.1, DNS=8.8.8.8). Keep in mind that, in order to find it with version **2.2.1.50** (or higher), the unit's CPU version must be **5.50** or higher.

The codec is ready to be controlled when the individual codec control window appears, showing "OK" label in PRG and CRD status areas and, below, the equipment's given name ("AEQ 04" in the example below).

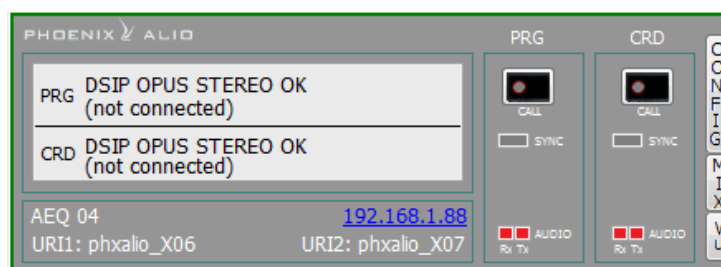

IMPORTANT NOTE: If more new codecs will be controlled in the same network, you need to change their IP address one by one as you add them in order to avoid conflicts in the network, as they will also have the same default IP addresses. Go to "Configuration" → "Ethernet" to access the dialog that allows you to change the IP parameters of the unit.

6.4. Audio.

Chapter 2 in this manual describes the physical connections present in the back and side panels of the audiocodec in detail, but in a nutshell, this is the simplified procedure:

- Connect the required microphones to inputs MIC1 to MIC4 at the back panel.
- Select an adequate gain (usually around 40 dB) using each input's configuration menu, accessible by simply pressing the corresponding encoder button (MIC1-MIC4/LINE).
- Activate Phantom supply where necessary (check the microphone manual).
- If required, connect the line input source to the XLR connectors at the right side of the unit labeled as IN (L & R).
- Connect one or two headphones to the HP1 and/or HP2 outputs at the right side of the unit.
- If required, connect the line output to the XLR connectors at the right side of the unit labeled as OUT (L & R).

6.5. Establishing an IP communication.



As explained in previous chapters, several operating modes are available, depending on the protocol used for the communication initiation.

In order to ease the task, AEQ has developed the proprietary "**SmartRTP**" protocol, that allows for the establishment of a communication without having to dial from both ends and without worrying about the coding algorithms matching, as the calling end will provide all the necessary signaling to its counterpart, so it knows what IP address and port to send the return audio to. This functionality is, in some sense, similar to the one provided by DIRECT SIP, but without renouncing to RTP inherent simplicity (all other modes are based on RTP, indeed) and without the need for additional special control ports.

In order to activate "**SmartRTP**", press the "AUTO" key and enable this option.

6.5.1. Establishing an IP communication in RTP mode using **SmartRTP**.

- Ensure that the equipment is powered up and controlled by the software.
- Establish the appropriate audio configuration (mixer).
- Check that there is incoming audio to the channel (PROG or COORD) that we are going to use to establish the communication: the "Tx" indicator in the individual codec control

window , in the general configuration screen  and in the list view  will change to green.

- Go to general configuration screen and configure "INTERFACE" as "RTP raw".

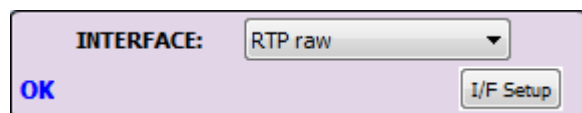

- Enter "I/F Setup" and select the "Local media port": local IP port through which the RTP audio is received. Ensure that the remote unit, when calling, sends audio to that port (see section 4.2.1).

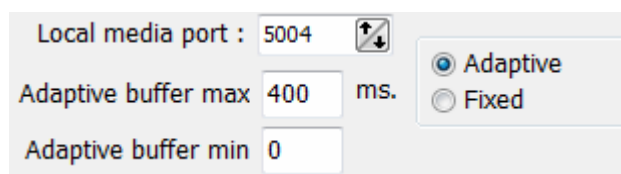

The same screen allows you to configure the type and size of the receiving buffer and FEC parameters as a function of the IP network quality so we have the shortest delay while audio cuts are minimized or eliminated in poor quality networks (see paragraph 4.4 of this manual in order to select the optimal buffer configuration depending on your application).

- Return to the general configuration screen, check that the selected coding algorithm in the green "ENCODER" area corresponding to that channel (PROG or COORD) is correct, or otherwise click on "Select codec" to change it.

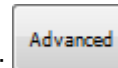
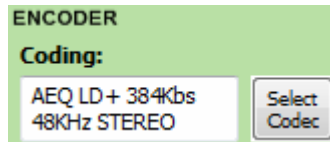

- Decide whether you will use the advanced automatic connection options or not:
 - "**SmartRTP**": Activate this option.
 - "Auto hang-up": Automatic hang-up whenever audio packets are missed for a given time.
 - "Permanent call": The device will do what's necessary to keep the call up, even after a line drop or mains cut. When "**SmartRTP**" mode is active, it is recommended that this option is enabled in the calling end only.

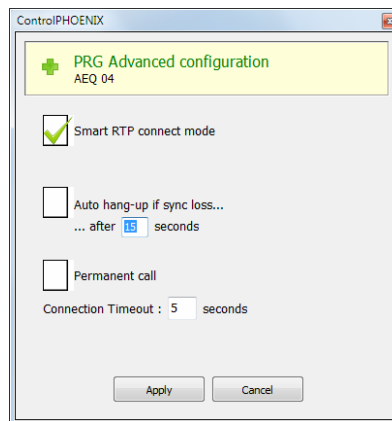

- Return to the individual codec control window and click on "**CALL**" button of the desired channel, showing then the call screen:



Enter the IP address of the remote unit, either manually or getting it from the buttons:

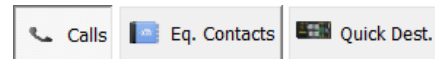
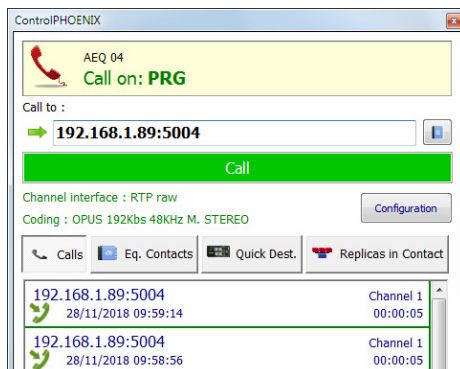

By clicking here, the last completed calls ("Calls") the contacts stored in the call book ("Eq. Contacts") or the reachable IP units ("Quick Dest.") are shown respectively, but only those configured with formats compatible with channel and communication type.

- Repeat the audio and mode configuration in the other end. As "**SmartRTP**" is enabled, the other codec will automatically connect as soon as it starts receiving audio traffic, so it won't be necessary to set the coding mode, dial IP addresses or ports, etc. nor even accept the incoming call.

- Press the green "Call" button on the screen, to make the call.
- You can monitor the status of the call on the screen:
 - **CALLING**
 - **CONNECTING**
 - **SYNCHRONIZING**
 - **CONNECTED [-NO_DATA / -NO_SYNC]**
- Verify that the "SYNC" LED beneath the "CALL" button is lighted in green to indicate that the communication has been successfully established.
- Once the connection has been established with the remote end, confirm the presence of transmitted and received audio by checking the audio presence indicators "Tx" and "Rx".



NOTE: In order to make calls to **multiple destinations**, please consult section 4.2.4 of this manual.

6.5.1.1. Ending an IP communication in RTP mode.

- To finalize the communication, simply press the "CALL" button in the individual codec control window and then confirm. As "SmartRTP" mode is active, it won't be necessary to manually terminate the call at the remote end.

6.5.2. Establishing an IP call in PROXY SIP mode.

- Ensure that the equipment is powered up and controlled by the software.
- Establish the appropriate audio configuration (mixer).
- Check that there is incoming audio to the channel (PROG or COORD) that we are going to use to establish the communication: the "Tx" indicator in the individual codec control

window , in the general configuration screen  and in the list view  will change to green .

- Go to general configuration screen and configure "INTERFACE" as "SIP, Proxy based".

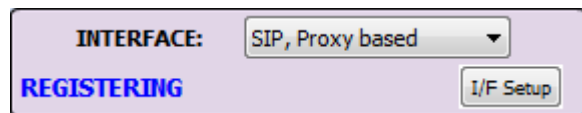

- Enter "I/F Setup" and click on "SIP Parameters".

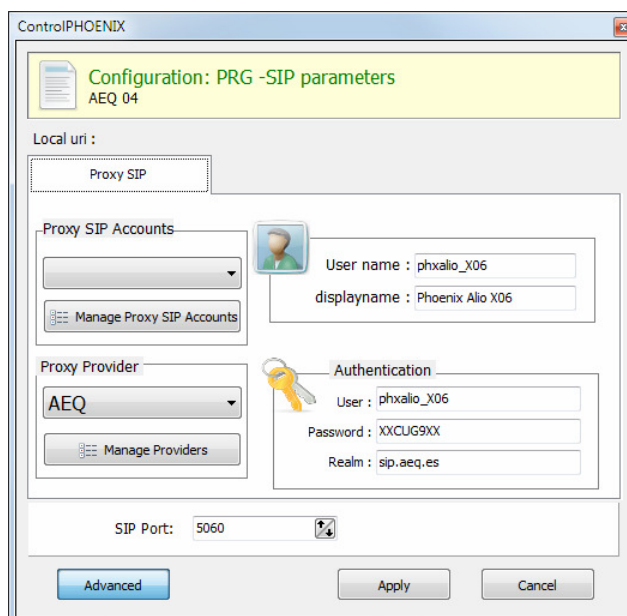

Check the SIP server configuration ("Proxy Provider"). Select one that is already configured from the list, for example the default "AEQ", or otherwise go to "Manage Providers", create a "New provider" and fill in the following fields: name, port, address of the server (either its IP or URL), SIP interface and, if necessary, check the "Register" field. In this case, you also need to re-write the "Authentication" data in the channel's SIP parameters so they match those in the new server, as the ones by default are only for "AEQ". Note that, in case you specify the SIP Server by its URL instead of its IP address, the DNS Server must be correctly configured and reachable (at "Configuration" → "Ethernet").

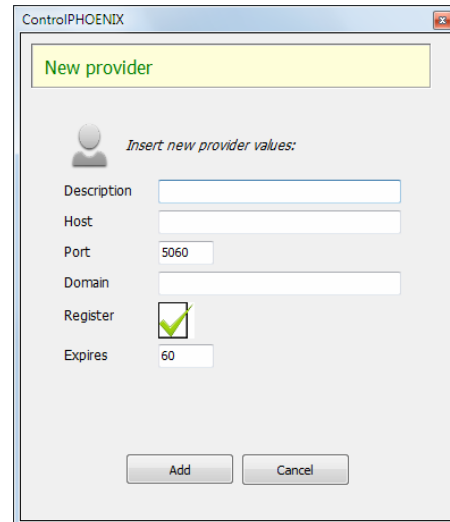

You can also select a SIP account from a previously created and stored list by means of the drop-down menu "Proxy SIP Accounts". See section 5.1.7.1 of "AEQ ControlPHOENIX" user's manual.

- Select the working mode to traverse NAT devices ("**NAT Traversal**") that is more adequate for the network the unit is connected to.

NOTE: It is recommended that you follow Application Notes 0-A or 0-C, according to the type of equipment's connection.

At "I/F Setup" fill in the "Local media port" (where the unit expects to receive RTP audio traffic at). If you enable Symmetric RTP mode, the unit will send audio to the same port where it is receiving it from. This is sometimes useful to overcome NAT routers.

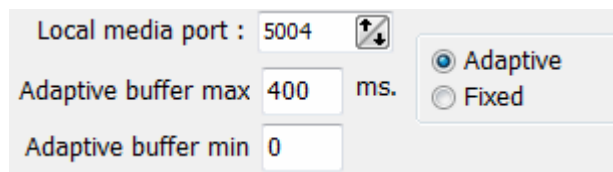

The same screen allows you to configure the type and size of the receiving buffer and FEC parameters as a function of the IP network quality so we have the shortest delay while audio cuts are minimized or eliminated in poor quality networks (see paragraph 4.4 of this manual in order to select the optimal buffer configuration depending on your application).

- Return to the general configuration screen, check that the selected encoding profile in the green "ENCODER" area corresponding to that channel (PROG or COORD) is correct, or otherwise click on "Select codec" to change it. There are several pre-defined profiles containing several particular algorithms each one, with preference ordering. They can be edited and more profiles can be added. The called unit will accept the call using the first coding algorithm that it supports from the list (independently of the profile selected in that unit at that time).

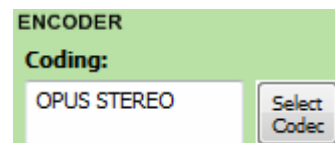

- Decide whether you will use the advanced automatic connection options or not: 
 - "Autoanswer": Automatic call answering for all incoming calls, or only those corresponding to a predefined caller.
 - "Auto hang-up": Automatic hang-up whenever audio packets are missed for a given time.
 - "Permanent call": The device will do what's necessary to keep the call up, even after a line drop or mains cut.
 - "Apply audio profile to incoming calls": allows you to filter the SIP calls depending on the encoding profile of the receiver.

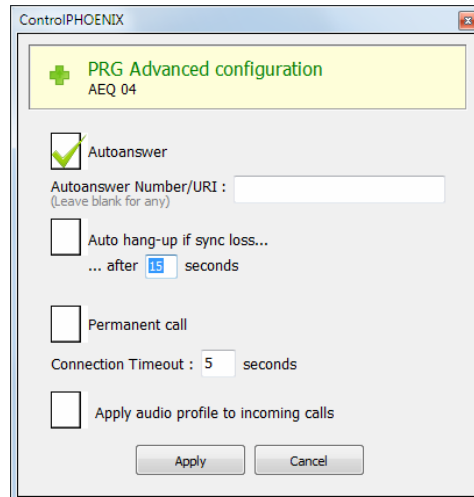

- Return to the individual codec control window and click on **"CALL"** button corresponding to that channel, showing then the call screen:

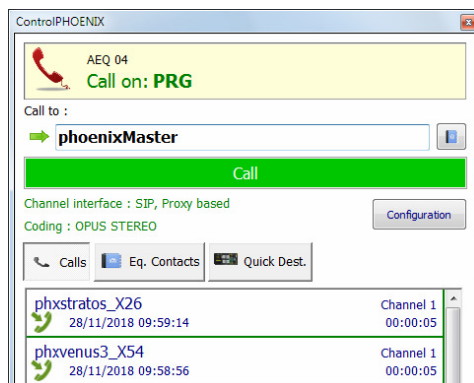

Enter the IP address of the remote unit, either manually or getting it from the buttons:

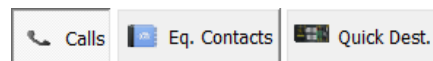

By clicking here, the last completed calls ("Calls") the contacts stored in the call book ("Eq. Contacts") or the reachable IP units ("Quick Dest.") are shown respectively, but only those configured with formats compatible with channel and communication type.

- It is mandatory that the called unit URI is specified in any of the following formats, adequate for Proxy SIP communications:
 - <equipment's_name>, for example: "phxalio_231" or "phoenixMaster"
 - <equipment's_name>@<SIP_realm>, for example: "phxalio_231@sip.aeq.es" or "phoenixMaster@sip.aeq.es"
 - <equipment's_name>@<SIP_server_IP>, for example: "phxalio_231@232.168.1.2" or "phoenixMaster@232.168.1.2" (where 232.168.1.2. is AEQ SIP Server ("sip.aeq.es") IP address)
 - <equipment's_name>@<SIP_server>:<Port>, when SIP port is not 5060 (the one used by default in SIP SERVER mode). For example: "phxalio_231@sip.aeq.es:5061"

VERY IMPORTANT: <equipment's_name> must not be longer than 19 characters.

- Press the green **"Call"** button on the screen, to make the call.
- Answer the call on the other unit, if "Autoanswer" option is not active.
- You can observe the changes of status from OK to CONNECTED and synchronized:

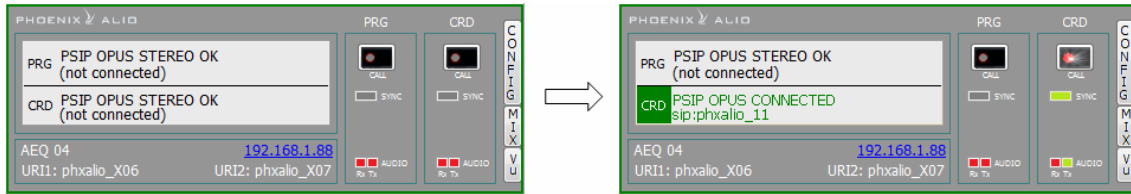

- Verify that the "SYNC" LED beneath the "CALL" button corresponding to that channel is lighted in green to indicate that the communication has been successfully established.
- Send audio from one equipment to another verifying that the "Tx" and "Rx" audio presence indicators change to green.
- If the unit is registering in SIP server and the call is being made but no audio comes through, please check "NAT TRAVERSAL" configuration (see section 4.3).

6.5.2.1. Ending an IP call in PROXY SIP mode.

- In order to hang call, just click on "CALL" button corresponding to that channel in one of both codecs' individual control window. A confirmation message will appear and the call will be disconnected after acceptance.

6.5.2.2. Receiving and accepting an IP call in PROXY SIP mode.

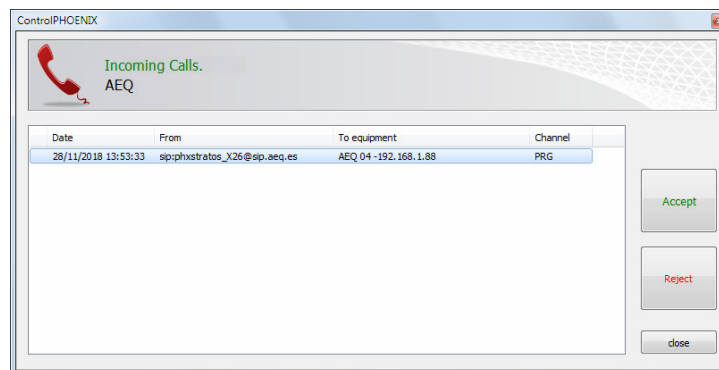

If the IP interface is correctly configured and automatic answer mode is OFF, when you receive a call:

- The unit and the application will provide acoustic warning. This can be disabled (for the unit) at "Configuration" → "Miscellaneous" → "Buzzer and test".
- The "CALL" button red LED corresponding to that channel at the individual codec control window in the remote control software corresponding to the unit that is receiving a call will blink at the same time to warn the user.
- In addition, if "Autoanswer" option is not active, an incoming call window will appear showing the URI identifier of the caller unit:



- The call will be accepted by clicking on the individual codec control window "CALL" button corresponding to that channel or alternatively on the "Accept" button in the incoming calls window.
- The screen will show the status of the call:
 - **CONNECTING**
 - **SYNCHRONIZING**
 - **CONNECTED [-NO_SYNC / -NO_DATA]**
- Verify that the "SYNC" LED beneath the "CALL" button corresponding to that channel is lighted in green to indicate that the communication has been successfully established.
- Once connected to the remote end, verify that the "Tx" and "Rx" audio presence indicators change to green.

6.5.3. Establishing an IP call in DIRECT SIP mode.

- Ensure that the equipment is powered up and controlled by the software.
- Establish the appropriate audio configuration (mixer)
- Check that there is incoming audio to the channel (PROG or COORD) we are going to use to establish the communication: the "Tx" indicator in the individual codec control window , in the general configuration screen  and in the list view  will change to green .

- Go to general configuration screen and configure "INTERFACE" as "DIRECT SIP".

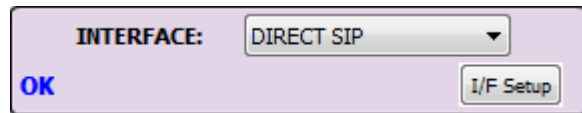

- Enter "I/F Setup" and click on "SIP Parameters". Check that "User Name", "Display name" and "SIP Port" are configured. User name and IP address constitute the equipment's required connection information.

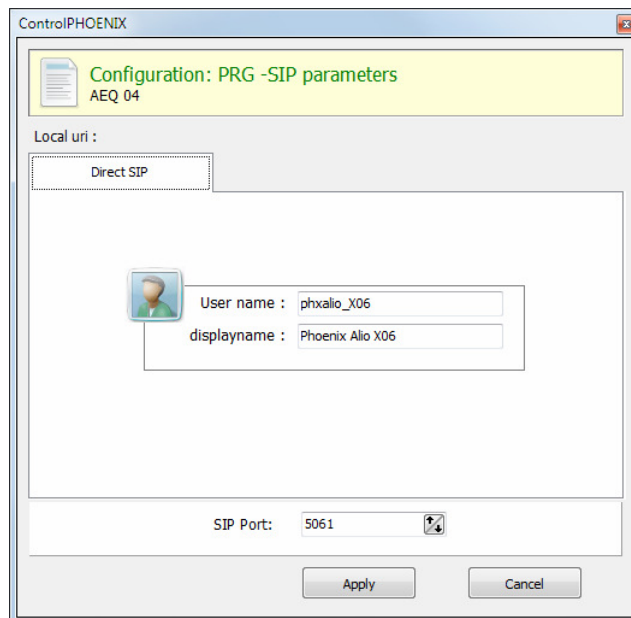

- Select the working mode to traverse NAT devices ("**NAT Traversal**") that is more adequate for the network the unit is connected to.
NOTE: It is recommended that you follow Application Notes 0-A or 0-C, according to the type of equipment's connection.
- At "I/F Setup" fill in the "Local media port" (where the unit expects to receive RTP audio traffic at). If you enable Symmetric RTP mode, the unit will send audio to the same port where it is receiving it from. This is sometimes useful to overcome NAT routers.

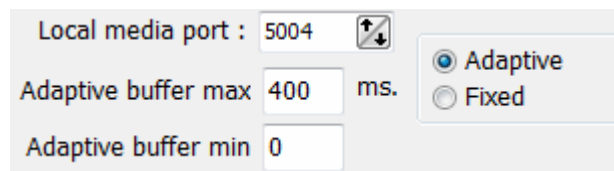

The same screen allows you to configure the type and size of the receiving buffer and FEC parameters as a function of the IP network quality so we have the shortest delay while audio cuts are minimized or eliminated in poor quality networks (see paragraph 4.4 of this manual in order to select the optimal buffer configuration depending on your application).

- Return to the general configuration screen, check that the selected encoding profile in the green "ENCODER" area corresponding to that channel (PRG or COORD) is correct, or otherwise click on "Select codec" to change it. There are several pre-defined profiles containing several particular algorithms each one, with preference ordering. They can be edited and more profiles can be added. The called unit will accept the call using the first coding algorithm that it supports from the list (independently of the profile selected in that unit at that time).



- Decide whether you will use the advanced automatic connection options or not:

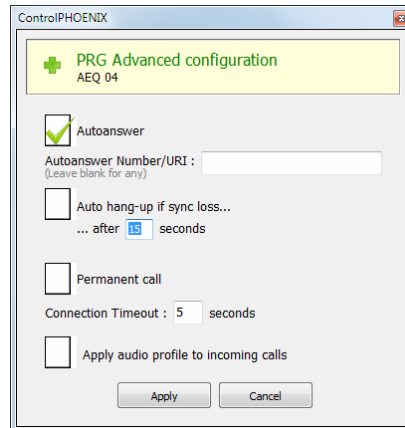

- "Autoanswer": Automatic call answering for all incoming calls, or only those corresponding to a predefined caller.
- "Auto hang-up": Automatic hang-up whenever audio packets are missed for a given time.
- "Permanent call": The device will do what's necessary to keep the call up, even after a line drop or mains cut.
- "Apply audio profile to incoming calls": allows you to filter the SIP calls depending on the encoding profile of the receiver.

- Return to the individual codec control window and click on "CALL" button corresponding to that channel, showing then the call screen:

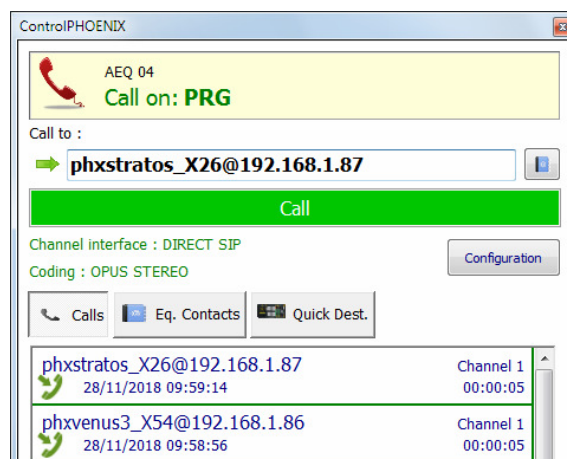

Enter the URI of the remote unit, either manually or getting it from the buttons:

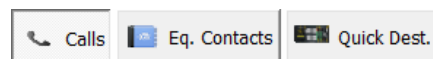

By clicking here, the last completed calls ("Calls") the contacts stored in the call book ("Eq. Contacts") or the reachable IP units ("Quick Dest.") are shown respectively, but only those configured with formats compatible with channel and communication type.

- It is mandatory that the called unit URI is specified in any of the following formats, adequate for Direct SIP communications:
 "<equipment's_name>@<equipment's_IP_address>" (for example: phxalio_11@192.168.1.89).
 If the **SIP port** of the other end is not 5060 (standard SIP port), the identifier must include the port in use:
 For example: "phxalio_11@192.168.1.89:5061".
VERY IMPORTANT: <equipment's_name> must not be longer than 19 characters
- Press the green **"Call"** button on the screen, to make the call.
- Answer the call on the other unit, if "Autoanswer" option is not active.
- You can observe the changes of status from OK to CONNECTED and synchronized when calling from PROGRAM:

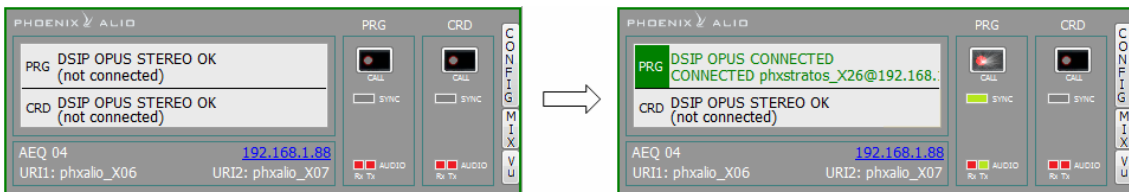

- Verify that the **"SYNC"** LED beneath the **"CALL"** button is lighted in green to indicate that the communication has been successfully established.
- Send audio from one equipment to another verifying that the **"Tx"** and **"Rx"** audio presence indicators change to green.

6.5.3.1. Ending an IP call in DIRECT SIP mode.

- In order to hang call, just click on **"CALL"** button of the connected channel in one of both codecs. A confirmation message will appear and the call will be disconnected after acceptance.

6.5.3.2. Receiving and accepting an IP call in DIRECT SIP mode.

If the IP interface is correctly configured and automatic answer mode is OFF, when you receive a call:

- The unit and the application will provide acoustic warning. This can be disabled (for the unit) at **"Configuration" → "Miscellaneous" → "Buzzer and test"**.
- The **"CALL"** button red LED of the called channel at the individual codec control window in the remote control software corresponding to the unit that is receiving a call will blink at the same time to warn the user.
- In addition, if "Autoanswer" option is not active, an incoming call window will appear showing the URI identifier of the caller unit:

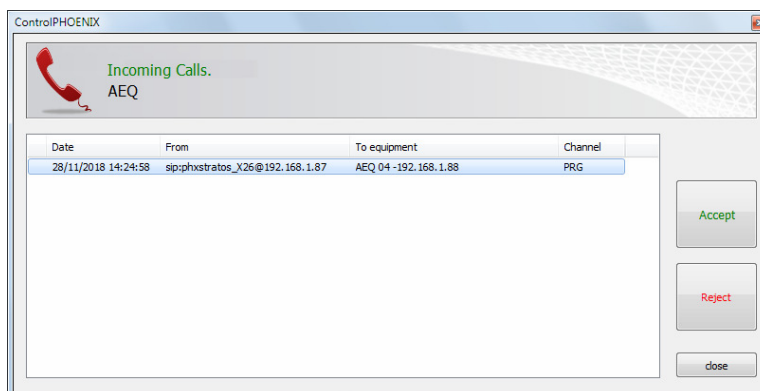

- The call will be accepted by clicking on the individual codec control window "**CALL**" button of the called channel or, alternatively, on the "**Accept**" button in the incoming calls window.
- The screen will show the status of the call:
 - **CONNECTING**
 - **SYNCHRONIZING**
 - **CONNECTED [-NO_SYNC / -NO_DATA]**
- Verify that the "**SYNC**" LED beneath the "**CALL**" button corresponding to that channel is lighted in green to indicate that the communication has been successfully established.
- Send audio from one equipment to another verifying that the "Tx" and "Rx" audio presence indicators change to green.

7. CONTROL TERMINAL OVER WEB BROWSER.

PHOENIX ALIO audiocodec includes a WebServer that enables you to execute numerous functions remotely over the Ethernet interface included in the back panel of the unit by means of a standard web browser (compatibility is guaranteed with Internet Explorer running on Microsoft Windows operating system).

7.1. Upgrading system firmware.

PHOENIX ALIO is supplied from factory with the latest firmware versions available. However, firmware versions with new features may be released in the future, making it necessary to upgrade the equipment to be able to make use of these new functionalities.

Because the upgrading process must be handled with caution, we recommend having it done by an authorized distributor, or under the instructions of the AEQ Technical Service. If you have any doubt, please consult AEQ Technical Service (support@aeq.es).

The firmware upgrade can also be accomplished from the **AEQ ControlPHOENIX** application (see section 6.4.10.1 of "AEQ ControlPHOENIX" application manual).

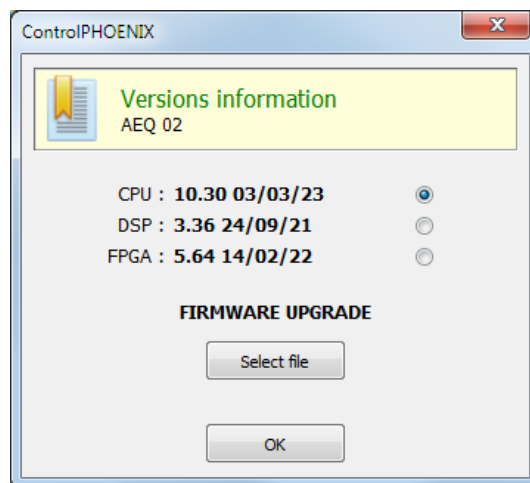

IMPORTANT NOTE 1: If the **CPU** of the equipment is upgraded, configuration of the unit, and in particular IP configuration won't be modified unless expressly stated by AEQ SAT. In that case, the user should take note of all important codec parameters before upgrading in order to reconfigure them afterwards.

The entire PHOENIX ALIO firmware versions upgrading process is done through the IP interface of the unit, with the aid of a standard web browser (compatibility is guaranteed with Internet Explorer running on Microsoft Windows operating system). By default, user and password is "aeq".

IMPORTANT NOTE 2: The **recommended order for upgrading** is: MICRO (CPU), DSP and FPGA. The process is iterative.

IMPORTANT NOTE 3: There are two different models of the **FPGA** module chip (**LX9** and **LX16**). Each model has associated an **exclusive** firmware version. If you have any doubt, please consult AEQ Technical Service.

To upgrade the firmware, you must follow the steps detailed below:

1. From **MENU** → **ETHERNET**, check the IP address associated with the Ethernet interface.
2. Power down the PHOENIX ALIO.

3. Connect PHOENIX ALIO to the PC from which you are going to perform the upgrading process using a crossed cable.
4. Power up the PHOENIX ALIO.
5. Open the Internet Explorer web browser and, in the address bar, enter HTTP://<IP address obtained in point 1>. Press ENTER and the main screen will be displayed.

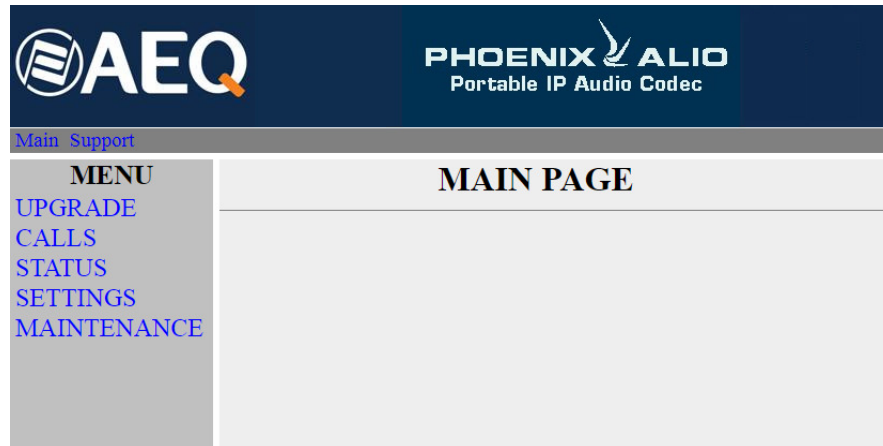

Main screen detail

6. To upgrade the codec, click on the **UPGRADE** option.
7. A user ID and password are requested (by default, both are **aeq**). After you have correctly entered these two items, the firmware upgrading screen will be displayed.

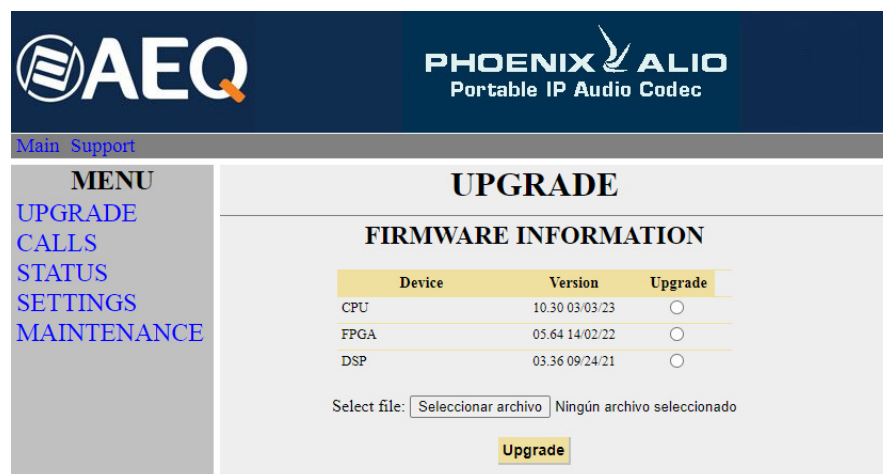

Firmware upgrading screen detail

8. Check to see whether the versions displayed are the same as the firmware that is currently in effect. If they do not match, upgrade the firmware as indicated below.
9. Select the module you want to upgrade in "Upgrade" column. **NOTE:** Each upgrading file is specifically designed to upgrade a specific module within the unit: CPU, DSP or FPGA.
10. In "**Select file**" enter the access route to the upgrade file containing the new firmware version, using the "**Seleccionar archivo**" button.
11. Press the "**Upgrade**" button in the lower part of the screen.
12. Wait for on-screen confirmation that the operation has been successfully completed.
13. In the Internet browser, go to the **UPGRADE** section and ensure that all the firmware versions installed in your codec are now the correct ones.
14. Power the unit down.

7.2. Configuring the IP parameters and the MAC address associated with the Ethernet interface.

From this menu the IP parameters and the MAC address associated with the Ethernet interface can be edited. Because of the consequences the MAC address configuration could have, this action should only be carried out if the codec use situation requires it; the editing should be performed by highly qualified personnel or under the supervision of AEQ authorized technical services, and always in possession of the required network information.

1. From **MENU** → **ETHERNET**, check the IP address associated with the Ethernet interface.
2. Power down the PHOENIX ALIO.
3. Connect PHOENIX ALIO to the PC from which you are going to perform the upgrading process using a crossed cable.
4. Power up the PHOENIX ALIO.
5. Open the Internet Explorer web browser and, in the address bar, enter HTTP://<IP address obtained in point 1>. Press ENTER and the main screen will be displayed. Selecting the **MAINTENANCE** option will enable you to modify the IP parameters and the MAC address of the Ethernet interface of the unit.

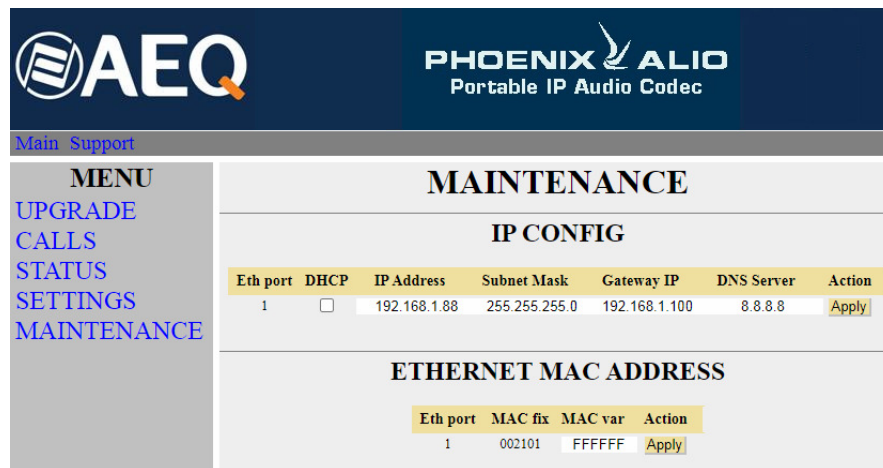

Ethernet interface screen detail

6. Modify the value of the IP parameter or the MAC field associated with the Ethernet interface.
7. Press the "**Apply**" button.
8. In the Internet browser, go to the **MAINTENANCE** section and check that the configuration of IP parameters or MAC address is now correct.
9. Power the unit down.

7.3. Technical Service and on-line manuals.

Clicking on the "**Support**" tab in the upper part of the screen will take you to **AEQ** website, where you will find all the information you need to directly contact the AEQ Technical Service, as well as all the technical information and manuals regarding the unit.

7.4. Saving and loading configurations.

In the **MAINTENANCE** section, in the lower part of the screen, you will see the **CONFIGURATION MEMORY** option, from which you can save the current configuration of the unit (by means of "DOWNLOAD" button) or load a configuration previously created and saved (by selecting the corresponding file and pressing then the "Save configuration" button). The extension of the files used in this process is "AFU". The "Reset configuration" button allows you to restore the default configuration of the unit.

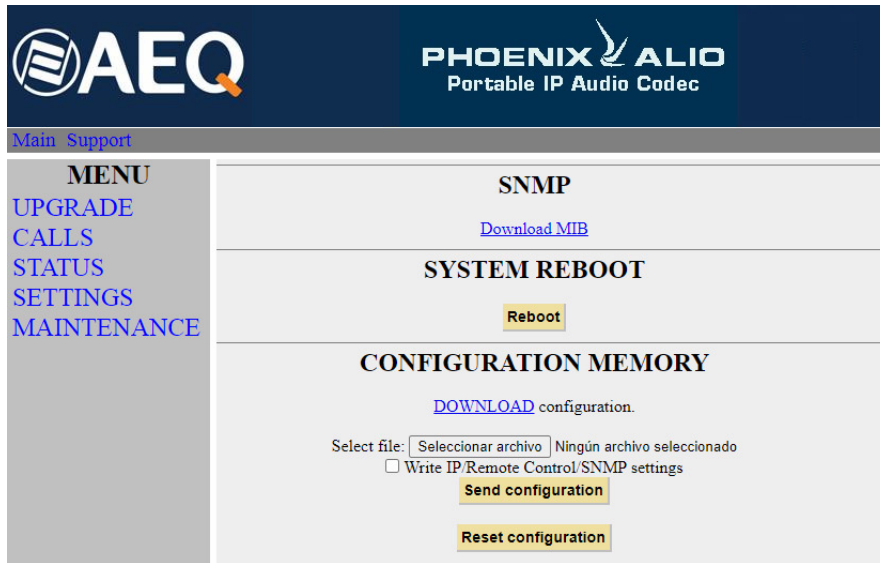

Configurations screen detail

7.5. Screen capture.

The unit allows you to capture the screen displayed in the multifunction screen at any moment in order to save it into a PC in BMP image format. This function may be useful in order to prepare documents or report problems or doubts to SAT.

In order to capture a screen, open the web browser and write the following text in address bar:
http://<unit_IP_address>/GrabScreen

A new screen will appear showing the image. Place the pointer on the image, press the right mouse button and select "Save Image as" (the message may vary depending on the web browser). The saved image has a resolution of 132x68 pixels, 4 bit/pixel.

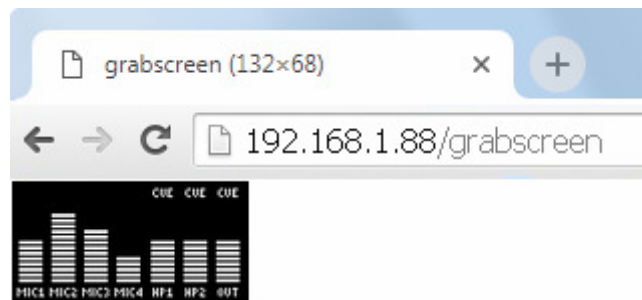

Screen capture detail

7.6. Status menu.

By means of IP Status menu you can monitor some statistical parameters regarding the connection status of IP channels. Some of these parameters are: transmission and reception buffers status, Jitter, lost packets... Channel 0 corresponds to PROGRAM and Channel 1 corresponds to COORDINATION.

This information can also be accessed with a more elaborated presentation from the **AEQ ControlPHOENIX** application (see section 5.5 of "AEQ ControlPHOENIX" application manual).

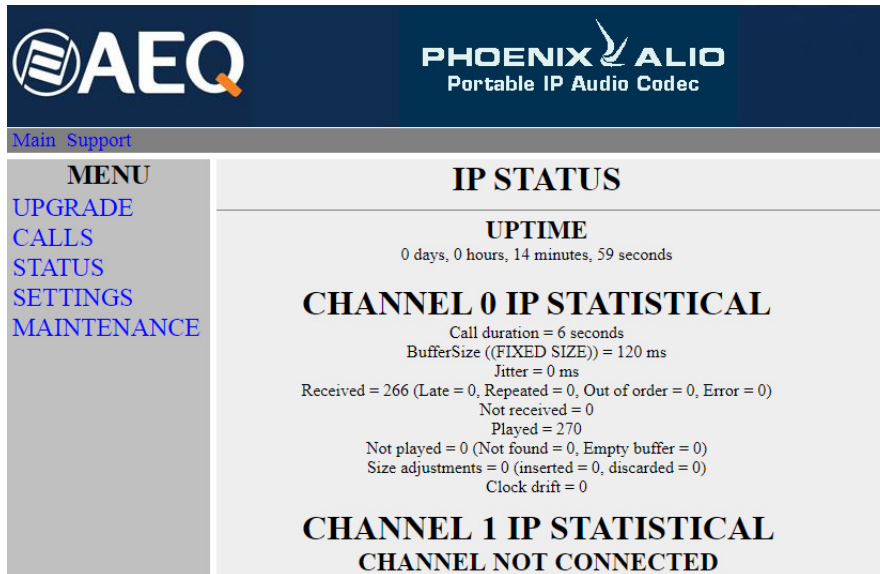

IP Status screen detail

7.7. SNMP.

This unit can be remotely managed using **SNMP** (Simple Network Management Protocol) using one of the many client pieces of software available in the market, even for free. SNMP allows monitoring of the status of several pieces of equipment from very diverse manufacturers and natures, as well as elaborating reports, generate e-mail alerts, etc.

In order to add and equipment to the list of units managed by the client, it is necessary to have access to its "MIB" file (Management Information Base), that describes its SNMP capabilities (alarms it can generate, accepted commands, manufacturer information, etc.).

The MIB file corresponding to the unit can be downloaded from the Web interface without installation of any additional software. In order to do so, in the MAINTENANCE section, you can access the link "**Download MIB**" under the "**SNMP**" section.



SNMP screen detail

If you follow that link, the text file will appear. Now you just need to right-click on it and select "Save as..." and browse a suitable destination folder (see the manual of the selected SNMP client).

For more information, please consult section 4.7 of this manual and section 6.5.1 of "AEQ ControlPHOENIX" application manual.

7.8. Remotely rebooting the equipment.

Sometimes a remote unit can work abnormally or become unreachable by the remote control software as a result of a communications error or in the unit itself. A method has been developed in order to remotely reboot the audiocodec, so normal operation is recovered.

Inside MAINTENANCE, at the bottom of the screen, you can find "**SYSTEM REBOOT**" section. By clicking on "**Reboot**" button, an information dialog will appear warning that the equipment is being rebooted and it will be disconnect for some seconds after acceptance ("Resetting system... please wait a few seconds before connecting again").

8. TECHNICAL SPECIFICATIONS *

Audio input and output	
4 dynamic or condenser MIC inputs	Commutable Phantom 12V 10mA supply. Dynamic range: >90 dB.
Stereo analog line input	2 x female XLR. 9 Kohm input impedance. Electronically balanced. Line level.
Stereo analog line output	2 x male XLR. Output impedance < 100 ohm. Electronically balanced. Line level.
Headphone output	2 ¼" stereo jacks for high or low impedance headphones with volume control
Audio characteristics	
Nominal output level	+0 dBV
Max output level	+20 dB above nominal, THD < 0.5%
Max input level	+20 dBV (+22 dBu)
Output impedance	< 100 ohm
Distortion	< 0.03 % (linear loop) (depends on chose encoding algorithm)
Dynamic range	> 100 dB (linear, no compression)
Crosstalk	< -70 dB
Binary rate	20 to 2304 Kbps
Operating modes	Mono, stereo, Dual, Jstereo, MS stereo
Frequency response	+/-0.5 dB @ 20 Hz-20 KHz
A/D & D/A conversion	
Analog I/O: A/D & D/A converter type	24 bit Sigma-Delta 48 KHz sampling frequency
Communications interfaces	
IP interface	Ethernet RJ45 10/100Mbps port
Satellite links	An external satellite terminal can be connected to the IP interface (see application note AN2)
3G/4G modem	An external 3G/4G USB modem can be connected to the IP interface by means of an homologated portable router (see application note AN5)
Backup, permanent call, etc.	Menu selectable
Coding algorithms	
	OPUS, G.711, G.722, MPEG Layer 2, PCM... (See APPENDIX A)
Control and data interface	
LAN 10 / 100 base T	RJ45 connector
General characteristics	
Power consumption	14W max.
Weight	2 Kgs
Dimensions	W x D x H (mm): 210 x 240 x 60
Display	1 x OLED 128x64 pixels. 16 greyscale levels. 2 x stereo vumeters, 20 multi-colour LEDs

* Characteristics are subject to changes without previous notice.

Safety regulations

CE Marking.

Electromagnetic compatibility according to EU directives EN 50081-1, EN 50052-2.

9. A.E.Q. WARRANTY.

AEQ warrants that this product has been designed and manufactured under a certified Quality Assurance System. AEQ therefore warrants that the necessary test protocols to assure the proper operation and the specified technical characteristics of the product have been followed and accomplished.

This includes that the general protocols for design and production and the particular ones for this product are conveniently documented.

1.- The present guarantee does not exclude or limit in any way any legally recognized right of the client.

2.- The period of guarantee is defined to be twelve natural months starting from the date of purchase of the product by the first client. To be able to apply to the established in this guarantee, it is compulsory condition to inform the authorized distributor or –to its effect- an AEQ Sales office or the Technical Service of AEQ within thirty days of the appearance of the defect and within the period of guarantee, as well as to facilitate a copy of the purchase invoice and serial number of the product.

It will be equally necessary the previous and expressed conformity from the AEQ Technical Service for the shipment to AEQ of products for their repair or substitution in application of the present guarantee.

As a consequence, returns of equipment that does not comply with these conditions will not be accepted.

3.- AEQ will at its own cost repair the faulty product once returned, including the necessary labour to carry out such repair, whenever the failure is caused by defects of the materials, design or workmanship. The repair will be carried out in any of the AEQ authorized Technical Service Centres. This guarantee does not include the freight charges of the product to or from such Authorized Technical Service Centre.

4.- No Extension of the Guarantee Period for repaired product shall be applied. Nor shall a Substituted Products in application of this Guarantee be subject to Guarantee Period Extension.

5.- The present guarantee will not be applicable in the following situations:
Improper use or Contrary use of the product as per the User or Instruction Manual; violent manipulation; exhibition to humidity or extreme thermal or environmental conditions or sudden changes of such conditions; electrical discharges or lightning; oxidation; modifications or not authorized connections; repairs or non-authorized disassembly of the product; spill of liquids or chemical products.

6.- Under no circumstances, whether based upon this Limited Guarantee or otherwise, shall AEQ, S.A. be liable for incidental, special, or consequential damages derived from the use or from the impossibility of using the product.

AEQ shall not be liable for loss of information in the disks or data support that have been altered or found to be inexact, neither for any accidental damage caused by the user or other persons manipulating the product.

APPENDIX A: General characteristics of encoding modes.

OPUS:

OPUS is a completely open and very versatile coding algorithm. Its performance is unrivaled for voice and audio transmission. It was standardized by Internet Engine Engineering Task Force (IETF) as [RFC 6716](#), and combines Skype's SILK codec technology with Xiph.Org's CELT.

This algorithm allows for an excellent audio quality with high compression rate and very low delay. Phoenix family audiocoders feature 7 selected OPUS modes covering nearly every transmission need, from voice to high quality stereo music, with bitrates between 12 and 192 Kbps and audio bandwidth between 6 and 20 KHz. The receiver can automatically adapt to the particular OPUS mode selected in the transmitting end.

G.711:

ITU encoding standard for processing audio signals in the human voice frequency band, through the compression of digital audio samples obtained at 8 KHz, and typically used in telephone systems.

Bandwidth: 3.5 KHz

For further information on this subject, consult:

<http://www.itu.int/rec/T-REC-G.711/e>

G.722:

ITU encoding standard, based on ADPCM algorithms, for processing audio signals in the human voice frequency band, through the compression of digital audio samples obtained at 16 KHz, for greater audio quality and clarity.

This is the internationally accepted mode for two-way communication because of its low delay, which is why it is the most used standard in commentator and sports broadcasting applications.

Bandwidth: 7 KHz.

For further information on this subject, consult:

<http://www.itu.int/rec/T-REC-G.722/e>

MPEG LAYER II:

Well known, widely accepted encoding mode that is used when the delay is not important, since MPEG modes always have a greater delay than G.722 modes. There are 64 Kbps encoding modes with sampling rates of 48, 32 or 24 KHz, and 128 Kbps encoding modes with sampling rates of 32 and 48 KHz.

Bandwidth: 10 KHz to 15 KHz.

For further information on this subject, consult: ISO/IEC 11172-3 and ISO/IEC 13818-3.

AEQ LD+:

AEQ proprietary mode (based on the previous AEQ-LD Extend mode) that combines the low delay offered by G.722 with the greater bandwidth of the MPEG modes, optimizing these two aspects.

PCM (12/16/20/24 bits):

Linear audio without any compression process.

For further information on this subject, consult

<http://www.digitalpreservation.gov/formats/fdd/fdd000016.shtml>

Other different encoding modes can be taken into account according to specific needs of each client.

Available coding algorithms list in Phoenix ALIO. Please contact us to check availability of other algorithms.

CODEC	RATE (Kbps)	Fs (KHz)	Mode	Approx audio BW (KHz)
OPUS	12	48	VOICE RB	6
	20	48	VOICE	8
	32	48	MUSIC MONO RB	20
	64	48	MUSIC MONO	20
	64	48	MUSIC STEREO RB	20
	128	48	MUSIC STEREO	20
	192	48	MUSIC STEREO HQ	20
G.711 A-law	64	8	MONO	4
G.711 μ -law	64	8	MONO	4
G.722	64	16	MONO	7.5
AEQ-LD	64	16	MONO	7.5
	128	32	MONO	15
	192	48	MONO	19
	128	16	STEREO	7.5
	256	32	STEREO	15
	384	48	STEREO	19
MPEG-1 Layer II	64	32 / 48	MONO	10.5
	128	32 / 48	M / ST / JST	10.5/16.5
	192	32 / 48	M / ST / JST / D	10.5/16.5
	256	32 / 48	ST	16.5
	384	48	STEREO	16.5
MPEG-2 Layer II	64	16 / 24	MONO	8/12
	128	24	MONO	12
PCM (12,16,20,24 bit/sample)	384 a 768	32	MONO	16
	768 a 1536	32	STEREO	16
	576 a 1152	48	MONO	20
	1152 a 2304	48	STEREO	20

Other different encoding modes can be taken into account according to specific needs of each client.

APPENDIX B: Protocols associated with IP communications.

Communication over IP networks differs notably from the communications traditionally used to date in broadcast environments, whether they are POTS or ISDN, in that IP networks do not have dedicated resources or qualities of service implemented in most systems, with the associated problems this involves in terms of communication signaling, establishment, maintenance and clear-down.

This set of problems originates in the technical characteristics that are intrinsic to the definition and operation of communications systems based on IP protocols. The EBU-TECH 3326 standard developed by the N/ACIP working group provides certain tools for attempting to simplify work by making use of many protocols associated with IP communication, and which will be described below.

N/ACIP

- Signaling, understood as connection initiating and ending procedures, as well as negotiation of connection parameters (encoding algorithms, ports, etc.)
 - SDP (Session Description Protocol) to describe the parameters of the connection
 - SAP (Session Announcement Protocol) for multicast type unidirectional links
 - SIP (Session Initiation Protocol) simulates the working system in traditional telephone networks
- Transport: defines the transport protocols over IP networks
 - RTP (Real-Time Transport Protocol) over UDP and IPv4
 - RTCP (Real-Time Control Transport Protocol) for synchronization and active retrieval functions
 - IP ports defined: 5004 / 5008 (RTP for PROG / COORD, respectively) and 5005 / 5009 (RTCP)

While this appendix is not intended to be a reference document for all the relevant technical matters, it should at least serve to give its readers an initial contact with these subjects that will ease the assimilation of the new working method over IP networks for the Phoenix ALIO user and, as a result, the use of this equipment. The user interested in expanding his or her knowledge of some or all of these subjects is encouraged to turn to the extensive, excellent technical material currently available regarding the IP realm and the technologies associated with it.

B1. Circuit switching versus packet switching.

The communications systems traditionally used in the broadcast environment for applications with portable codecs have been mostly telephone or ISDN networks—that is, circuit switching networks; Phoenix ALIO, on the other hand, uses a packet switching network in its IP interface.

B1.1. Circuit switching.

In a circuit switching network, the switching equipment must establish a physical path between the communication media prior to the connection between users. This path remains active during the communication between the users, and is cleared down or released when the communication ends. Example: Switched telephone network.

Its operation passes through the following stages: request, establishment, file transfer and connection clear-down.

B1.1.1. Advantages:

- The transmission is made in real time.
- Dedicated resources. The nodes that are involved in the communication use the established circuit exclusively as long as the session lasts.

- Once the circuit has been established, the parties can communicate with each other at the highest speed that the medium allows, without having to share the bandwidth nor the use time.
- The circuit is fixed. Because a physical circuit is specifically dedicated to the communication session in question, once the circuit is established there are no losses of time for calculation and decision-making regarding routing through the intermediate nodes. Each intermediate node has a single route for the incoming and outgoing packets that belong to a specific session, which means it is impossible for the packets to be disordered.
- Simplicity in the management of intermediate nodes. Once the physical circuit has been established, no further decisions need to be made to route the data from origin to destination.

B1.1.2. Disadvantages:

- Delay in initiating communication. A time interval is required to make the connection, which entails a delay in the transmission of the information.
- Blockage of resources. No use is made of the circuit during the moments when there is no transmission between the parties. Bandwidth is wasted while the parties are not communicating with each other.
- The circuit is fixed. The communication route is not readjusted; it is not adapted at each opportunity to the least costly path between the nodes. Once the circuit has been established, no use is made of the alternative, less expensive pathways that may become available during the session.
- Poor fault tolerance. If an intermediate node fails, the entire circuit crashes. The connections then have to be re-established from zero.

B1.2. Packet switching.

The sender divides the message to be sent into an arbitrary number of packets of the same size, to which a header and the originating and destination addresses are added, as well as control data that will then be transmitted through different communication media between temporary nodes until they reach their destination. This switching method is the one that is used in today's IP networks. It has emerged to optimize transmission capacity through existing lines.

The temporary nodes store the packets in queues in their memories, which need not be very large.

B1.2.1. Switching modes.

- Virtual circuit: Each packet is routed through the same virtual circuit as the preceding ones. Therefore the order of arrival of the packets to their destination is controlled and ensured.
- Datagram: Each packet is routed independently from the rest. Thus the network cannot control the path followed by the packets, nor ensure the order in which they reach their destination.

B1.2.2. Advantages:

- In case of error in a packet, only that packet will be resent, without affecting other packets that arrived without errors.
- Interactive communication. Limiting the maximum packet size ensures that no user can monopolize a transmission line for very long (microseconds), which means that packet switching networks can handle interactive traffic.
- Packet switching increases network flexibility and profitability.
- The pathway a communication takes can be altered from one moment to the next (for example, in case one or more of the routers breaks down).

- Theoretically, priorities can be assigned to the packets in a given communication. Thus, a node can select, from its queue of packets waiting to be transmitted, the ones that have higher priority.

B1.2.3. Disadvantages:

- Greater complexity of the intermediate switching devices, which need to have higher speed and greater calculating capacity to determine the appropriate route for each packet.
- Packet duplication. If a packet takes too long to reach its destination, the receiving device may conclude that it has been lost, in which case it will send a packet retransmission request to the sender, which gives rise to the arrival of duplicate packets.
- If the routing calculations account for an appreciable percentage of the transmission time, the channel throughput (useful information / transmitted information) decreases.
- Variations in the mean transit delay of a packet in the network. Parameter known as jitter.

B2. IP protocol.

The Internet Protocol (IP) is a non-connection oriented protocol used both by the origin and the destination in data transmission over a switched packet network.

The data in an IP-based network are sent in blocks known as packets or datagrams (in the IP protocol these terms are used interchangeably). In particular, in IP there is no need for configuration before a device attempts to send packets to another with which it has not communicated previously.

The Internet Protocol provides an unreliable datagram service called UDP (User Datagram Protocol), also known as "best effort", a phrase that expresses good intentions but offers few guarantees. IP does not offer any mechanism to determine whether a packet reaches its destination, and only provides security (by means of checksums) to cover its headers, and not the transmitted data. For example, since it gives no guarantee that the packet will reach its destination, it could arrive damaged, in the wrong order with respect to other packets, duplicated, or simply not arrive. If reliability is needed, it is provided by transport layer protocols such as TCP (Transport Control Protocol).

Reliability over TCP is obtained through the use of retransmissions. Real-time applications such as an audio link, with the timing requirements inherent in the information contained in the link, do not offer any useful guarantee. Since the data that are not received, and whose retransmission is requested of the sender by the receiver, will in most cases arrive out of order, they will end up as useless information that will have served only to overload the network. For all these reasons, the protocol selected to serve as a communication substrate in real-time applications is UDP.

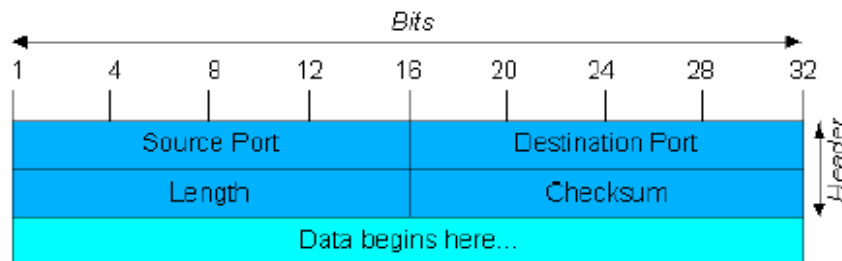

UDP Datagram

Transport over IP protocols, independently of the reliability they offer, add new functionalities to the basic ones provided by IP, such as packet numbering to facilitate, on the receiving end, the detection of losses (although not their correction) and of disorder in the information received; and the advent of the port concept as an identifier of different logic connections over the same IP interface.

For complete information on IP protocol, we recommend consulting:

<http://tools.ietf.org/html/rfc791>

<http://www.iana.org/assignments/port-numbers>

B2.1. IP addressing.

An **IP address** is a number that logically and hierarchically identifies an interface of a device in a network that uses the IP protocol. The format used is X.X.X.X, where each X represents a group of eight bits translated into decimal form—that is, whose minimum value is 0.0.0.0 and whose maximum value is 255.255.255.255.

IP addresses are classified in two major groups: static and dynamic.

- It is typical for a user to connect to the Internet from his or her home using an IP address. This address may change when the user reconnects, and this manner of assigning IP addresses is called a *dynamic IP address* (normally abbreviated as *dynamic IP*).
- The Internet sites that, by nature, need to be continuously connected generally have a *static IP address* (as with the dynamic address, a similar abbreviated form is used: *static* or *fixed IP*)—that is, an address that does not change over time.

Another possible IP address classification can be made according to address validity:

- **Public:** IP addresses that are valid in the entire Internet network. Currently, due to the poor management that has traditionally been applied to the available IP addresses, they are a scarce, highly costly resource.
- **Private:** addresses that are only valid in a closed section of the IP network, typically corporate and not subject to free access, with only one point of connection to the Internet, called a gateway, constituted by a router.

B2.2. Unicast vs. Multicast.

Unicast is the transmission of information from a single sender to a single receiver. It is distinguished from multicast (transmission to certain specific recipients—more than one—from a single sender), broadcast (in which the recipients are all the stations in the network) and anycast (transmission to a single recipient—any unspecified recipient).

The unicast method is the one currently being used on the Internet, and is applied for both live and on-demand transmissions. The multicast method can only be used in corporate environments, despite some isolated efforts to introduce it on the Internet, and is applied only for live transmissions.

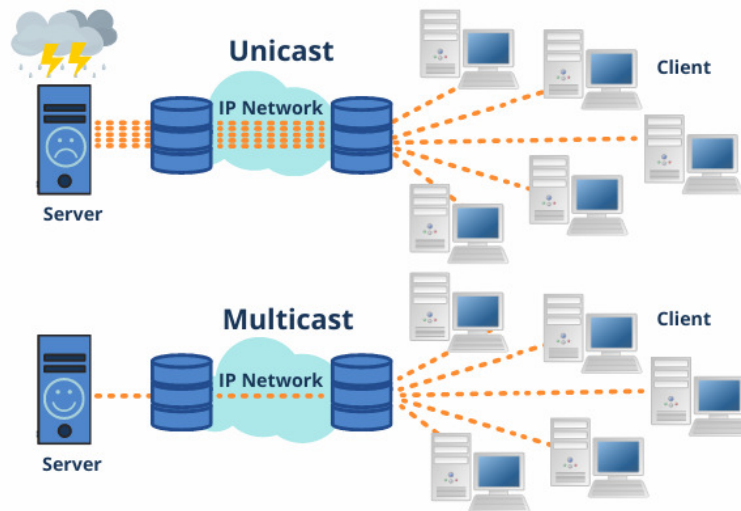

Graphical comparison: Unicast vs. Multicast

The effect that unicast transmission has on network resources is accumulative consumption. Each user who connects to a multimedia transmission consumes as many kilobits per second as the content encoding will permit.

B3. RTP protocol.

RTP are the initials of **Real-time Transport Protocol**. It is a transport level protocol used for the transmission of information in real time, as occurs with audio and video. Normally it is paired with RTCP (RTP Control Protocol) and is located on UDP.

The IP ports defined for its use are 5004 (RTP) and 5005 (RTCP) for PROG and 5008/5009 for COORD.

The functions of the RTP/RTCP protocol are:

- Management of the reception buffer in order to minimize the jitter effect introduced by the network.
- Recovery of the reference clock based on information inserted by the transmitting equipment.
- Test tools to permit the user to verify the bandwidth, the delay and estimated jitter in the connection.

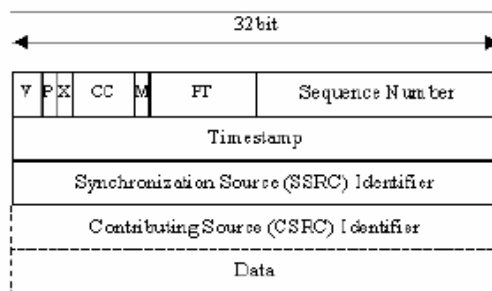

RTP Header

For complete information on RTP/RTCP protocol, we recommend consulting:

- <http://tools.ietf.org/html/rfc1889>
- <http://tools.ietf.org/html/rfc1890>
- <http://tools.ietf.org/html/rfc3550>
- <http://tools.ietf.org/html/rfc3551>
- <http://tools.ietf.org/html/rfc3711>

B3.1. Default PHOENIX ALIO configuration.

PHOENIX ALIO is an IP audiocodec that operates by using RTP over UDP in IP version 4.

By default, PHOENIX ALIO is supplied from the factory with the following IP ports defined: 5004 for RTP and the next one (5005 in this case) for RTCP, for the PROGRAM channel, and 5008 + 5009 for the COORDINATION channel (if licensed).

The RTP port values can be modified from its internal menu, and RTCP ports will be automatically assigned accordingly.

B4. SIP protocol.

Session Initiation Protocol (SIP) is a protocol developed by the IETF MMUSIC Working Group with the intention of establishing the standard for initiating, modifying and ending interactive user sessions involving multimedia elements such as video, voice and instant messaging.

SIP is used simply to initiate and terminate voice and video calls. Once the communication is established, the exchange of voice / video information is conducted only over RTP.

One of the objectives of SIP was to contribute a set of processing functions to apply to calls and capacities present in the public switched telephone network. Thus, it implemented typical functions that a common telephone terminal offers, such as: calling a number, making a telephone ring when called, hearing a dial tone or busy tone. The implementation and terminology in SIP are different.

SIP requires proxy servers and register elements to give a practical service. Although two SIP terminals can communicate with each other without the mediation of SIP infrastructures through the use of URIs of the name@IP-address type (which is why SIP is defined as a point-to-point protocol), this approach is impracticable for a public service because of the problems inherent in IP addressing, where obtaining static public addresses is nearly impossible and extremely costly.

To simplify the operation of the unit, AEQ offers, at no additional cost, the services of its 2 own SIP servers (one of them working as main server and the other one as backup server), although it cannot guarantee its operation 100% of the time, nor be held responsible for the inconveniences that this may produce for the end user. The unit leaves the factory preconfigured with the parameters required to work with the resources of any of these 2 SIP servers.

SIP makes use of elements called **proxy servers** to help route the requests toward the user's current location, authenticate users to give them service, enable call routing policies to be implemented, and contribute added capabilities to the user.

SIP also contributes register functions that enable the user to inform the proxy servers of his or her location.

For complete information on the SIP protocol, we recommend consulting:
<http://tools.ietf.org/html/rfc3261>

B4.1. Working modes.

With the PROXY SIP option activated in the Phoenix ALIO, when the unit is started up it will automatically connect and register itself in the SIP Proxy server configured in its memory, indicating its name (URI: name@domain) and position (IP address).

To establish any communication, the unit that wishes to establish the connection will search the SIP Proxy server register for the information regarding the called device and will redirect the call—in a way that is transparent to the user—toward the real physical place where the device is located.

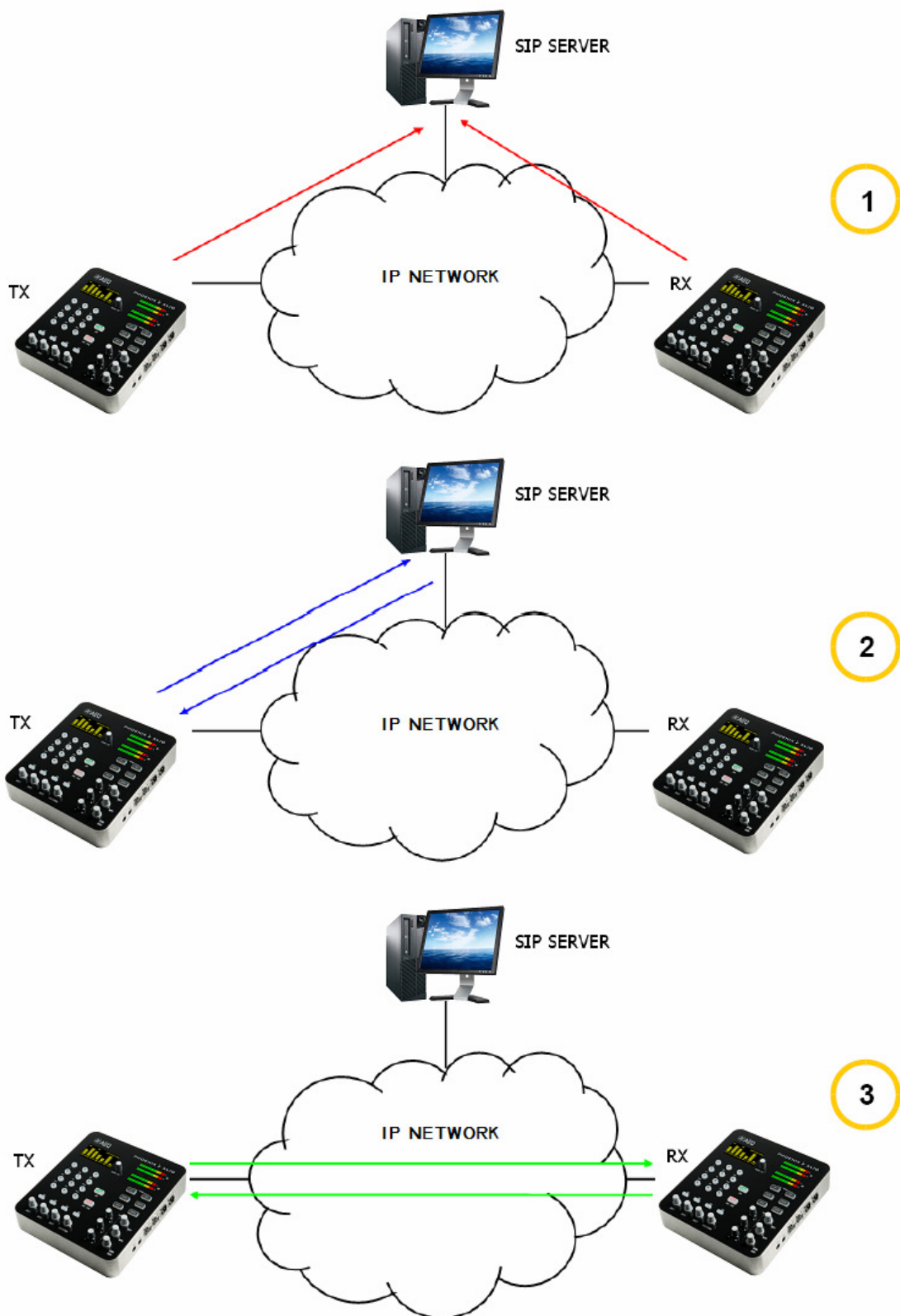

SIP protocol operation diagram. Phase 1: Registration. Phase 2: Search for the called device in the SIP server database. Phase 3: Establishment of the connection

This working method, supported by external SIP servers, enables the physical position of a device to be made independent from its logic identifier and, through the use of the SIP protocol, makes it unnecessary to know more data regarding the called device than its URI.

During the establishment of the communication phase, the encoding algorithm is negotiated simultaneously, based on the Link Profiles / SIP Codec Profiles defined in each of the devices at the two ends of the connection circuit.

B4.2. Possible work scenarios.

Depending on the type of network to which the PHOENIX ALIO is connected, the codec will have one or another type of IP address available to it.

- Static public IP addresses offer the ideal situation, since they guarantee that the IP interface of the codec will always be assigned to a fixed address (regardless of whether it is turned off and then powered up again) and directly accessible to the rest of the network users. Phoenix ALIO operates perfectly with an associated SIP server and equipment identifiers of the name@domain type (PROXY SIP), and even without an associated SIP server with a URI of the name@IP-address type (DIRECT SIP) if the device on the opposite end of the communication circuit also has an IP address of the same type.

This situation corresponds to use an Internet access by means of a single workstation router (just one piece of equipment connected) and to hire a fixed IP.

- Dynamic public IP addresses, corresponding to use an Internet access by means of a single workstation router and a dynamic IP (the most usual). Allows the use of URIs of the name@domain (PROXY SIP) or name@IP-address (DIRECT SIP) type, but it is advisable always to work with an associated SIP server (PROXY SIP), since the IP address assigned to the equipment may change each time the user powers up the unit.
- Private IP addresses, both static and dynamic, corresponding to connections in a local network with several workstations, that access to the Internet through a router with NAT. Those do not allow the use of URIs of the name@IP-address type because the IP address of the identifier is not public, and is only valid in the section of the network to which it has been assigned; it lacks a universal meaning. In this case the use of an associated SIP server and a STUN server is imperative to get past the NAT (Network Address Translation) implemented in the router that acts as an interface between the private network and the public one. See section NAT TRAVERSAL (4.3).

B4.3. PHOENIX ALIO default SIP configuration.

To simplify operating the unit, AEQ offers, at no additional cost, the services of 2 own SIP servers.

PHOENIX ALIO is supplied from the factory with both SIP servers preconfigured (SYSTEM → SIP PROVIDERS menu) defined as "AEQ" and "AEQ 2" with the following configuration:

- PROXY SIP "AEQ" Host: sip.aeq.es
- PROXY SIP "AEQ 2" Host: sip2.aeq.es
- PROXY SIP "AEQ" and "AEQ 2" Port: 5060
- PROXY SIP "AEQ" and "AEQ 2" Domain: sip.aeq.es
- PROXY SIP "AEQ" and "AEQ 2" Register Expires: 60 min.

PHOENIX ALIO is supplied preconfigured with **2 users** registered in both servers:

- PROXY SIP "AEQ" and "AEQ 2" Authentication Users: phxalio_XXX y phxalio_XXY (where Y=X+1)
- PROXY SIP "AEQ" and "AEQ 2" Authentication Passwords: 8 digits alphanumeric passwords

This configuration is the right one for working with any of both AEQ's SIP servers.

B5. STUN protocol.

STUN (Simple Transversal of UDP over NATs) is a network protocol of the client /server type that allows NAT clients to find their public IP address, the type of NAT where it is located and the Internet port associated with the local port through NAT. This information is used to configure a UDP communication between two hosts located behind NAT routers.

NAT (Network Address Translation) is a mechanism used by IP routers to exchange packets between two networks that assign each other incompatible addresses. It consists of converting, in real time, the addresses used in the transported packets. It is also necessary to edit the packets to enable the operation of protocols that include address information within the protocol conversation. It is most commonly utilized to enable the use of private addresses and still provide connectivity with the rest of the Internet.

PHOENIX ALIO includes a STUN client that sends a request to a STUN server. The STUN server then informs the client of its public IP and which port has been opened by NAT to permit incoming traffic to enter the client's network. This information enables the Phoenix ALIO to identify its position within the SIP server. This protocol is used in "AUTO3" and "AUTO4" NAT TRAVERSAL modes (see section 4.3).

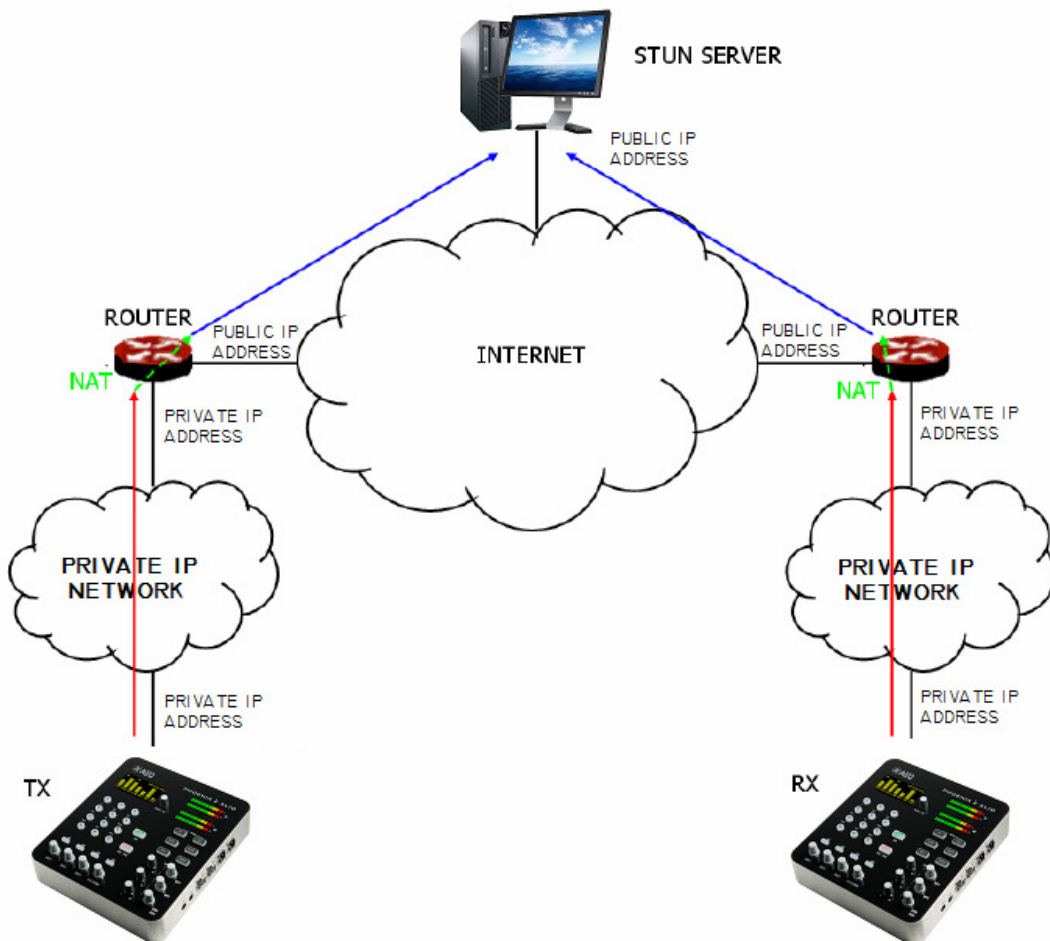

Registration in a STUN server

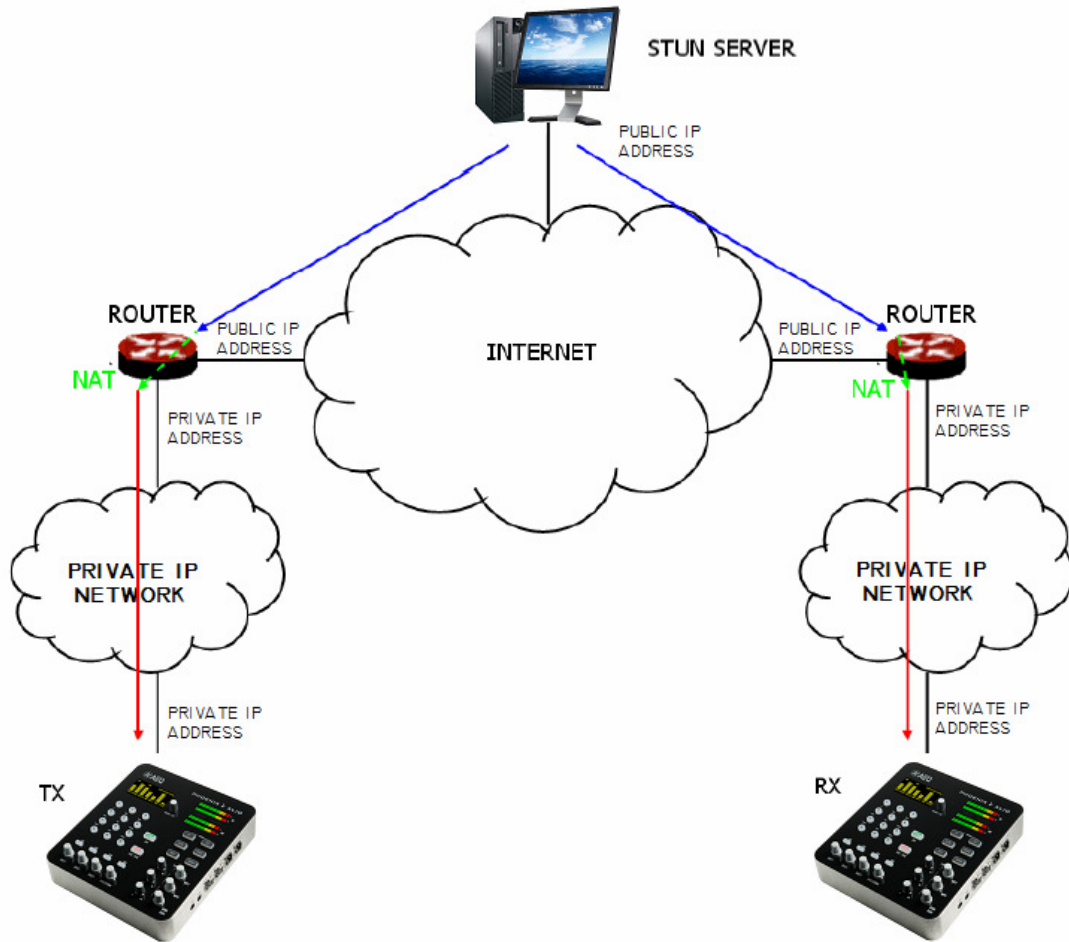

Notification from the server of the corresponding NATs detected

The response further enables the STUN client to determine the type of NAT being used, since different NAT types handle incoming UDP packets in different ways. STUN supports three of the four main existing types of NAT: *Full Cone*, *Restricted Cone* and *Port Restricted Cone*. It does not, however, support *Symmetric NAT*, also known as bidirectional NAT, although Phoenix ALIO allows it to be detected and reports its presence to the user.

Once the client has discovered its public address, it can advise its peers of that address.

STUN is useful as a complement to protocols like SIP. SIP uses UDP packets to signal sound, video and text traffic over the Internet, but does not enable communication to be established when the devices at the ends of the communication circuit are behind NAT routings. This is why STUN is customarily used in these applications, to permit communication to be established.

The connection with the STUN server is normally made through port 3478 by means of UDP. The STUN server can then provide the client with an alternate IP and communication port.

For complete information on the STUN protocol, we recommend consulting:
<http://tools.ietf.org/html/rfc3489>

AEQ always has a PHOENIX unit available for test at "phoenixMaster@sip.aeq.es" URI and its 2 SIP servers are also available at sip.aeq.es and sip2.aeq.es and with warranty that both work according to the official standard.

APPENDIX C: Ports used by PHOENIX equipment.

When Phoenix unit is installed in a private IP network and you want to establish communication with other units through that network router+firewall (gateway), three indications related to the ports used by the unit must be taken into account:

1 - Output permissions in router+firewall.

Phoenix unit will send packets to different servers and/or other units (each one will use a different port). Therefore, firewall will have to allow that packets from Phoenix unit IP are sent towards the following ports:

Protocol	Port number	Usage
UDP	53	DNS (domain name server) protocol
UDP	162	SNMP Traps port
UDP	5004-5010 (may change)	RTP protocol (audio packets going towards the remote unit, ports depend on the remote unit network, not Phoenix one)
UDP	3478-3479	STUN protocol (server for getting the public IP of the private network)
UDP	5060-5062	SIP protocol (SIP signalling packets, port depends on the remote unit network, not Phoenix network)
UDP	50000-60000	Vumeters protocol (only when remote control PC is not in Phoenix network)
TCP	4422	Remote control protocol (only when Phoenix must be connected to PC and PC is not in its network. Port depends on PC, not on Phoenix)

2 - Input permissions in router+firewall.

Phoenix unit will have to be able to receive packets from units installed out of the private network. Therefore, firewall will have to allow that packets sent to Phoenix unit IP to the following ports are received:

Protocol	Port number	Usage
UDP	161	SNMP protocol (monitoring)
UDP	5004-5010 (may change)	RTP protocol (audio packets towards the remote unit, ports depend on Phoenix configuration)
UDP	5060-5062	SIP protocol (SIP signaling packets, port depends on the remote unit network, not Phoenix network)
TCP	80	HTTP protocol (only when PC must be connected to Phoenix web server for a firmware upgrading, for instance)
TCP	4422	Remote control protocol (only when PC must be connected to Phoenix and PC is not in its network)

3 - When router+firewall uses NAT translation between private and public addresses, then a Port Forwarding must be made in the router for each one of the ports described in section 2 and for each one of the IPs of Phoenix units installed in that private network. In that case, remote unit will send its packets towards router IP (it's a public IP) and the ports configured in router by means of Port Forwarding (these are public ports), not to each Phoenix ports (these are private ports).

APPENDIX D: Application notes guide.

This index tries to give users guidance on selecting the most advisable application note in order to connect two audiocodex of Phoenix family, depending on its requirements and working environment. Each application note describes the way to configure each of the audiocodex. When both ends are different (for instance, at one end there's a Phoenix Mobile and at the other end a Phoenix ALIO), different application notes should be followed in order to configure each one. All notes are available in electronic format on the USB key furnished with the unit and on the AEQ website.

D1. Internet connection using standard cable access.

Application note AN0A. Phoenix Studio, Venus or Mercury audiocodex directly connected to Internet by means of a dedicated cable-Modem with DHCP. SIP call using AEQ SIP Proxy.

Application note AN0B. Same case as AN0A, but adapted to Phoenix Mobile.

Application note AN0C. Phoenix Studio, Venus or Mercury audiocodex connected to a LAN (together with other IP devices), connected to Internet by means of a router with NAT that can be configured (or we have access to the Network Manager). SIP call using AEQ SIP Proxy.

Application note AN0D. Same case as AN0C, but adapted to Phoenix Mobile.

Application note AN0E. Same case as AN0C, but calling in DIRECT SIP with no SIP Proxy involved.

Application note AN0F. Same case as AN0E, but adapted to Phoenix Mobile.

Application note AN0G. IP Audio distribution at large international events using Phoenix Studio audiocodex.

Application note AN0H. AoIP distribution and contribution system with Phoenix Venus audiocodex for radio broadcasting companies.

Application note AN0I. Login in the alternative AEQ server if working with SIP connectivity some trouble situations are faced.

D2. Special applications using different kinds of Internet physical accesses, or point to point connections.

Application note AN1. Connecting a Phoenix (Studio, Venus, Mercury or Mobile) to Internet through a PC via a WiFi network.

Application note AN2. Connecting two Phoenix Mobile units using a BGAN satellite link.

Application note AN3. Connecting two audiocodex (Phoenix Studio - Phoenix Studio & Phoenix Mobile - Phoenix Studio) using a private WiMAX network.

Application note AN4. Connecting two Phoenix Studio units using a dedicated point-to-point IP radio link.

Application note AN4B. Same case as AN4, but also for Venus and Mercury and configuring the units via remote control software.

Application note AN5. Connecting Phoenix IP (or TALENT) audiocodex to 3G/4G networks.

Application note AN6. Connection and remote control of Phoenix Alio (or Talent) audiocodex from the studio and simultaneous usage as a phone set.

Application note AN7. 3G/4G wireless transmission system using AEQ Talent or Alio audiocodex.

APPENDIX E: Additional information.

NOTE: This equipment complies with the limits for a Class A digital device, pursuant to part 15 of the **FCC** Rules. These limits are designed to provide reasonable protection against harmful interference when the equipment is operated in a commercial environment. This equipment generates, uses, and can radiate radio frequency energy and, if not installed and used in accordance with the instruction manual, may cause harmful interference to radio communications. Operation of this equipment in a residential area is likely to cause harmful interference in which case the user will be required to correct the interference at his own expense.